

Smarter®



LIGHTING CATALOG **Edition 2022**

Smarter[®]

Edition 2022



ISO 9001
Certificat Nr. 6501



www.smarterlight.ro



Lighting solutions which guarantee the right quality, capable of providing a smile of satisfaction.

A collection of modern and accessible indoor and outdoor fixtures, suitable for a wide range of users and applications. Smarter represents a practical and reliable solution.

New shapes, new materials, new styles and ways of lighting to find your own luminous expression, in tune with your taste and the latest trends.

Soluții de iluminat care garantează calitatea potrivită, capabile să ofere un zâmbet de satisfacție.

O colecție de corpuri moderne și accesibile pentru interior și exterior, potrivite pentru o gamă largă de utilizatori și aplicații. Smarter reprezintă o soluție practică și fiabilă. Forme noi, materiale noi, stiluri și moduri de iluminare noi pentru a-ți găsi propria expresie luminoasă, în ton cu gustul tău și cu ultimele tendințe.

Soluzioni luminose con la garanzia della giusta qualità capaci di regalare un sorriso di soddisfazione.

Una collezione di luci per interni ed esterni, attuali ed accessibili, adatte ad un'ampia gamma di utenti e di applicazioni. Smarter rappresenta una soluzione pratica ed affidabile. Nuove forme, nuovi materiali, nuovi stili e modalità di illuminazione per trovare la propria espressione luminosa in sintonia con il proprio gusto e le ultime tendenze.



CHAPTER INDEX

33	MODERN
189	VINTAGE
201	CLASSIC
227	WALL & CEILING
289	SPOTLIGHTS
315	FOR KIDS
327	BATHROOM
347	RECESSED DOWNLIGHTS
383	OUTDOOR

ALPHABETICAL INDEX

Aeris	142	Duke	126	Kato	82
Amber	306	Easy	148	Kim	132
Amon	336	Edison	112	Kimono	86
Andes	236	Edmond	424	Klee	40
Aragon	262	ELC 015	370	Kleidi	130
Arcadia	160	ELC 104	365	Knob	254
Aspera	206	ELC 127	370	Koa	83
Asti LED	390	ELC 146	363	Krill	196
Astrid	156	ELC 229	363	Kuna	265
Avance	332	ELC 307	366	Lamon	54
Avignon	452	ELC 329	369	Larry	190
Axis	78	ELC 1101	381	Ledo	334
Azuki	240	ELC 1104	381	Linea	415
Azul	238	ELC 2374	362	Lokki	420
Bari	440	ELC 3072	367	Lua	177
Basket	294	Ella	212	Lucino	266
Bobo	171	Embo	384	Lumo	72
Bolero	204	Emerald	258	Lunar	342
Bonn	401	Eolo	316	Magis	304
Bowie	308	Evo	414	Marano	400
Bremen	444	Ewa	213	Marker	335
Brille	264	Fabiola	216	Matera	446
Bristol	428	Five	178	Melia	152
Butterfly	164	Flora	260	Melton	442
Cage	402	Focus	397	Memo	250
Cairo	220	Formi	100	Mercury	62
Cameo	290	Four	183	Mesh	60
Cigno	66	Galax	244	Metis	158
Cilly	179	Gallileo	88	Midas	394
Cocoon	268	Giorgia	202	Mistral	68
Coline	162	Giro	56	Moon	345
Colonna	416	Glam	312	MT 101	369
Connect	34	Glenn	186	MT 112	368
Cosi	286	Gossip	76	MT 115 LED	354
CR 18 CH	372	Happy Plane	320	MT 116 LED	354
CR 27	374	Hipno	259	MT 117 LED	359
CR 34 LED	373	Home	181	MT 118 LED	359
CR 35 LED	373	Ibis	344	MT 119 LED	358
CR 36	375	Ilusio	150	MT 120 LED	358
Dalma	409	Indua	104	MT 122	364
Danubia	422	Inge	184	MT 123	364
Dao	330	Irudo	172	MT 124 LED	356
Dekra	302	Iside	272	MT 125 LED	356
Dreamer	256	Kate	277	MT 126 LED	357

MT 127 LED	357	Saris	74	Upper	119
MT 128 LED	352	Saville	192	Vanilla	106
MT 129 LED	353	Scan	396	Verena	252
MT 137 LED	378	Scott	432	Verner	222
MT 138 LED	379	Scudo	391	Vertigo	292
MT 141 LED	355	Sektor	270	Vigo	398
MT 142 LED	371	Selene	276	Vince	386
MT 143 LED	350	Sella	182	Virginia	280
MT 144 LED	351	Semia	124	Vivienne	122
MT 145 LED	350	Sevilla	448	Vortex	408
Mya	176	Sfera	410	Wiggle	170
Nebula	234	Shadow	175	Wink	388
Neptune	328	Shake	275	Wiz	87
Nido	118	Shape	136	Yak	94
Niva	116	Silma	210	Zigua	180
Nunzia	70	Sintra	44	Zing	338
Odeon	166	Sketch	90		
Odiseea	267	Snoot	129		
Optic	248	Spatha	58		
Orbital	341	Spider	96		
Peep	84	Spinner	198		
Petalo	64	Squash	242		
Pierce	120	ST 205 LED	376		
Pit	418	ST 206 LED	377		
Plana	48	Stories	322		
Playlight	324	Stratos	228		
Pluri	208	Sumo	246		
Pons	296	Sunny	274		
Pooh	138	Tabby	168		
Prisma	38	Taffi	144		
Proteus	102	Taj	80		
PT 01	360	Tamis	108		
PT 02	360	Tavel	284		
PT 03	361	Tetris	261		
PT 05	348	Tiara	214		
PT 06	349	Tim	419		
PT 07	380	Timber	146		
Qipao	98	Tirol	436		
Ra	278	Tom	310		
Riba	340	Torn	300		
Rivet	174	Tortilla	392		
Rondo	128	Tracy	163		
Ronin	298	Triad	52		
Safari	318	Triton	404		

SUSPENSIONS INDEX

SUSPENSII/SOSPENSIONI

MODERN



Aeris 142



Arcadia 160



Astrid 156



Axis 78



Butterfly 164



Cocoon 268



Coline 162



Duke 126



Edison 112



Formi 100



Gallileo 88



Giro 56



Gossip 76



Ilusio 150



Indua 104



Inge 184



Kim 132



Kimono 86

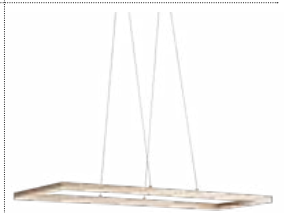

Klee 40



Kleidi 130



Lamon 54



Lumo 72



Melia 152



Metis 158



Mistral 68



Nido 118



Niva 116



Nunzia 70



Odeon 166



Peep 84



Pierce 120

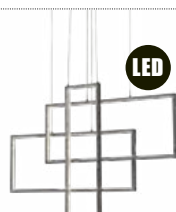

Plana 48



Pooh 138



Proteus 102



Qipao 98



Ronin 298



Saris 74



Sektor 270



Sintra 44



Sketch 90



Snoot 129

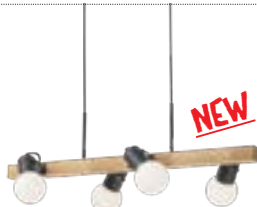

Taffi 144



Tamis 108



Timber 146



Tracy 163



Triad 52



Upper 119



Vanilla 106



Vertigo 292



Wiz 87

VINTAGE



Krill 196



Larry 190



Saville 192



Spinner 198



SUSPENSIONS INDEX

SUSPENSII/SOSPENSIONI

CLASSIC



Aspera 206



Bolero 204



Ewa 213



Fabiola 216



Giorgia 202



Verner 222



Virginia 280



Giorgia 202















Aspera 206

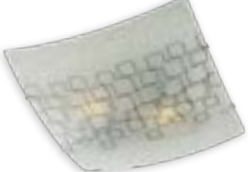

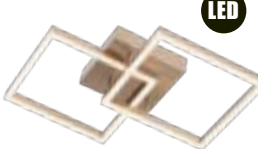
CEILING LAMPS INDEX

PLAFONIERE/PLAFONIERE

<p>MODERN</p>	 <p>Amber 306</p>	 <p>Andes 236</p>	 <p>Aragon 262</p>	 <p>Axis 78</p>
 <p>Azuki 240</p>	 <p>Azul 238</p>	 <p>Basket 294</p>	 <p>Bowie 308</p>	 <p>Brille 264</p>
 <p>Cameo 290</p>	 <p>Cigno 66</p>	 <p>Cocoon 268</p>	 <p>Connect 34</p>	 <p>Dekra 302</p>
 <p>Dreamer 256</p>	 <p>Easy 148</p>	 <p>Edison 112</p>	 <p>Emerald 258</p>	 <p>Eolo 316</p>
 <p>Flora 260</p>	 <p>Galax 244</p>	 <p>Glam 312</p>	 <p>Hipno 259</p>	 <p>Indua 104</p>
 <p>Iside 272</p>	 <p>Kate 277</p>	 <p>Kato 82</p>	 <p>Kim 132</p>	 <p>Klee 40</p>
 <p>Knob 254</p>	 <p>Koa 83</p>	 <p>Kuna 265</p>	 <p>Lucino 266</p>	 <p>Magis 304</p>



Melia 152



Memo 250



Mercury 62

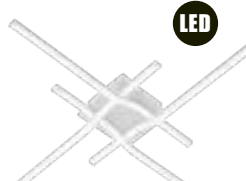

Mesh 60

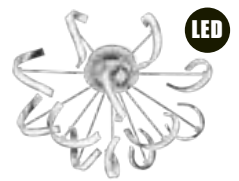

Mistral 68



Nebula 234



Nunzia 70



Odisea 267



Optic 248



Petal 64

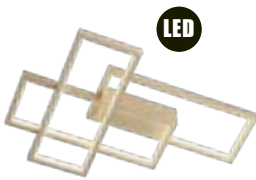

Plana 48



Pluri 208



Pons 296



Pooh 138



Prisma 38



Ra 278



Rondo 128



Ronin 298



Saris 74



Sektor 270



Selene 276



Semia 124



Shake 275



Shape 136



Sintra 44



Sumo 246



Spatha 58



Spider 96



Squash 242

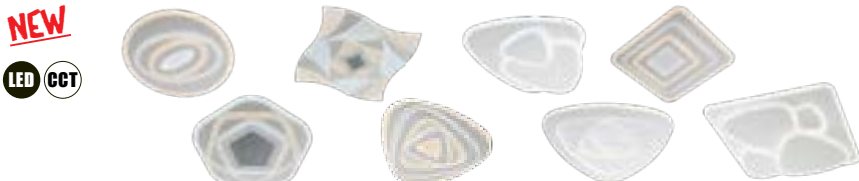

Stratos 228



Sunny 274



CEILING LAMPS INDEX

PLAFONIERE/PLAFONIERE

MODERN



Taffi 144



Taj 80



Tamis 108



Tavel 284



Tetris 261



Timber 146



Tom 310



Torn 300



Tortilla 392



Verena 252



Vertigo 292



Vivienne 122



Yak 94

CLASSIC



Aspera 206



Cosi 286



Ella 212



Pluri 208



Silma 210



Tiara 214



Virginia 280

BATHROOM



Amon 336



Ibis 344



Lunar 342



Moon 345



Orbital 341



Riba 340



Zing 338

FOR KIDS LAMPS INDEX

ILUMINAT PENTRU CAMERA COPIILOR/ILLUMINAZIONE PER BAMBINI



Eolo 316



Happy Plane 320



Playlight 324



Safari 318



Stories 322



Safari 318

WALL LAMPS INDEX

APLICE/APPLIQUE

MODERN



Aeris 142



Amber 306



Astrid 156



Axis 78



Basket 294



Bowie 308



Brille 264



Cameo 290



Cigno 66



Cocoon 268



Connect 34



Dekra 302



Dreamer 256



Duke 126



Easy 148



Edison 112



Emerald 258



Eolo 316



Flora 260



Glam 312



Hipno 259



Indua 104



Iside 272

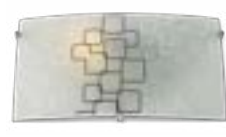

Kate 277



Kim 132



Klee 40



Kuna 265



Lumo 72



Magis 304



Melia 152



Mercury 62



Odisea 267



Peep 84



Petal 64

LED
LIGHT COLOR:
TEMPERATURE
CONTROL
3000/4000/6000K



Pierce 120



Plana 48



Pluri 208



Pons 296



Pooh 138



Prisma 38



Ra 278



Rondo 128



Ronin 298



Sektor 270



Selene 276



Semia 124



Shake 275



Shape 136



Sintra 44



Sketch 90



Spatha 58



Spider 96



Taffi 144



Tamis 108



Tetris 261



Timber 146



Melia 152

WALL LAMPS INDEX

APLICE/APPLIQUE

MODERN

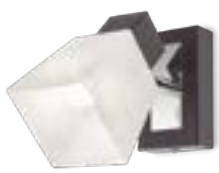

Tom 310



Torn 300



Vanilla 106



Vertigo 292



Vivienne 122



Wiggle 170



Yak 94

VINTAGE



Krill 196



Larry 190



Saville 192



Spinner 198



Pluri 208

CLASSIC



Aspera 206



Bolero 204



Cairo 220



Cosi 286



Ella 212



Fabiola 216



Pluri 208



Tiara 214



Verner 222



Virginia 280

BATHROOM

LED IP20



Avance 332

LED IP44



Dao 330

LED IP44



Ledo 334

LED IP44



Marker 335

LED IP44



Neptune 328



Dao 330

TABLE LAMPS INDEX

VEIOZE / LAMPADE DA TAVOLO

MODERN



Arcadia 160



Astrid 156



Bobo 171



Cilly 179



Five 178



Four 183



Home 181



Inge 184



Irudo 172



Melia 152



Peep 84



Playlight 324



Pooh 138



Rivet 174



Sella 182



Shadow 175



Sintra 44



Tabby 168



Wiggle 170



Zigua 180



Tabby 168

CLASSIC



Fabiola 216



Lua 177



Mya 176



Rivet 174



Shadow 175

FLOOR LAMPS INDEX

LAMPADARE /PIANTANE

MODERN



Astrid 156



Glenn 186



Inge 184



Irudo 172

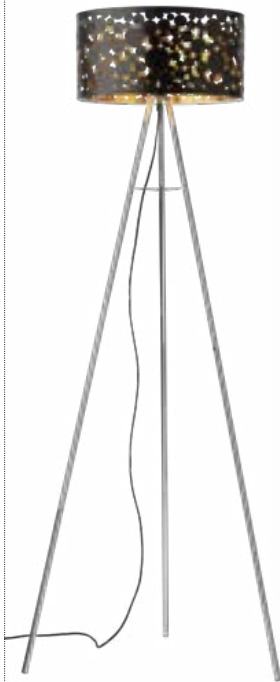

Melia 152



Peep 84



Pooh 138

CLASSIC



Fabiola 216

RECESSED DOWNLIGHTS INDEX

SPOTURI ÎNCASTRATE/INCASSI A SOFFITTO



CR 18 CH 372



CR 27 374



CR 34 LED 373



CR 35 LED 373



CR 36 375



ELC 015 370



ELC 104 365

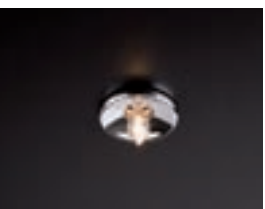

ELC 127 370



ELC 146 363



ELC 229 363



ELC 307 366

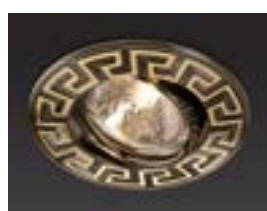

ELC 329 369



ELC 1101 381



ELC 1104 381



ELC 2374 362



ELC 3072 367



MT 101 369



MT 112 368



MT 115 LED 354



MT 116 LED 354



MT 117 LED 359



MT 118 LED 359



MT 119 LED 358



MT 120 LED 358



MT 122 364



MT 123 364



MT 124 LED 356



MT 125 LED 356



MT 126 LED 357



MT 127 LED 357



MT 128 LED 352



MT 129 LED 353



MT 137 LED 378



MT 138 LED 379



MT 141 LED 355



MT 142 LED 371



MT 143 LED 350



MT 144 LED 351



MT 145 LED 350



PT01 360



PT02 360



PT03 361



PT05 348



PT06 349



PT07 380



ST 205 LED 376



ST 206 LED 377

OUTDOOR SUSPENSIONS INDEX

SUSPENSII PENTRU EXTERIOR/SOSPENSIONI PER ESTERNI

CLASSIC



Avignon 452



Bari 440



Bremen 444



Bristol 428



Edmond 424



Matera 446



Melton 442



Scott 432



Sevilla 450



Tiroi 436

OUTDOOR CEILING LAMPS INDEX

PLAFONIERE PENTRU EXTERIOR/PLAFONIERE PER ESTERNI

MODERN



Focus 397



Sfera 410



Triton 404



Vigo 398



Tirol 436



Tortilla 392



Sfera 410

OUTDOOR WALL LAMPS INDEX

APLICE PENTRU EXTERIOR/APPLIQUE PER ESTERNI

MODERN



Asti LED 390



Bonn 401



Cage 402



Colonna 416



Dalma 409



Danubia 422



NEW
LED
Embo 384



Evo 414



Focus 397



Linea 415



Marano 400



NEW
Midas 394



Scan 396



LED
Scudo 391



Sfera 410



Triton 404



LED
Vince 386



Vortex 408



NEW
Wink 388



Triton 404

CLASSIC

**Avignon** 452**Bari** 440**Bremen** 444**Bristol** 428**Edmond** 424**Matera** 446**Melton** 442**Scott** 432**Sevilla** 448

OUTDOOR POLES INDEX

STLÂPI PENTRU EXTERIOR/PALI PER ESTERNI

MODERN



Colonna 416

NEW
LED



Embo 384

NEW



Midas 394



Sfera 410

NEW



Triton 404

CLASSIC



Bari 440



Bremen 444



Bristol 428



Edmond 424



Matera 446



Melton 442



Sevilla 448



Scott 432



Tirol 436

PROJECTORS INDEX

PROIECTOARE/PROIETTORI



Pit 418



Tim 419

OUTDOOR RECESSED LAMPS INDEX

SPOTURI ÎNCASTRATE PENTRU EXTERIOR/INCASSI PER ESTERNI



Lokki 420



Lokki 420



MODERN

Connect



Light fixtures for indoor equipped with SMD LEDs, structure in aluminium and metal painted in sand white, sand black or bronze, opal PVC diffuser.

RO · Corpuri de iluminat pentru interior echipate cu LED-uri SMD, structură din aluminiu și metal vopsită alb mat, negru mat sau cu finisaj bronz, dispersor din PVC opal.

IT · Apparecchi per interni equipaggiati con LED SMD, struttura in alluminio e metallo verniciata bianco opaco, nero opaco o con finitura bronzo, diffusore in PVC opale.

RU · Светильники для интерьера, оснащенные светодиодами SMD, структура из алюминия и металла, с покраской в матовый белый, матовый черный цвет или с бронзовой отделкой, опаловый ПВХ-рассеиватель.

HU · Beltéri lámpa testek, SMD LED-el szerelve, matt fehér, matt fekete vagy bronz alumínium és fém szerkezet, opál PVC diszperzór.

BG · Осветителни тела за интериор, оборудвани със SMD светодиоди, структура от алуминий и метал, боядисана в матово бяло, матово черно или с бронзов завършек, дифузер от опалов PVC.

SK · Interiérové svietidlá pre vybavené SMD LED diódami, konštrukcia z hliníka a kovu lakovaná v pieskovo bielej, pieskovo čiernej alebo bronzovej farbe, opálový difúzor z PVC.



01-2629



01-2628

INFO/DIMENSIONS

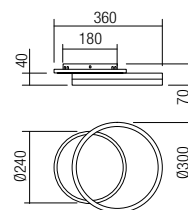

01-2628 Sand White/Sand Black
01-2629 Mat Gold

SMD LED · 28W
 3000K · CRI 80
 LED flux 3080 lm
 Luminaire flux 1540 lm





01-2634

Connect

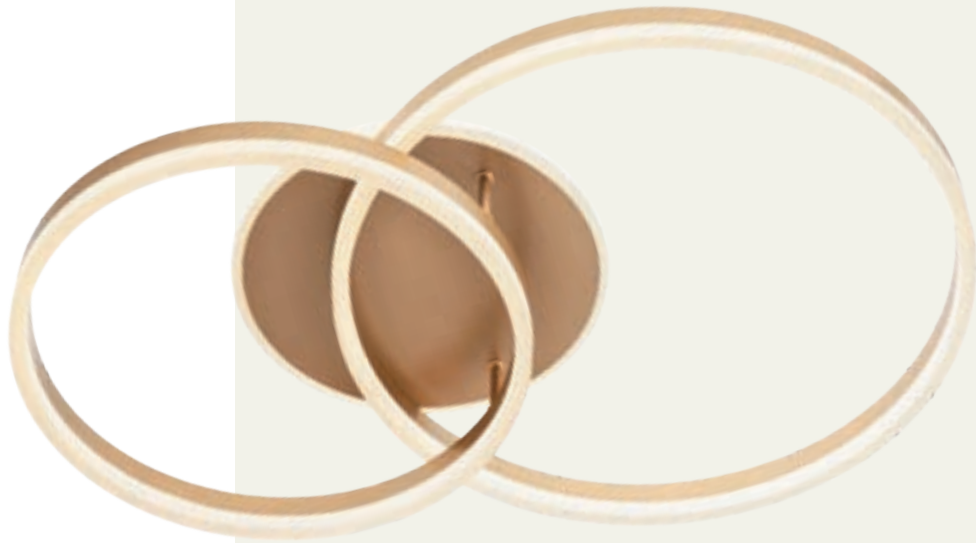

01-2631

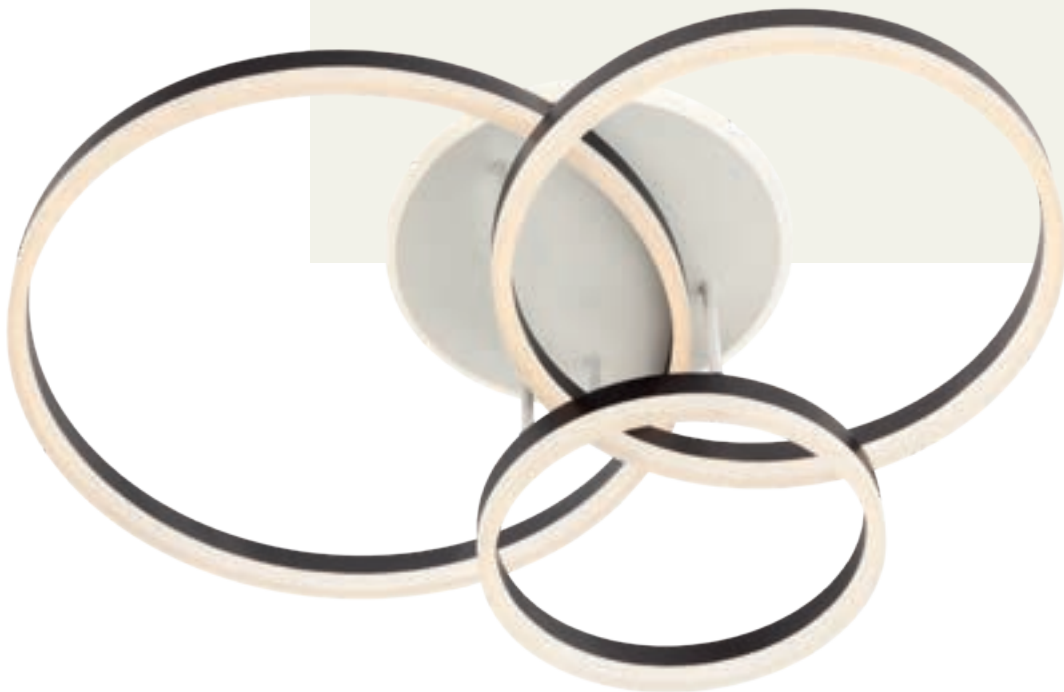

01-2632

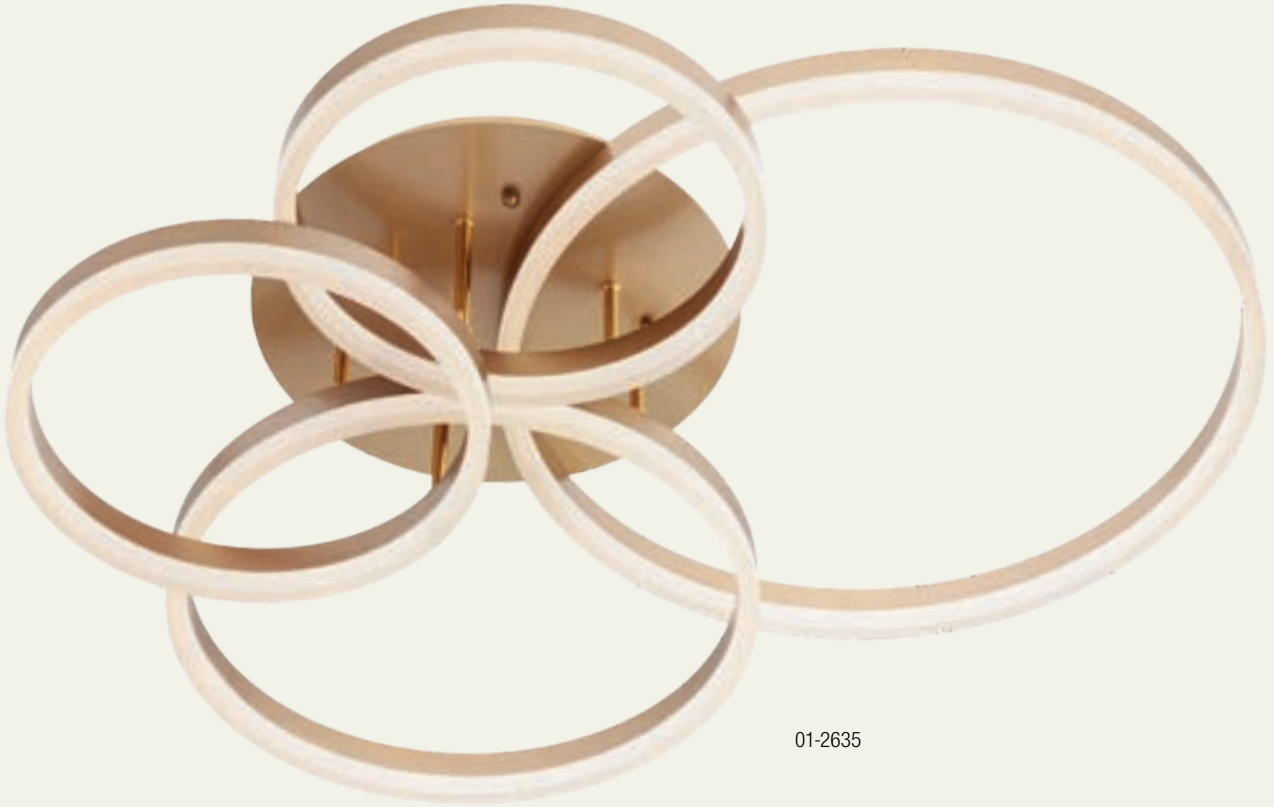

01-2635

INFO/DIMENSIONS

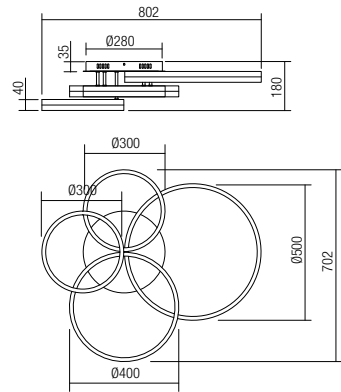
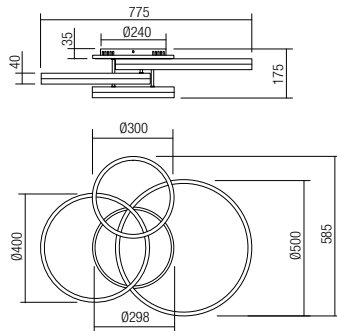
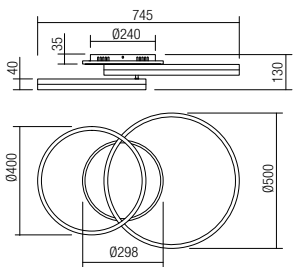

01-2630 Sand White/Sand Black
01-2631 Mat Gold

SMD LED · 70W
 3000K · CRI 80
 LED flux 7700 lm
 Luminaire flux 3850 lm



01-2632 Sand White/Sand Black
01-2633 Mat Gold

SMD LED · 90W
 3000K · CRI 80
 LED flux 9900 lm
 Luminaire flux 4950 lm



01-2634 Sand White/Sand Black
01-2635 Mat Gold

SMD LED · 90W
 3000K · CRI 80
 LED flux 9900 lm
 Luminaire flux 4950 lm



Prisma



Light fixtures for indoor equipped with SMD LEDs, structure in aluminium and metal painted in sand white, sand black or bronze, opal PVC diffuser.

RO · Corpuri de iluminat pentru interior echipate cu LED-uri SMD, structură din aluminiu și metal vopsită alb mat, negru mat sau cu finisaj bronz, dispersor din PVC opal.

IT · Apparecchi per interni equipaggiati con LED SMD, struttura in alluminio e metallo verniciata bianco opaco, nero opaco o con finitura bronzo, diffusore in PVC opale.

RU · Светильники для интерьера, оснащенные светодиодами SMD, структура из алюминия и металла, с покраской в матовый белый, матовый черный цвет или с бронзовой отделкой, опаловый ПВХ-рассеиватель.

HU · Beltéri lámpa testek, SMD LED-el szerelve, matt fehér, matt fekete vagy bronz alumínium és fém szerkezet, opál PVC diszperzór.

BG · Осветелителни тела за интериор, оборудвани със SMD светодиоди, структура от алуминий и метал, боядисана в матово бяло, матово черно или с бронзов завършек, дифузер от опалов PVC.

SK · Interiérové svietidlá pre vybavené SMD LED diódami, konštrukcia z hliníka a kovu lakovaná v pieskovo bielej, pieskovo čiernej alebo bronzovej farbe, opalový difúzor z PVC.

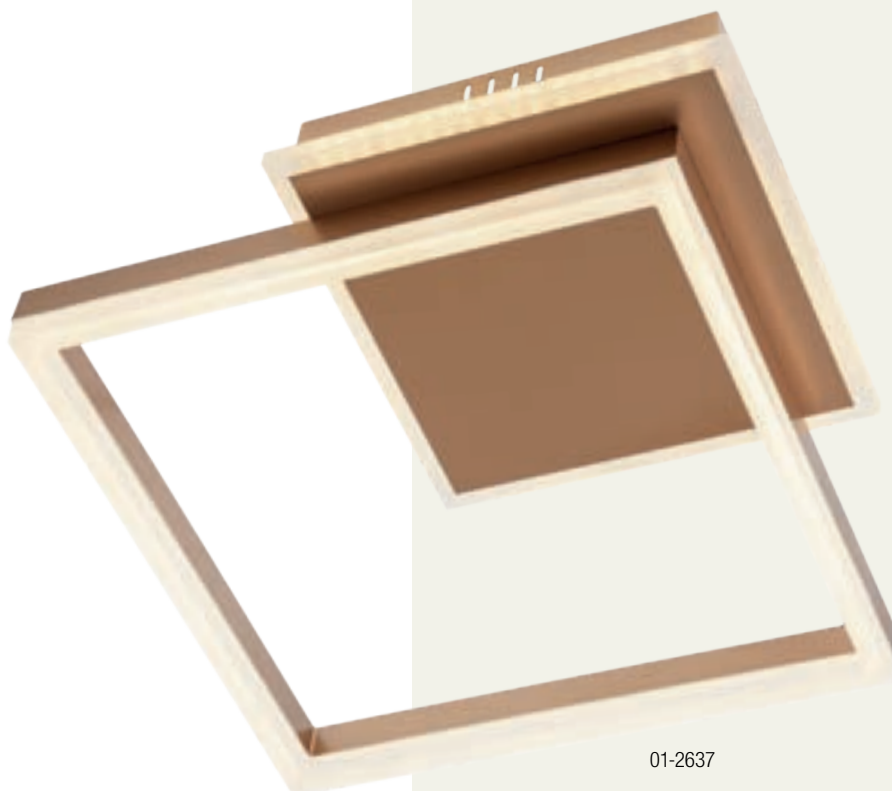

01-2637

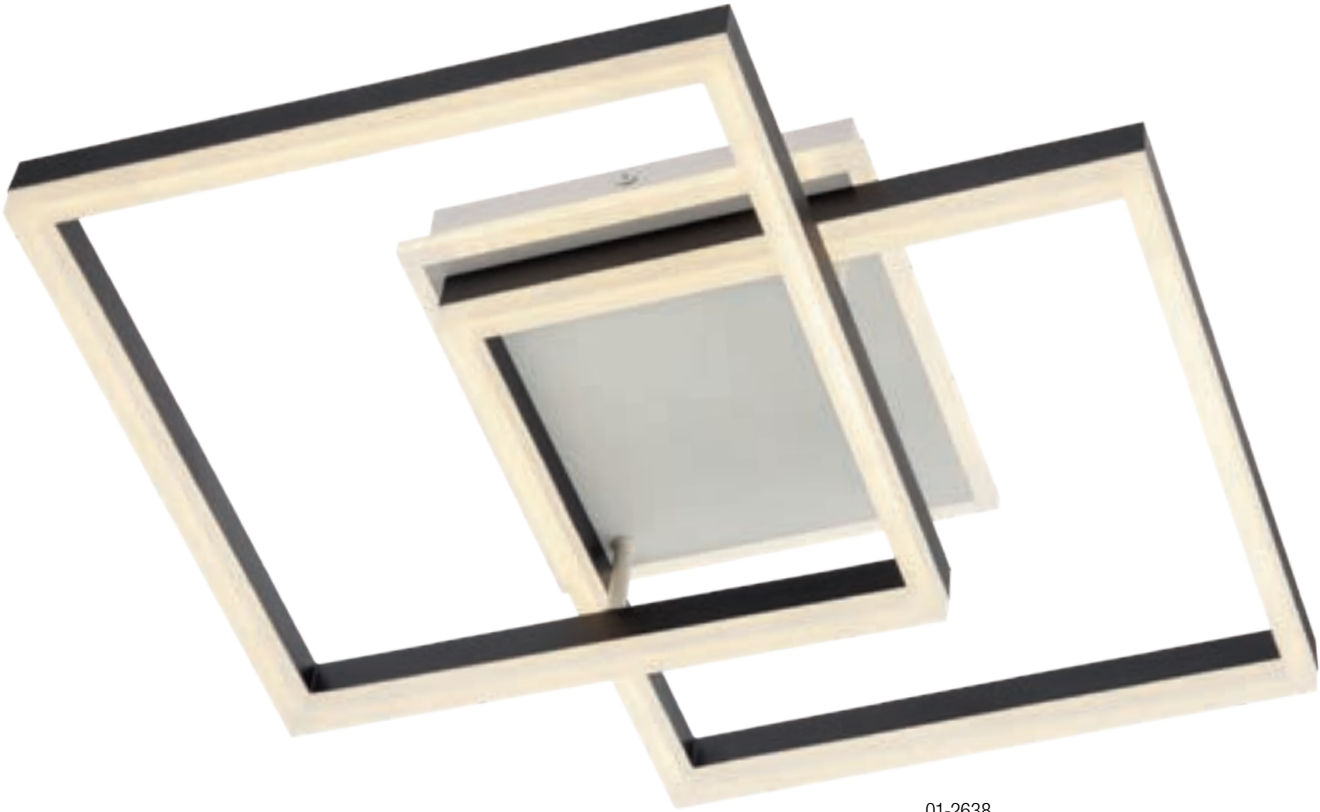

01-2638

INFO/DIMENSIONS

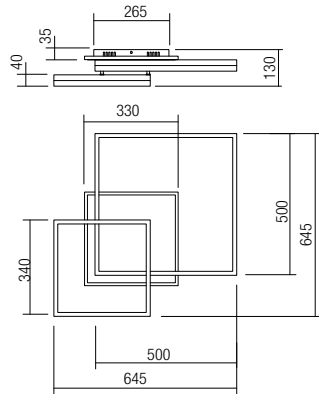
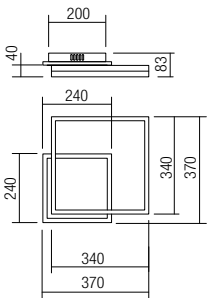

01-2636 Sand White/Sand Black
01-2637 Mat Gold

SMD LED · 37W
 3000K · CRI 80
 LED flux 4070 lm
 Luminaire flux 2200 lm



01-2638 Sand White/Sand Black
01-2639 Mat Gold

SMD LED · 79W
 3000K · CRI 80
 LED flux 8690 lm
 Luminaire flux 4740 lm





Series of lamps for indoor equipped with SMD LEDs, metal structure painted in mat white or mat gold, satin acrylic diffuser.

RO · Serie de corpuri pentru interior echipate cu led-uri SMD, structură din metal vopsit în alb mat sau auriu mat, dispersor din acril satinat.

IT · Serie di apparecchi per interni equipaggiati con LED SMD, struttura in metallo verniciato bianco opaco o oro opaco, diffusore in acrilico satinato.

RU · Серия светильников для интерьера оснащенных светодиодами SMD, структура из металла окрашенного в белый матовый или золотой матовый цвет, рассеиватель из сатирированного акрила.

HU · Beltéri lámpa testek, SMD LED-el szerelve, matt fehér vagy matt arany fémszerkezet, szatínált akril diszperzór.

BG · Серия от интериорни лампи, оборудвано с SMD диоди, метална основа, боядисана в бял или златен мат, сатенен дифузер.

SK · Sériá interiérových svietidiel, vybavených LED diódami SMD, kovová konštrukcia lakovaná v matnej bielej alebo matnej zlatej farbe, saténový akrylový difúzor.

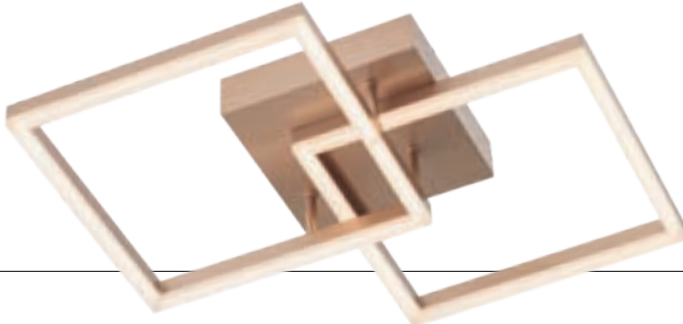

01-1641



01-1636

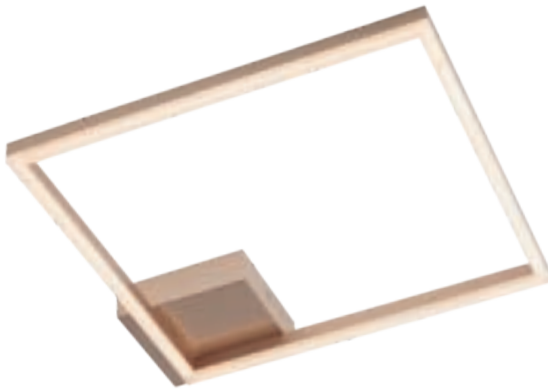

01-1639

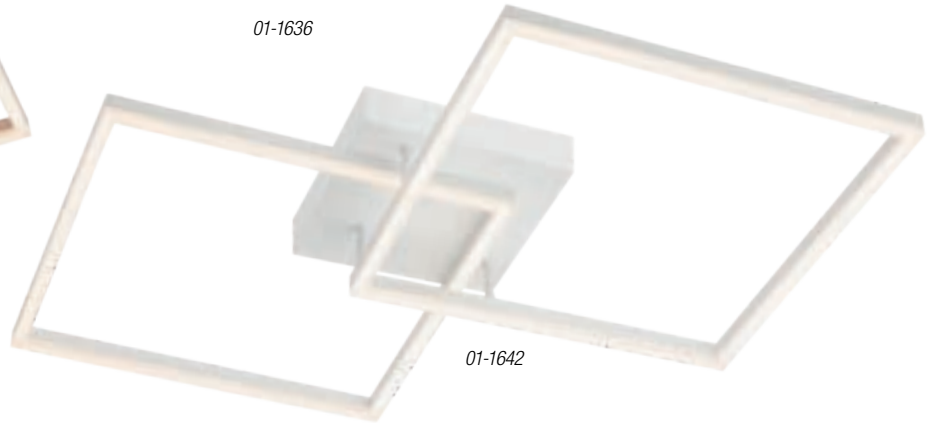

01-1642

INFO/DIMENSIONS

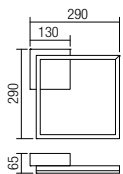

○ 01-1636 Mat White
● 01-1637 Mat Gold

SMD LED · 27W · 3000K · CRI 82
LED flux 2900 lm
Luminaire flux 1430 lm

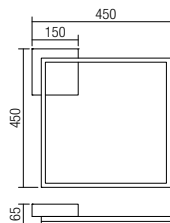

○ 01-1638 Mat White
● 01-1639 Mat Gold

SMD LED · 34W · 3000K · CRI 82
LED flux 3800 lm
Luminaire flux 2169 lm

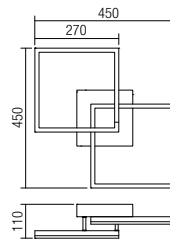
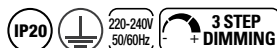

○ 01-1640 Mat White
● 01-1641 Mat Gold

SMD LED · 33W · 3000K · CRI 82
LED flux 4000 lm
Luminaire flux 2076 lm

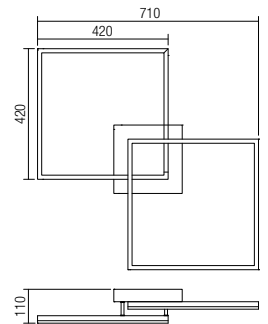

○ 01-1642 Mat White
● 01-1643 Mat Gold

SMD LED · 53W · 3000K · CRI 82
LED flux 5750 lm
Luminaire flux 3323 lm

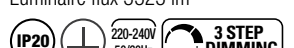



01-1637



Klee



01-1645



01-1642

INFO/DIMENSIONS

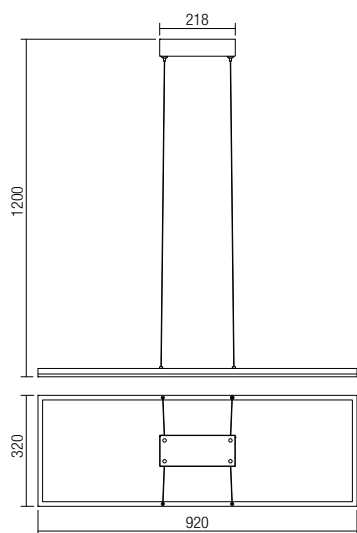

○ 01-1644 Mat White

● 01-1645 Mat Gold

SMD LED · 38W · 3000K · CRI 82

LED flux 4600 lm

Luminaire flux 2466 lm



01-1644

Sintra

Light fixtures for interior equipped with SMD LEDs, structure in aluminum and metal electrostatically painted in mat white, diffusers of opal white silicone.



RO · Corpuri de iluminat pentru interior echipate cu LED-uri SMD, structură din aluminiu și metal vopsit în câmp electrostatic alb mat, dispersoare din silicon alb opal.

IT · Serie di apparecchi per interni equipaggiati con SMD LED, struttura in alluminio e metallo verniciata a polveri bianco opaco, diffusori in silicone opalino bianco.

RU · Светильники для интерьера, оснащенные светодиодами SMD, структура из алюминия и металла, окрашена в электростатическом поле в матовый белый цвет, рассеиватели из опалового силикона белого цвета.

HU · Beltéri lámpatestek, SMD LED-el szerelve, elektrosztatikus mezőben matt fehérre festett fém szerkezet, opál szilikon diszperzór.

BG · Осветителни тела за интериор, разполагат със SMD светодиоди, структура от алуминий и метал боядисана в электростатично поле в цвят матово бяло, дифузери от бяло опалов силикон.

SK · Svietidlá do interiéru vybavené LED diódami SMD, štruktúra z hliníka a kovu elektrostaticky lakovaná matnou bielou, difúzory z opálovo bieleho silikónu.

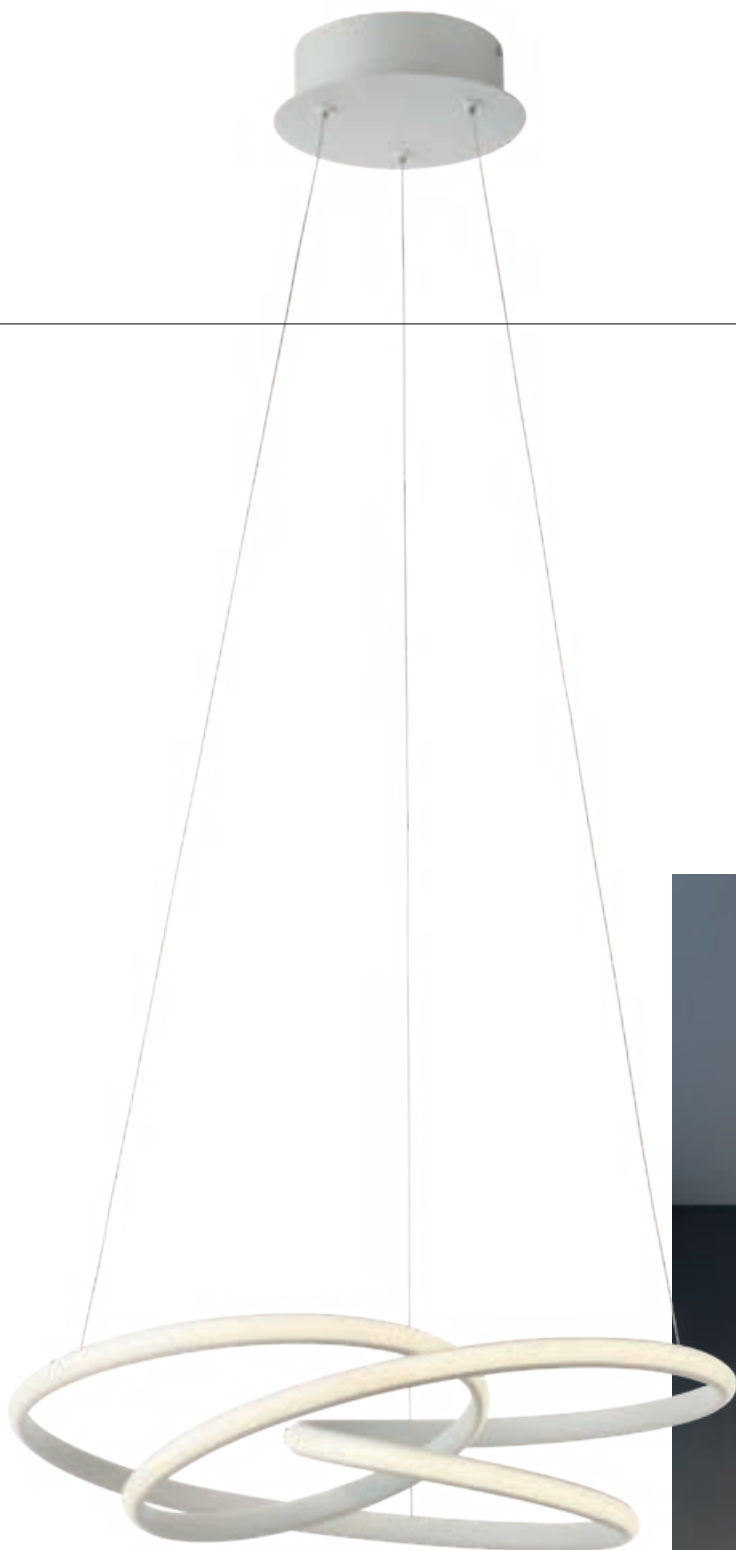

01-2190





01-2191

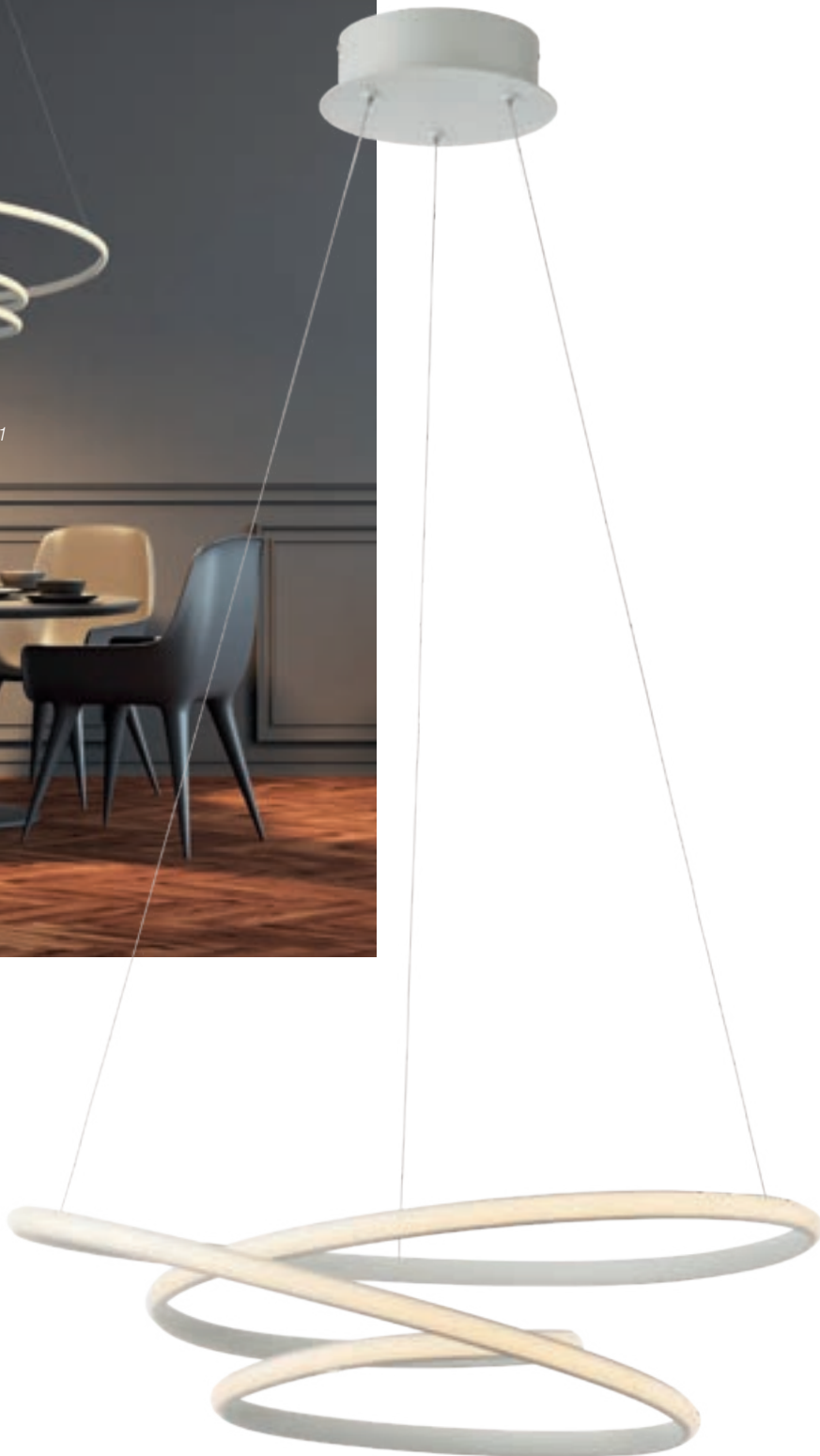

01-2191

INFO/DIMENSIONS

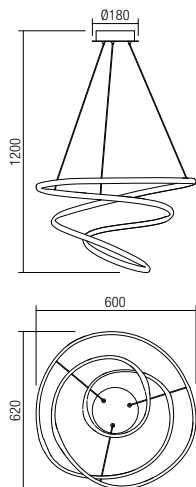
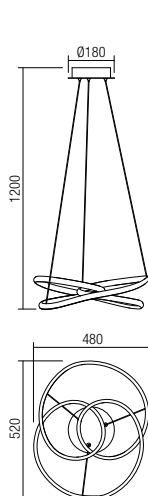
**01-2190**

SMD LED · 41W · 3000K · CRI 82
LED flux 4544 lm
Luminaire flux 2726 lm

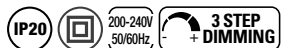
**01-2191**

SMD LED · 59W · 3000K · CRI 82
LED flux 6882 lm
Luminaire flux 3705 lm

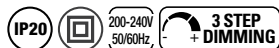



01-2189

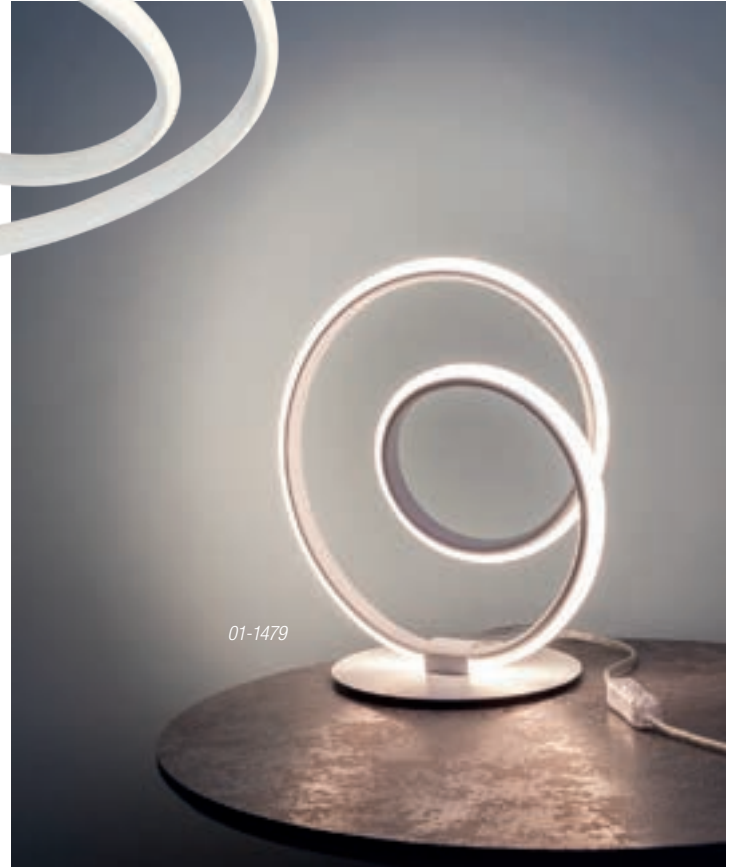

01-1479



01-2188

INFO/DIMENSIONS

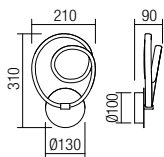

01-2188
 SMD LED · 12W · 3000K · CRI 82
 LED flux 1457 lm
 Luminaire flux 768 lm

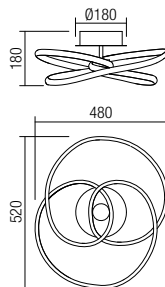

01-2189
 SMD LED · 41W · 3000K · CRI 82
 LED flux 4544 lm
 Luminaire flux 2726 lm

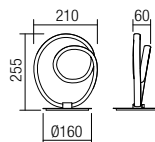

01-1479
 SMD LED · 12W · 3000K · CRI 82
 LED flux 1413 lm
 Luminaire flux 768 lm



01-1479



01-2189

Plana



Series of light fixtures for indoor equipped with SMD LEDs, structure of metal and aluminum painted in mat white or mat black or of metal and brushed aluminum painted in mat gold, white and silicone diffusers.

RO · Serie de corpuri de iluminat pentru interior echipate cu led-uri SMD, structură din metal și aluminiu vopsit alb mat sau negru mat ori din metal și aluminiu periat vopsit aur mat, dispersoare din silicon alb.

IT · Serie di apparecchi per interni equipaggiati con LED SMD, struttura in metallo e alluminio verniciato bianco opaco o nero opaco oppure in metallo e alluminio spazzolato verniciato oro opaco, diffusori in silicone bianco.

RU · Серия светильников для внутреннего освещения, оснащенных светодиодами SMD, структура из металла и алюминия, окрашена в белый матовый или черный матовый цвет или из металла и алюминия окрашенных в золотой матовый цвет, рассеиватели из белого силикона.

HU · Beltéri lámpa testek, SMD LED-el szerelve, matt fehér, matt fekete vagy matt arany fém és alumínium szerkezet, fehér szilikon diszperzör.

BG · Серия осветителни тела за интериор, оборудвани със SMD светодиоди, метална и алуминиева структура, боядисана в матово бяло или матово черно или от метал и четен алуминий, боядисана в матово злато, дифузери от бял силикон.

SK · Sériá interiérových svietidiel vybavených LED diódami SMD, štruktúra kovu a hliníka lakovaná v matnej bielej alebo matnej čiernej farbe alebo z kovu a brúseného hliníka lakovaná v matnej zlatej, biele silikónové difúzory.

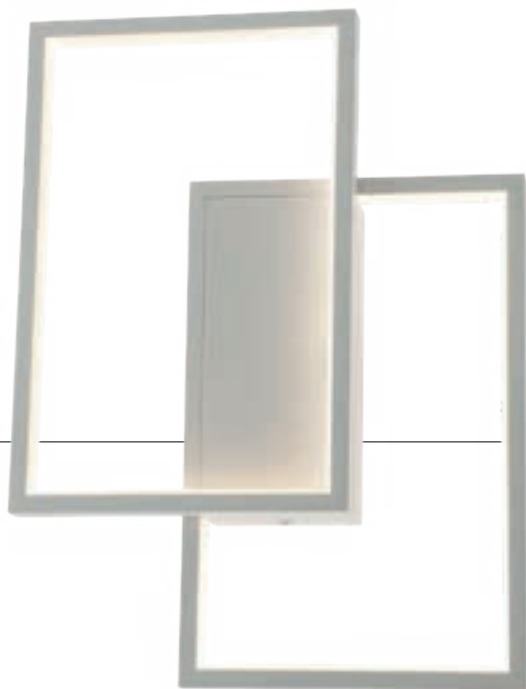

01-2304

INFO/DIMENSIONS

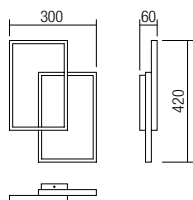

○ 01-2304 Mat White

● 01-2305 Mat Gold

● 01-2306 Mat Black

SMD LED · 30W · 3000K · CRI 80

LED flux 3626 lm

Luminaire flux 1950 lm



01-2305



01-2309

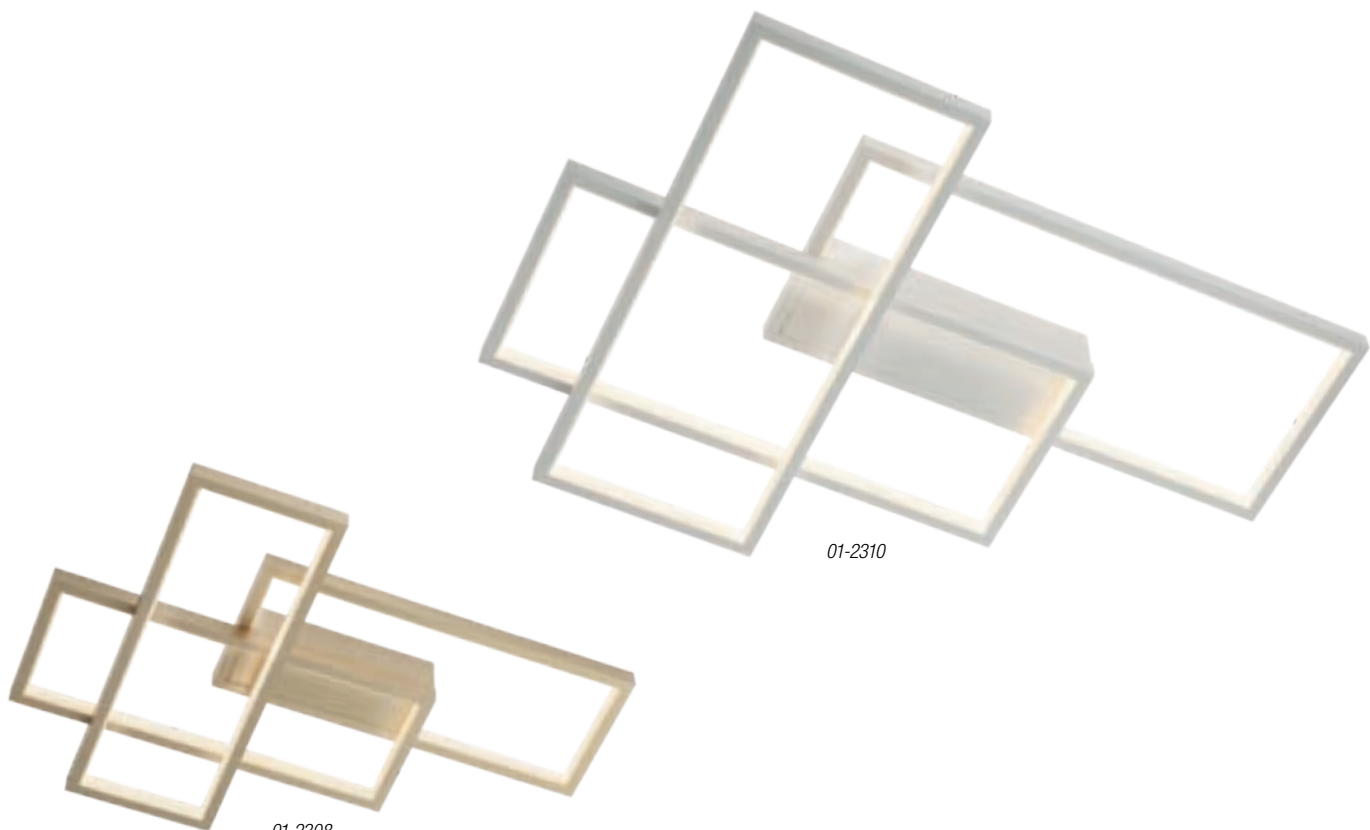

01-2310

01-2308

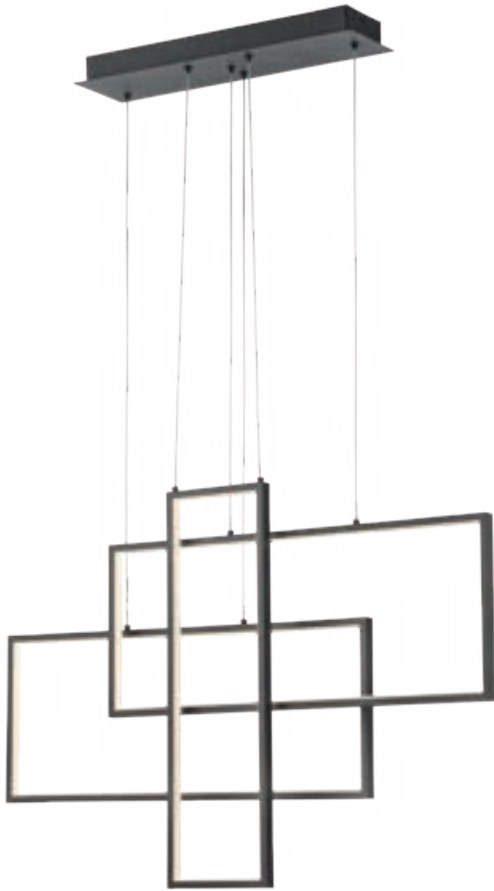

01-2315



01-2317

INFO/DIMENSIONS

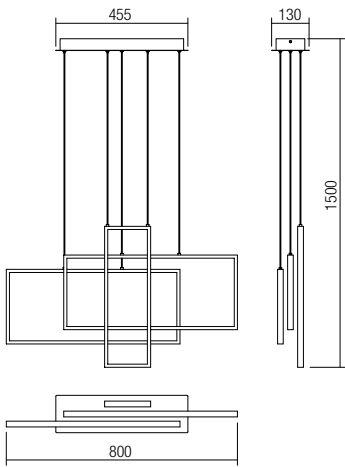

- 01-2313 Mat White
 - 01-2314 Mat Gold
 - 01-2315 Mat Black
- SMD LED · 60W · 3000K · CRI 80
 LED flux 7185 lm
 Luminaire flux 3900 lm



01-2318

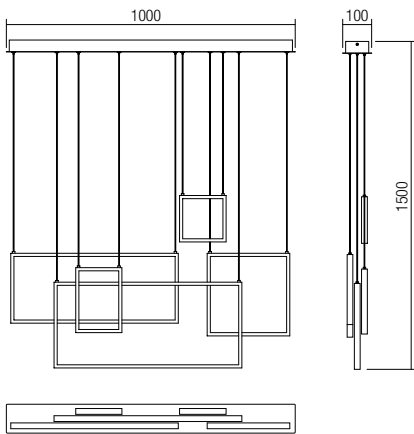

- 01-2316 Mat White
 - 01-2317 Mat Gold
 - 01-2318 Mat Black
- SMD LED · 80W · 3000K · CRI 80
 LED flux 9765 lm
 Luminaire flux 5360 lm

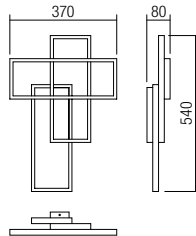

- 01-2307 Mat White
 - 01-2308 Mat Gold
 - 01-2309 Mat Black
- SMD LED · 40W · 3000K · CRI 80
 LED flux 4942 lm
 Luminaire flux 2680 lm

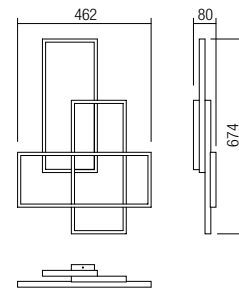

- 01-2310 Mat White
 - 01-2311 Mat Gold
 - 01-2312 Mat Black
- SMD LED · 50W · 3000K · CRI 80
 LED flux 6348 lm
 Luminaire flux 3400 lm



Triad



Suspensions for indoor equipped with SMD LEDs, structure in aluminium and metal painted in bronze, opal PVC diffuser.

RO · Suspensii pentru interior echipate cu LED-uri SMD, structură din aluminiu și metal finisată bronz, dispersor din PVC opal.

IT · Sospensioni per interni equipaggiate con LED SMD, struttura in alluminio e metallo finitura bronzo, diffusore in PVC opale.

RU · Навесные светильники для интерьера, оснащенные светодиодами SMD, структура из алюминия и металла с бронзовой отделкой, опаловый ПВХ-рассеиватель.

HU · Beltéri függesztékek, SMD LED-el szerelve, bronz színű alumínium és fém szerkezet, opál PVC diszperzór.

BG · Полилеи за интериор, разполагат със SMD светодиоди, структура от алуминий и метал, с бронзов завършек, дифузер от опалов PVC.

SK · Závěsné interiérové svietidlá vybavené SMD LED diódami, konštrukcia z hliníka a kovu lakovaného v bronzovej farbe, difúzor z opálového PVC.

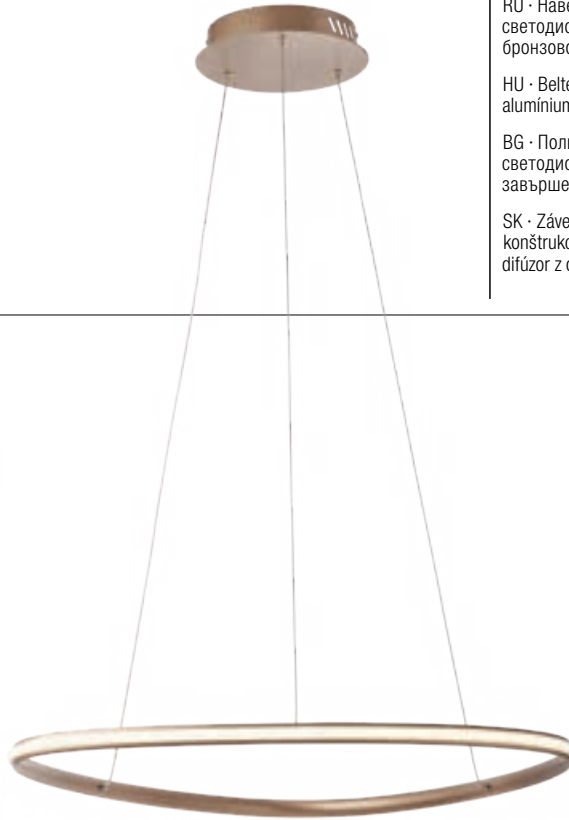

01-2456



01-2457

INFO/DIMENSIONS

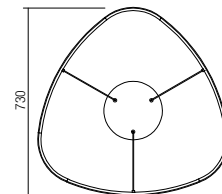
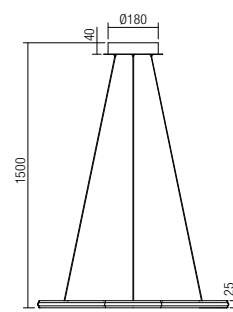
**01-2456**

SMD LED · 36W
4000K · CRI 85
LED flux 3900 lm
Luminaire flux 2007 lm

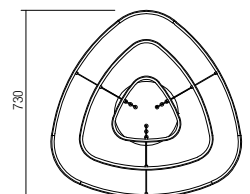
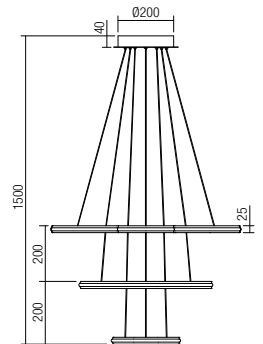
**01-2457**

SMD LED · 60W
4000K · CRI 85
LED flux 7000 lm
Luminaire flux 3808 lm





Lamon



Light fixtures for indoor equipped with SMD LEDs, structure in aluminium and metal painted in sand white, sand black or bronze, opal PVC diffuser.

RO · Corpuri de iluminat pentru interior echipate cu LED-uri SMD, structură din aluminiu și metal vopsită alb mat, negru mat sau cu finisaj bronz, dispersor din PVC opal.

IT · Apparecchi per interni equipaggiati con LED SMD, struttura in alluminio e metallo verniciata bianco opaco, nero opaco o con finitura bronzo, diffusore in PVC opale.

RU · Светильники для интерьера, оснащенные светодиодами SMD, структура из алюминия и металла, с покраской в матовый белый, матовый черный цвет или с бронзовой отделкой, опаловый ПВХ-рассеиватель.

HU · Beltéri lámpa testek, SMD LED-el szerelve, matt fehér, matt fekete vagy bronz alumínium és fém szerkezet, opál PVC diszperzór.

BG · Осветителни тела за интериор, оборудвани със SMD светодиоди, структура от алуминий и метал, боядисана в матово бяло, матово черно или с бронзов завършек, дифузер от опалов PVC.

SK · Interiérové svietidlá pre vybavené SMD LED diódami, konštrukcia z hliníka a kovu lakovaná v pieskovo bielej, pieskovo čiernej alebo bronzovej farbe, opalový difúzor z PVC.



INFO/DIMENSIONS

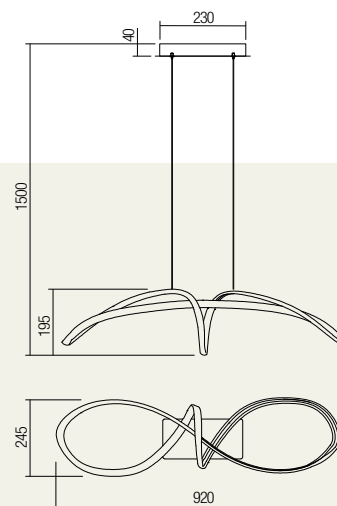

○ 01-2453 Sand White

● 01-2454 Bronze

● 01-2455 Sand Black

SMD LED · 57W

4000K · CRI 82

LED flux 6800 lm

Luminaire flux 3852 lm



01-2455



01-2454

Giro



Series of suspensions for interior equipped with SMD LEDs, structure in aluminum and metal electrostatically painted in mat white or mat black, diffuser of opal white silicone.

RO · Serie de suspensii pentru interior echipate cu LED-uri SMD, structură din aluminiu și metal vopsit în câmp electrostatic alb mat sau negru mat, dispersor din silicon alb opal.

IT · Serie di sospensioni per interni equipaggiate con SMD LED, struttura in alluminio e metallo verniciata a polveri bianco opaco o nero opaco, diffusore in silicone opalino bianco.

RU · Серия люстр для интерьера, оснащенных светодиодами SMD, структура из алюминия и металла, окрашенная в электростатическом поле в матовый белый или черный матовый цвет, рассеиватель из опалового силикона белого цвета.

HU · Beltéri függesztékek, SMD LED-el szerelve, elektrosztatikus mezőben matt fehér vagy matt feketére festett alumínium és fém szerkezet, opál szilikon diszperzór.

BG · Серия окачвания за интериор, разполагат със SMD светодиоди, структура от алуминий и метал боядисана в электростатично поле в цвят матово бяло или матово черно, дифузер от бяло опалов силикон.

SK · Séria závesných svietidiel do interiéru s LED diódami SMD, štruktúra z hliníka a kovu elektrostaticky lakovaná matnou bielou alebo matnou čiernou, difúzor z opalového bieleho silikónu.

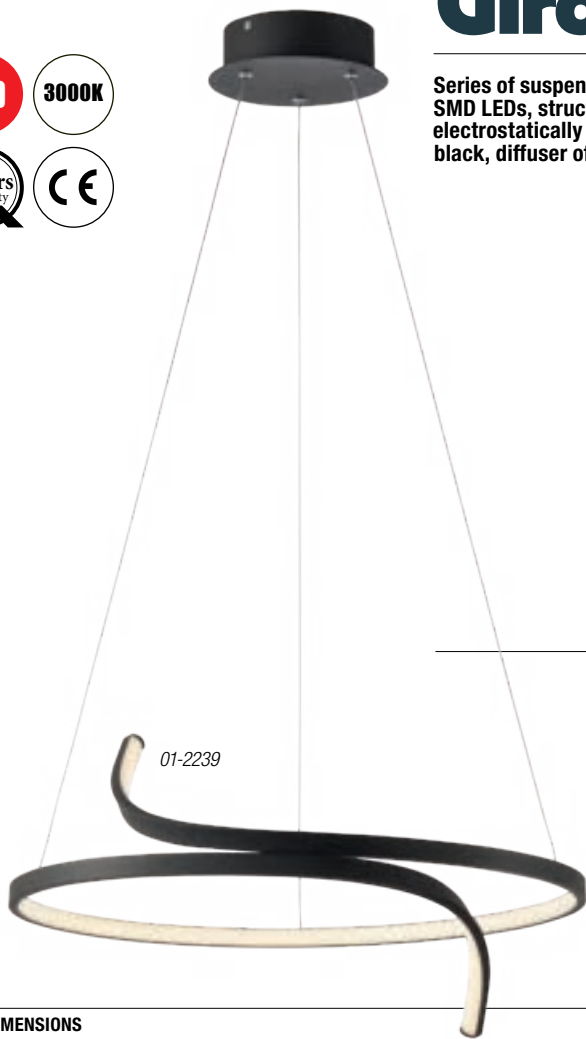

INFO/DIMENSIONS

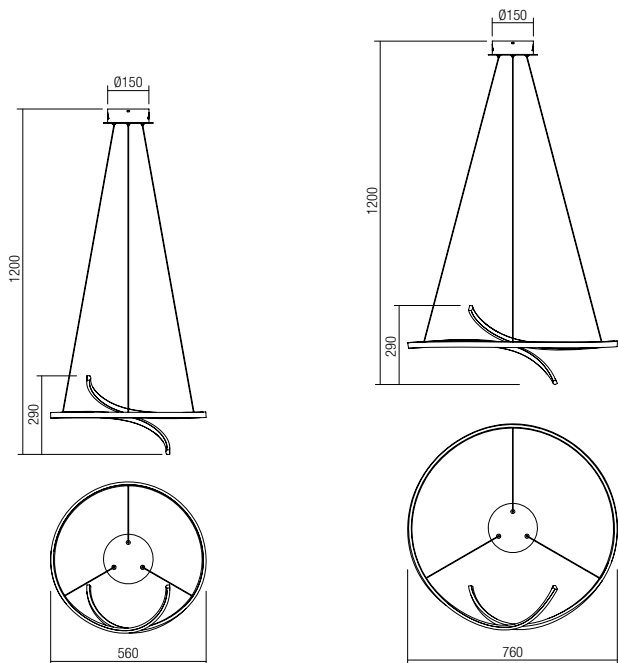

○ 01-2238 Mat White
● 01-2239 Mat Black

SMD LED · 38W · 3000K · CRI 80
LED flux 5000 lm
Luminaire flux 3024 lm



○ 01-2240 Mat White
● 01-2241 Mat Black

SMD LED · 46W · 3000K · CRI 80
LED flux 5800 lm
Luminaire flux 3456 lm



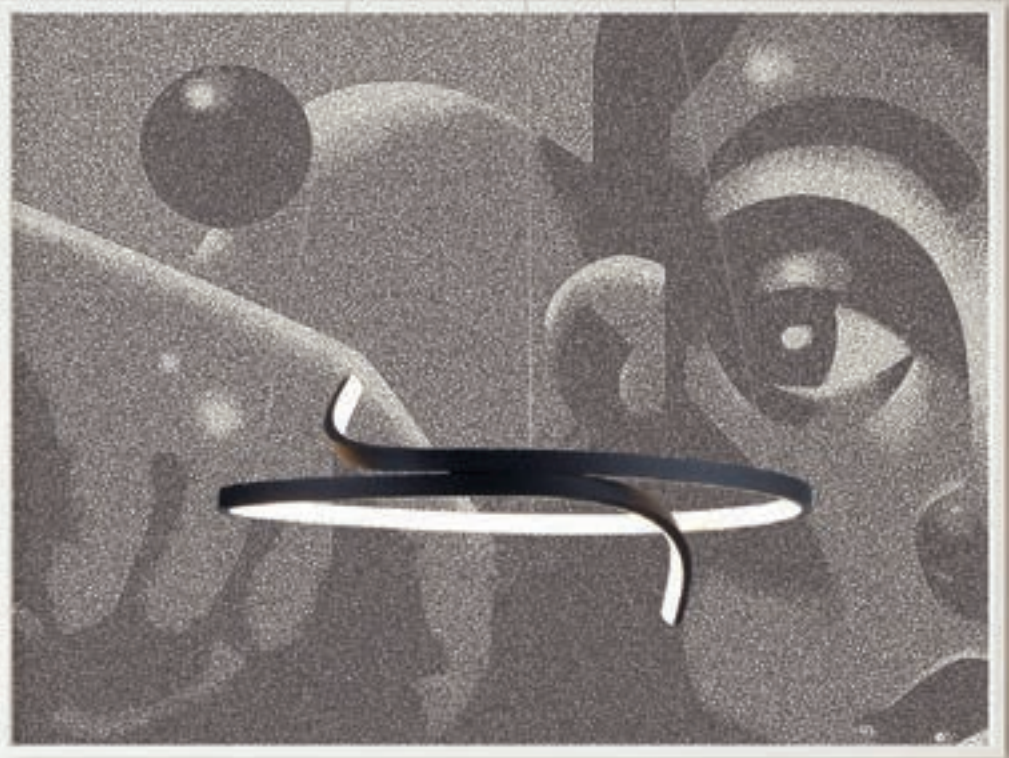

Spatha



Light fixtures for indoor equipped with SMD LEDs, aluminum structure painted in mat white or finished in gold foil, opal polycarbonate diffusers.

RO · Serie de corpuri de iluminat pentru interior echipate cu LED-uri SMD, structură din aluminiu vopsită alb mat sau finisată folie aur, dispersoare din policarbonat opal.

IT · Apparecchi per interni equipaggiati con LED SMD, struttura in alluminio verniciato bianco opaco o finitura foglia oro, diffusori in policarbonato opale.

RU · Светильники для внутреннего освещения, оснащенные светодиодами SMD, алюминиевая конструкция, окрашена в белый матовый цвет или отделанна сусальным золотом, рассеиватели из опалового поликарбоната.

HU · Beltéri lámpatestek, SMD LED-el szerelve, fehér vagy arany fóliával borított alumínium szerkezet, polikarbonát opál diszperzór.

BG · Серия осветителни тела за интериор, разполага със SMD светодиоди, структура от алуминий боядисана в цвят матово бяло или с покритие от златно фолио, дифузери от опалов поликарбонат.

SK · Svetidlá pre interiéry vybavené LED diódami SMD, hliníková konštrukcia lakovaná matnou bielou alebo povrchovo upravená zlatou fóliou, opálové polykarbonátové difúzory.



01-2184

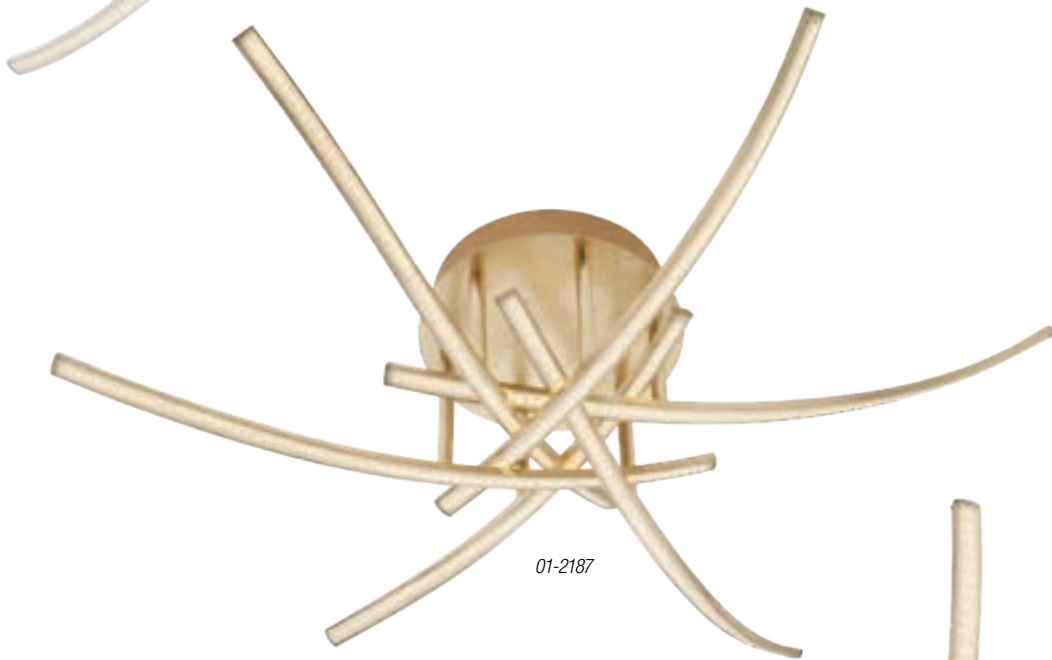

01-2187



01-2183

INFO/DIMENSIONS

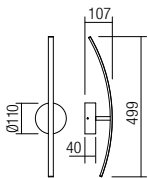

○ 01-2182 Mat White
● 01-2183 Gold Foil

SMD LED · 6W · 3000K · CRI 82
LED flux 676 lm
Luminaire flux 408 lm

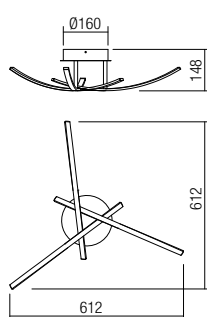

○ 01-2184 Mat White
● 01-2185 Gold Foil

SMD LED · 18W · 3000K · CRI 82
LED flux 1857 lm
Luminaire flux 1224 lm

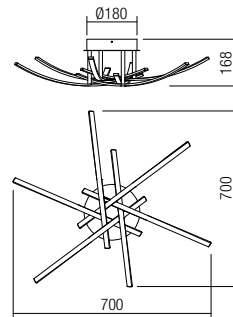

○ 01-2186 Mat White
● 01-2187 Gold Foil

SMD LED · 36W · 3000K · CRI 82
LED flux 3687 lm
Luminaire flux 2398 lm



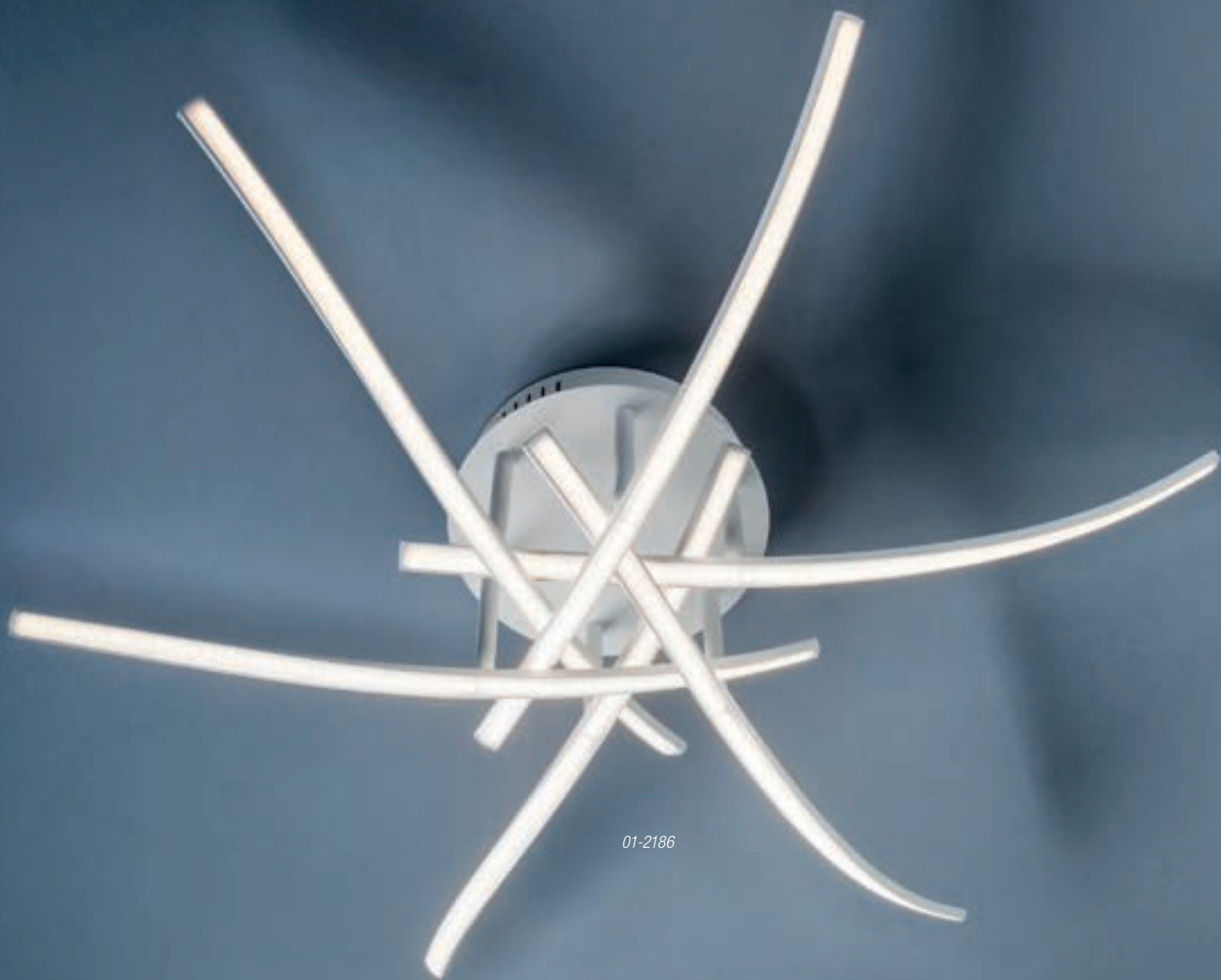

01-2186

Mesh



Ceiling lamp for indoor equipped with SMD LEDs, metal structure painted in mat white, satin PVC diffuser.

RO · Plafonieră pentru interior echipată cu LED-uri SMD, structură din metal vopsit alb mat, dispersor din PVC satinat.

IT · Plafoniera per interni equipaggiata con LED SMD, struttura in metallo verniciato bianco opaco, diffusore in PVC satinato.

RU · Потолочный светильник для внутреннего освещения, оснащенный светодиодами SMD, металлическая структура, окрашенная в белый матовый цвет, рассеиватель из сатинового ПВХ.

HU · Beltéri mennyezeti lámpák, SMD LED-el ellátva, matt fehér fémszerkezet, szatin PVS diszperzór.

BG · Интериорно осветително тяло за таван с SMD LED платка, метален корпус в бял мат, матов PVC дифузер.

SK · Stropná lampa pre vnútorné osvetlenie s LED diódami SMD, kovová konštrukcia lakovaná v matnej bielej farbe, saténový difúzor z PVC.

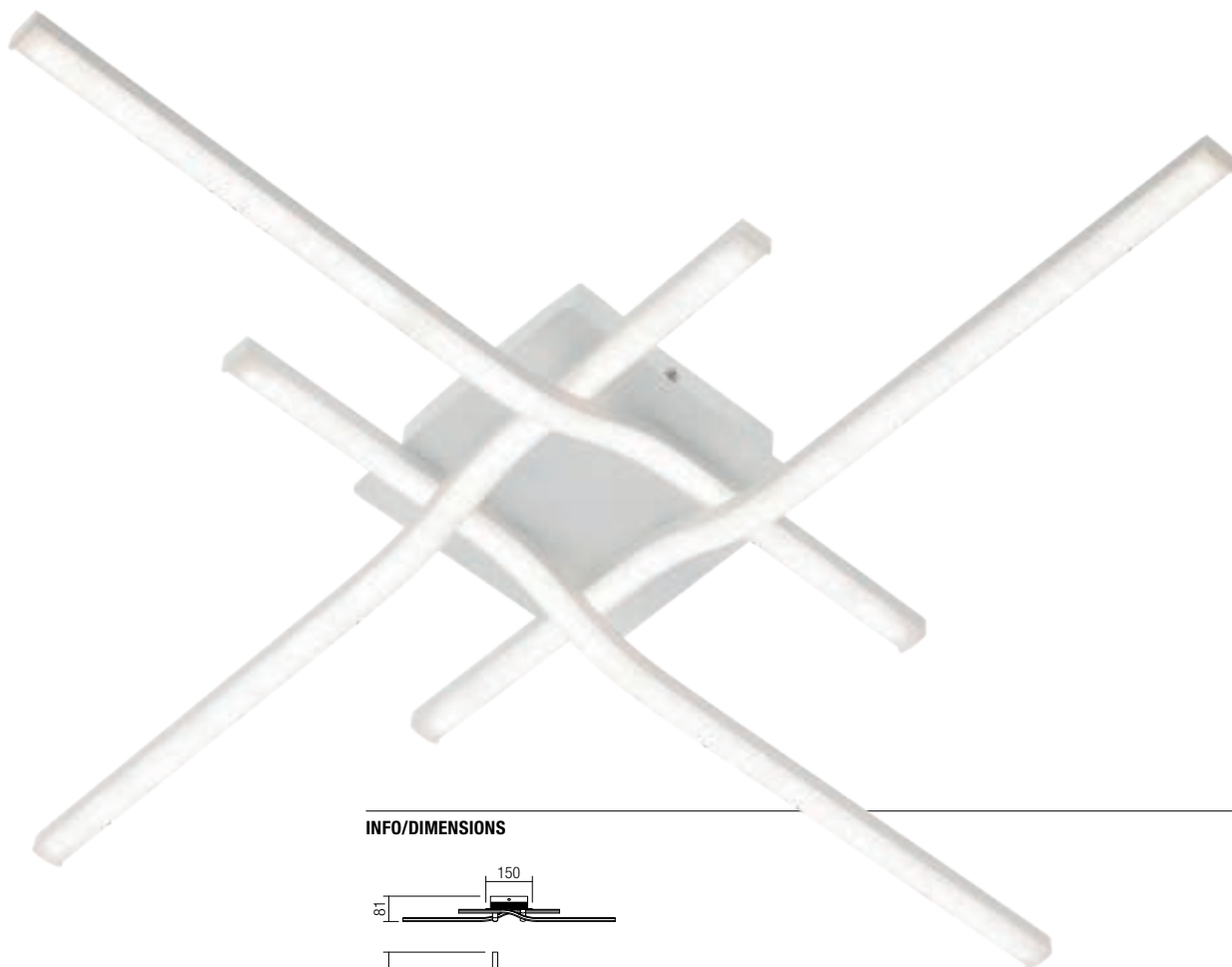

INFO/DIMENSIONS

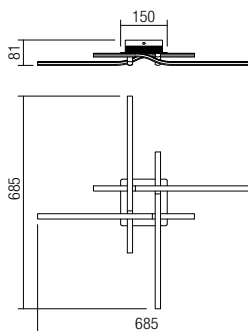

01-1621

SMD LED · 40W · 4000K · CRI 82

LED flux 5500 lm

Luminaire flux 3017 lm





Mercury



Series of light fixtures for indoor equipped with SMD LEDs, metal structure painted in mat white, satin acrylic diffusers. The ceiling lamps are delivered with remote control (2 AAA batteries included) with multiple functions: ON/OFF, 3 operating programs, light intensity regulation, variation of the color temperature from warm white to cool white, timer and night light mode.

RO - Serie de corpuri de iluminat pentru interior echipate cu led-uri SMD, structură din metal vopsit alb mat, dispersoare din acril satinat. Plafonierele sunt livrate cu telecomandă (cu 2 baterii AAA incluse) cu următoarele funcții: ON/OFF, 3 programe de funcționare, reglarea intensității luminoase, setarea temperaturii de culoare a luminii de la alb cald la alb rece, timer și mod lumină veghe.

IT - Serie di apparecchi per interni equipaggiati con LED SMD, struttura in metallo verniciato bianco opaco, diffusori in acrilico satinato. Le plafoniere sono fornite con telecomando (2 batterie AAA incluse) con molteplici funzioni: ON/OFF, 3 programmi operativi, regolazione dell'intensità della luce, variazione della temperatura del colore da bianco caldo a bianco freddo, timer e modalità luce notturna.

RU - Серия светильников для внутреннего освещения, оснащенных светодиодами SMD, металлическая структура, окрашенная в матовый белый цвет, рассеиватели из сатирированного акрила. Потолочные светильники поставляются с пультом дистанционного управления (2 батарейки AAA входят в комплект) с несколькими функциями: ВКЛ / ВЫКЛ, 3 рабочие программы, регулировка интенсивности света, изменение цветовой температуры от теплого белого до холодного белого, таймер и режим ночного освещения.

HU - Betéri világítotestek, SMD LED-el szerelve, matt fehér fémszerkezet, szatin akril diszperzórral. A mennyezeti változat távirányítóval van ellátva (2db. AAA elem tartozék), a következő funkciókkal: ON/OFF, 3 operációs program, fényerősség, színhőmérséklet, meleg-től hideg-ig, időzítő.

BG - Серия от интериорни осветителни тела с SMD LED платка, метален корпус в бял мат, матов акрилен дифузер. Таванните осветителни тела се доставят с дистанционно (батерии 2 AAA са включени) с различни функции: включване/изключване, 3 оперативни програми, регулиране интензитета на светлината, промяна на цветната температура от топло към студено бяло, таймер и нощен режим.

SK - Sériá interiérových svietidiel vybavených LED diódami SMD, kovová štruktúra lakovaná v matnej bielej farbe, saténové akrylové difúzery. Stropné svietidlá sa dodávajú s diaľkovým ovládaním (2 batérie AAA sú súčasťou dodávky) s viacerými funkciami: ZAP/VYP, 3 operačné programy, regulácia intenzity osvetlenia, kolísanie teploty farby od teplej bielej po studenú bielu, režim časovača a nočné osvetlenie.



01-1762

INFO/DIMENSIONS

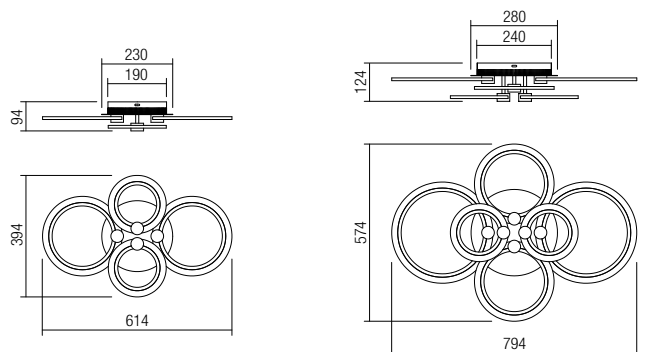
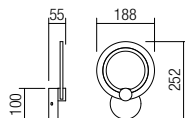

01-1762
SMD LED · 12W
3000/4000/6000K · CRI 85
LED flux 1380 lm
Luminaire flux 924 lm



01-1763
SMD LED · 50W
3000/4000/6000K · CRI 85
LED flux 5480 lm
Luminaire flux 4540 lm



01-1764
SMD LED · 93W
3000/4000/6000K · CRI 85
LED flux 11400 lm
Luminaire flux 7747 lm





01-1763

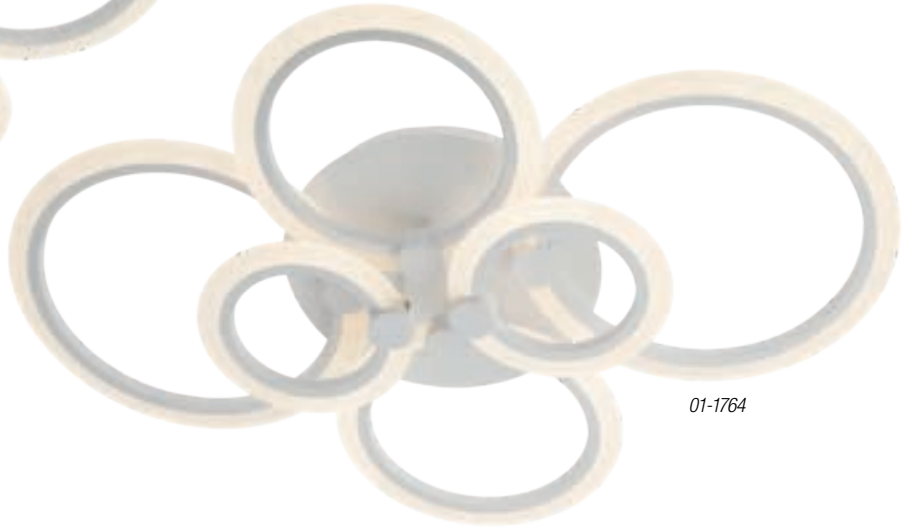

01-1764



01-1764

Petalo



Light fixtures for indoor equipped with SMD LEDs, metal structure painted in mat white, transparent acrylic diffuser with air bubbles effect. The color temperature can be adjusted from warm white to cool white. The ceiling lamps are delivered with remote control (2 AAA batteries included) with multiple functions: ON/OFF, 3 operating programs, light intensity regulation, variation of the color temperature from warm white to cool white, timer and night light mode.

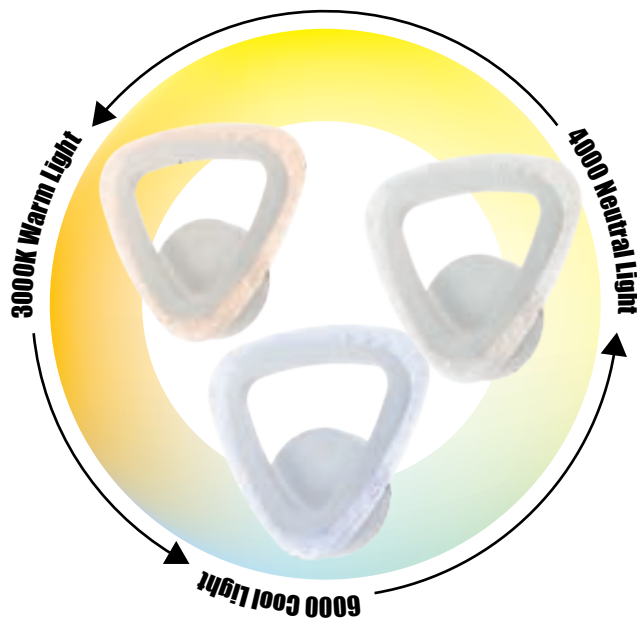

LIGHT COLOR TEMPERATURE CONTROL BY SWITCH

01-2458

RO · Corpuri de iluminat pentru interior echipate cu LED-uri SMD, structură din metal vopsit alb mat, dispersor din acrilic transparent cu efect de bule de aer. Permite setarea temperaturii de culoare a luminii de la alb cald la alb rece. Plafonierele sunt livrate cu telecomandă (cu 2 baterii AAA incluse) cu următoarele funcții: ON/OFF, 3 programe de funcționare, reglarea intensității luminoase, setarea temperaturii de culoare a luminii de la alb cald la alb rece, timer și mod lumină veghe.

IT · Apparecchi per interni equipaggiati con LED SMD, struttura in metallo verniciato bianco opaco, diffusore in acrilico trasparente con effetto bolle. La temperatura del colore della luce può essere regolata dal bianco caldo al bianco freddo. Le plafoniere sono fornite con telecomando (2 batterie AAA incluse) con molteplici funzioni: ON/OFF, 3 programmi operativi, regolazione dell'intensità della luce, variazione della temperatura del colore da bianco caldo a bianco freddo, timer e modalità luce notturna.

RU · Светильники для интерьера, оснащенные светодиодами SMD, металлическая структура, покрашенная в матовый белый, прозрачный акриловый рассеиватель с эффектом воздушных пузырьков. Цветовая температура может быть настроена от теплого белого до холодного белого цвета. Плафоны поставляются с дистанционным управлением (2 батарейки AAA включены в комплект) со следующими функциями: ВКЛ / ВЫКЛ, 3 программы работы, регулирование интенсивности света, настройка цветовой температуры от теплого белого до холодного белого цвета, таймер и дежурная ночная лампочка.

HU · Beltéri lámpa testek, SMD LED-el szerelve, matt fehér fém szerkezet, levegő buborék hatású áttetsző akril diszperzór. Állítható szín hőmérséklet meleg fehérről hideg fehérre. A mennyezeti lámpákhoz távirányító tartozik (2db.AAA elem inkl.). A távirányítónak a következő funkciói vannak: KI/BE kapcsolat, 3 működési beállítás, fényerőszabályzás, színhőmérséklet állítás meleg fehérről hideg fehérre, időzítés és készenléti állapot.

BG · Осветителни тела за интериор, оборудвани със SMD светодиоди, метална структура, боядисана в матово бяло, дифузер от прозрачен акрилен, с ефект на мехурчета. Позволяват задаването на цветната температура на светлината от топло бяло до студено бяло. Таванните осветления се доставят с дистанционно управление (с 2 AAA батерии включени), със следните функции: ON/OFF, 3 работни програми, регулиране на интензитета на светлината, настройка за цветовата температура на светлината от топло бяло до студено бяло, таймер и светлина в режим на готовност.

SK · Interiérové svietidlá vybavené SMD LED diódami, kovová konštrukcia lakovaná matnou bielou farbou, priehľadný akrylový difúzor s efektom vzduchových bublín. Farebnú teplotu je možné nastaviť od teplej bielej po studenú bielu. Stropné lampy sa dodávajú s diaľkovým ovládaním (súčasťou balenia sú 2 batérie AAA) s viacerými funkciami: ZAP./VYP., 3 prevádzkové programy, regulácia intenzity svetla, zmena teploty farieb od teplej bielej po studenú bielu, režim časovača a nočného svetla.



01-2459



REMOTE CONTROL

3 LIGHT PROGRAM
LIGHT COLOR TEMPERATURE CONTROL
 3000/4000/6000K



TIMER

DIMMER

NIGHT LIGHT MODE

01-2460

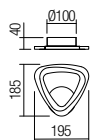
INFO/DIMENSIONS

**01-2458**

SMD LED · 12W
 CCT 3000/4000/6000K (by switch)
 CRI 86
 LED flux 1300 lm
 Luminaire flux 936 lm

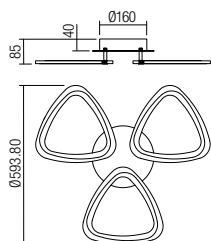
**01-2459**

SMD LED · 53W
 CCT 3000/4000/6000K
 CRI 86
 LED flux 6900 lm
 Luminaire flux 3763 lm

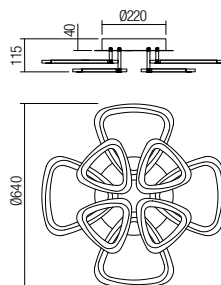
**01-2460**

SMD LED · 120W
 CCT 3000/4000/6000K
 CRI 86
 LED flux 15000 lm
 Luminaire flux 8760 lm

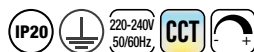



Series of lighting fixtures for indoor equipped with SMD LEDs, structure of aluminium and metal with chrome finish or painted in champagne, opal PVC diffuser.



01-2345



01-2346

RO · Serie de corpuri de iluminat pentru interior echipate cu LED-uri SMD, structură din aluminiu și metal cromat sau vopsită champagne, dispersor din PVC opal.

IT · Apparecchi per interni equipaggiati con LED SMD, struttura in alluminio e metallo cromato oppure verniciata champagne, diffusore in PVC opale.

RU · Серия светильников для внутреннего освещения, оснащенных светодиодами SMD, структура из алюминия и металла с хромированной отделкой или окрашена в цвет "шампань", рассеиватель из опалового ПВХ.

HU · SMD LED-ekkel felszerelt beltéri világítótest-termékcsoport, alumínium és krómozott fém struktúrával vagy champagne színbe festve, opál PVC fényszóróval.

BG · Серия осветителни тела за интериор, оборудвани със SMD светодиоди, структура от алуминий и хромиран метал или боядисана в цвят шампанско, дифузер от опалов PVC.

SK · Sériá svietidiel do interiéru s LED diódami SMD, konštrukcia z hliníka a kovu s chrómovaným povrchom alebo lakovaná vo farbe champagne, opálový difúzor z PVC.

INFO/DIMENSIONS

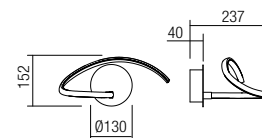
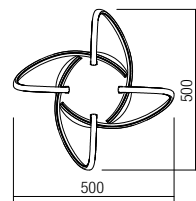
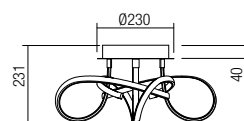

● **01-2345 Chrome**

● **01-2346 Champagne**

SMD LED · 59W · 4000K · CRI 80

LED flux 6290 lm

Luminaire flux 4701 lm



● **01-2343 Chrome**

● **01-2344 Champagne**

SMD LED · 12W · 4000K · CRI 80

LED flux 1450 lm

Luminaire flux 864 lm





01-2344



01-2343



01-2344



01-2343

Mistral



Light fixtures for indoor equipped with SMD LEDs, structure of chromed metal, satin polycarbonate diffusers.

RO · Corpuri de iluminat pentru interior echipate cu LED-uri SMD, structură din metal cromat, dispersoare din policarbonat satinat.

IT · Apparecchi per interni equipaggiati con LED SMD, struttura in metallo cromato, diffusori in policarbonato satinato.

RU · Светильники для внутреннего освещения, оснащенные светодиодами SMD, структура из хромированного металла, рассеиватели из матированного поликарбоната.

HU · Beltéri világítótestek, SMD LED-el ellátva, matt fehér fémszerkezet, szatín polikarbonát diszperzór.

BG · Интериорни осветителни тела с SMD LED платка, метален хромиран корпус, матов дифузер от поликарбонат.

SK · Interiérové svietidlá vybavené LED diódami SMD, štruktúra chrómovaného kovu, saténové polykarbonátové difútory.



01-1939



01-1940

INFO/DIMENSIONS

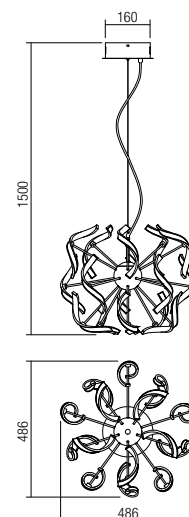
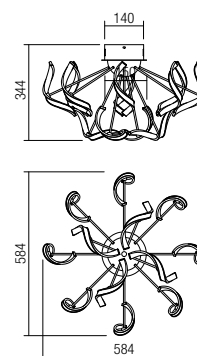

01-1939
SMD LED · 34W
4000K · CRI 82
LED flux 3700 lm
Luminaire flux 2997 lm



01-1940
SMD LED · 38W
4000K · CRI 82
LED flux 4500 lm
Luminaire flux 2861 lm





01-1939

Nunzia



Light fixtures for interior equipped with SMD LEDs, stainless steel and chromed metal body with transparent crystal decorations.

RO · Aparate de iluminat pentru interior echipate cu LED-uri SMD, corp din inox și metal cromat, decorațiuni din cristal transparent.

IT · Apparecchi per interni equipaggiati con LED SMD, corpo in acciaio inox e metallo cromato con decorazioni in cristallo trasparente.

RU · Светильники для интерьера, оснащенные светодиодами SMD, корпус из нержавеющей стали и хромированного металла с прозрачными хрустальными украшениями.

HU · Beltéri lámpatestek, SMD LED-el szerelve, inox és króm fém szerkezet, áttetsző kristály díszekkel.

BG · Осветителни тела за интериор, разполагат със SMD светодиоди, тяло от неръждаема стомана и хромиран метален, прозрачни кристални декорации.

SK · Svetidlá do interiéru vybavené LED diódami SMD, nehrdzavejúcou oceľou a chrómovaným kovovým telom s priehľadnými krištáľovými dekoráciami.



01-2172

INFO/DIMENSIONS

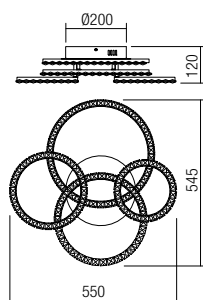
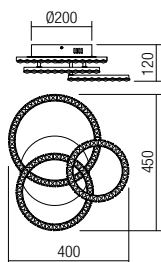

01-2171

SMD LED · 36W · 3000K · CRI 82
LED flux 3410 lm
Luminaire flux 2009 lm



01-2172

SMD LED · 54W · 3000K · CRI 82
LED flux 4833 lm
Luminaire flux 3038 lm



01-2171



01-2173

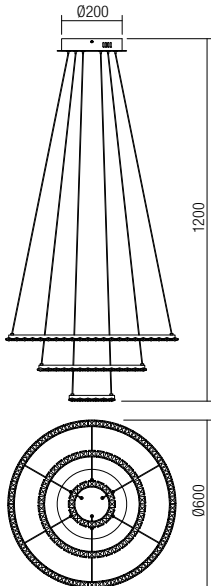

01-2173

SMD LED · 56W · 3000K · CRI 82
 LED flux 5012 lm
 Luminaire flux 3402 lm



Lumo



Light fixtures for indoor equipped with SMD LEDs, metal structure painted in mat white, opal acrylic diffuser.

RO · Corpuri de iluminat pentru interior echipate cu led-uri SMD, structură din metal vopsit alb mat, dispersor din acril opal.

IT · Apparecchi per interni equipaggiati con LED SMD, struttura in metallo verniciato bianco opaco, diffusore in acrilico opale.

RU · Настенные светильники для наружного освещения, оснащенные светодиодами SMD, литой алюминиевый корпус, окрашен в электростатическом поле в матовый белый, темно-серый или темно-коричневый цвет, рассеиватель из опалового поликарбоната.

HU · Kültéri fali lámpák, SMD LED-el szerelve, elektrosztatikus mezőben festett matt fehér, sötét szürke vagy sötét barna nyomás alatt öntött alumínium szerkezet, opál polikarbonát diszperzór.

BG · Осветителни тела за екстериор, оборудвани с SMD светодиоди, корпус от лят под налягане алуминий, боядисан в цвят матово бяло, тъмносиво или тъмнокафяво в электростатично поле, дифузер от опалов поликарбонат.

SK · Nástenné exteriérové svietidlá vybavené LED diódami SMD, hliníková konštrukcia lakoavná v pieskovo-bielej, tmavošedej alebo tmavohnedej, opalový polykarbonátový difúzor.



01-2126

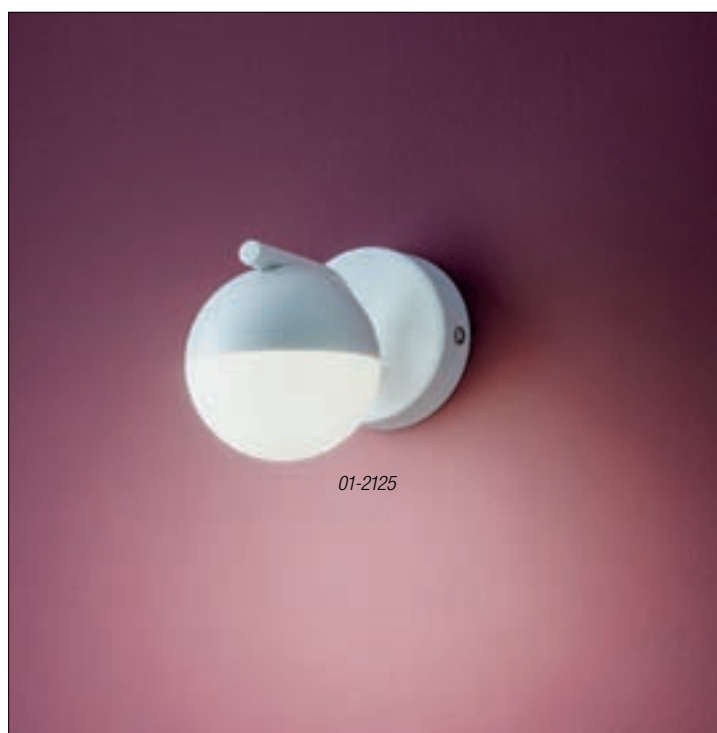

01-2125

INFO/DIMENSIONS



01-2125

SMD LED · 6W · 3000K · CRI 82
LED flux 535 lm
Luminaire flux 433 lm



01-2126

SMD LED · 54W · 3000K · CRI 82
LED flux 6112 lm
Luminaire flux 3726 lm

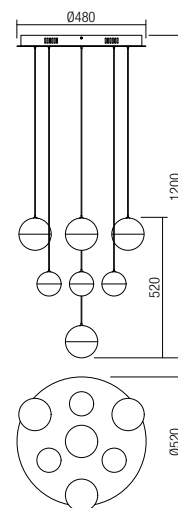



01-2126

Saris



Light fixtures for indoor equipped with SMD LEDs, metal structure painted in white, diffuser with lateral part in resin painted in mat white, mat brown or mat grey and frontal part in opal acrylic.

RO · Serie de corpuri de iluminat pentru interior echipate cu led-uri SMD, structură din metal vopsit alb, dispersor cu parte laterală din rășină vopsită alb mat, maro mat sau gri mat și parte frontală din acril opal.

IT · Serie di apparecchi per interni equipaggiati con LED SMD, struttura in metallo verniciato bianco, diffusore con parte laterale in resina verniciata in bianco opaco, marrone opaco o grigio opaco e parte frontale in acrilico opale.

RU · Светильники для внутреннего освещения, оснащенные светодиодами SMD, металлическая структура, окрашенная в белый цвет, рассеиватель с боковой частью из смолы, окрашенной в матовый белый, матовый коричневый или матовый серый и фронтальной частью из опалового акрила.

HU · Beltéri világítótestek, SMD LED-el ellátva, matt fehér fémszerkezet, a diszperzór oldalsó része matt fehér, barna vagy matt szürke, elől opál akril.

BG · Интериорни осветителни тела с SMD LED платка, метален корпус в бял мат, дифузер със страници от бял мат и централна част от акрил в цвят опал.

SK · Interiérové svietidlá vybavené LED diódami SMD kovová konštrukcia lakovaná v bielej farbe, difúzor s bočnou časťou z živice lakovaný v matnej bielej farbe, matnej hnedej alebo matnej šedej a predná časť v opálovom akryle.



01-1934



01-1933



01-1935

INFO/DIMENSIONS

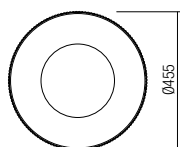
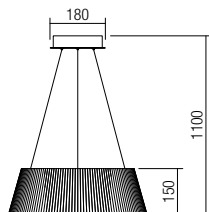
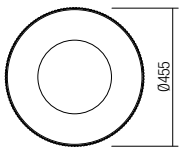
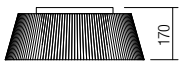

○ 01-1933 Mat White
● 01-1934 Mat Brown

● 01-1935 Mat Grey

SMD LED · 36W · 4000K · CRI 85

LED flux 4832 lm

Luminaire flux 2752 lm



○ 01-1936 Mat White
● 01-1937 Mat Brown

● 01-1938 Mat Grey

SMD LED · 36W · 4000K · CRI 85

LED flux 4832 lm

Luminaire flux 2752 lm

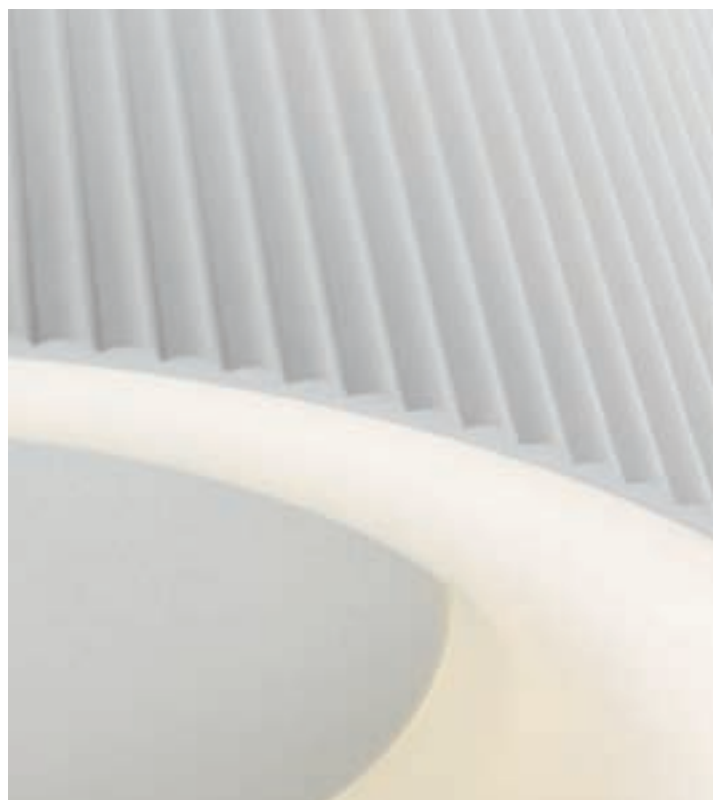



01-1937



01-1938

Gossip

Suspensions for interior, black painted metal structure and metal diffuser finished in white, bronze, copper or black.

RO · Suspensii pentru interior, structură din metal vopsită negru și dispersor din metal finisat alb, bronz, cupru sau negru.

IT · Sospensioni per interni, struttura in metallo verniciato nero e paralume in metallo finitura bianca, bronzo, rame o nera.

RU · Люстры для интерьера, структура из металла окрашенного в черный цвет и рассеиватель из металла белого, черного, медного или бронзового цвета.

HU · Beltéri függesztékek, fekete fémszerkezet, fehér, bronz, réz vagy fekete fém díszperzór.

BG · Висящо интериорно осветително тяло, метална основа, боядисана в черно и метален дифузер със бял, бронзов, меден или черен завършек.

SK · Závesné interiérové svietidlá, čierna lakovaná kovová konštrukcia a kovový difúzor v bielej, bronzovej, medenej alebo čiernej farbe.



INFO/DIMENSIONS

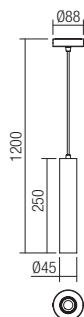

01-1659

01-1660

01-1661

01-1662



- 01-1659 White
- 01-1660 Bronze
- 01-1661 Copper
- 01-1662 Black

E27, 1 x max. 42W





01-1661



Axis



Series of lighting fixtures for interior, structure in aluminum electrostatically painted in mat white/mat black or aluminium anodized in mat gold/mat copper. GU10 bulbs not included.

RO - Serie de corpuri de iluminat pentru interior, structură din aluminiu vopsit în câmp electrostatic alb mat/negru mat sau aluminiu anodizat auriu mat/cupru mat. Becurile GU10 nu sunt incluse.

IT - Serie di apparecchi per interni, struttura in alluminio verniciato a polveri bianco opaco/nero opaco o alluminio anodizzato oro opaco/rame opaco. Lampadine GU10 non incluse.

RU - Серия светильников для интерьера, структура из алюминия, окрашена в электростатическом поле в матовый белый / матовый черный или анодированна в матовое золото / матовую медь. Лампы GU10 не включены в комплект.



01-2148



01-2146



01-2155



01-2153



01-2162

INFO/DIMENSIONS

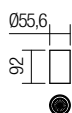

- 01-2147 Mat White
- 01-2148 Mat Black
- 01-2149 Mat Gold
- 01-2150 Mat Copper

GU10, 1 x max. 35W



- 01-2143 Mat White
- 01-2144 Mat Black
- 01-2145 Mat Gold
- 01-2146 Mat Copper

GU10, 1 x max. 35W

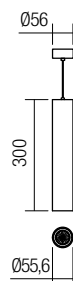

- 01-2151 Mat White
- 01-2152 Mat Black
- 01-2153 Mat Gold
- 01-2154 Mat Copper

GU10, 1 x max. 35W



- 01-2155 Mat White
- 01-2156 Mat Black
- 01-2157 Mat Gold
- 01-2158 Mat Copper

GU10, 1 x max. 35W

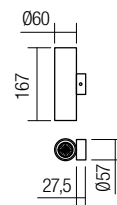

- 01-2159 Mat White
- 01-2160 Mat Black
- 01-2161 Mat Gold
- 01-2162 Mat Copper

GU10, 2 x max. 35W



HU - Beltéri lámpatestek, elektrosztatikus mezőben matt fehér/
matt feketére festett alumínium szerkezet vagy matt arany/matt
réz alumínium szerkezet.
GU10-es izzó nem tartozék.

BG - Серия осветителни тела за интериор, структура от
алуминий боядисана в електростатично поле в цвят матово
бяло/матово черно или анодизиран алуминий в цвят матово
злато/матов мед.
Крушките GU10 не са включени.

SK - Sériá svietidiel pre interiér, konštrukcia z hliníka
elektrostaticky lakovaná matnou bielou / matnou čiernou alebo
eľoxovaná hliníkom z matného zlata / matnej medi.
Žiarovky GU10 nie sú súčasťou balenia.





Ceiling lamps for interior, structure of metal painted in sand gold, sand black or finished in corten.

RO · Plafoniere pentru interior, structură din metal vopsit auriu mat, negru mat sau finisat corten.

IT · Plafoniere per interni, struttura in metallo verniciato oro, nero o con finitura corten.

RU · Потолочные светильники для интерьера, каркас из металла, окрашенного в песочно-золотой, песочно-черный цвет или отделанный кортенем.

HU · Beltéri mennyezeti, matt arany, matt fekete vagy barna fémszerkezet.

BG · Таванни осветления за интериор, метална основа боядисана в черно злато, матово черно или кортен.

SK · Séria svietidiel pre interiér, štruktúra kovu lakovaná v pieskovej zlatej, matnej čiernej alebo corten farbe.



01-2409



01-2410



01-2411



INFO/DIMENSIONS

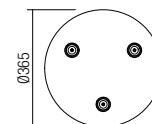
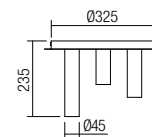
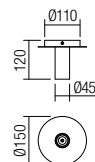

01-2409 Gold
01-2410 Rust
01-2411 Black

E27, 1 x max. 42W



01-2412 Gold
01-2413 Rust
01-2414 Black

E27, 3 x max. 42W





01-2414

Kato



Series of adjustable ceiling lamps for interior, aluminum structure electrostatically painted in mat white or mat black, front part in silver color.

RO · Serie de plafoniere orientabile pentru interior, structură din aluminiu vopsit în câmp electrostatic în versiuni de culoare alb mat sau negru mat, cu parte frontală vopsită argintiu.

IT · Serie di plafoniere orientabili per interni, struttura in alluminio verniciato a polveri bianco opaco o nero opaco, parte frontale in argento.

RU · Серия ориентируемых потолочных светильников для интерьера, алюминиевая конструкция, окрашенная в электростатическом поле в матовый белый или матовый черный цвет, передняя часть серебристого цвета.

HU · Beltéri mozgatható mennyezeti lámpák, elektrosztatikus mezőben festett alumínium szerkezet, matt fehér vagy matt fekete színben, oldalt ezüst.

BG · Серия интериорни регулируеми плафониери, структура от алуминий електростатично боядисани в матово бяло или матово черно, предна част в сребрист цвят.

SK · Sériá nastaviteľných, interiérových stropných svietidiel, hliníková konštrukcia lakovaná v matnej bielej alebo matnej čiernej farbe, predná časť strieborná.



01-1306

01-1307



INFO/DIMENSIONS

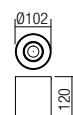

○ 01-1306 Mat White
● 01-1307 Mat Black

GU10, 1 x max. 35W



Koa



Ceilings lamp for interior, aluminium structure electrostatically painted in mat white or mat black.

Versions with mat gold decorative inner ring available for both finishes. GU10 bulbs not included.

RO - Plafoniere pentru interior, structură din aluminiu vopsit în câmp electrostatic alb mat sau negru mat. Versiuni cu inel decorativ vopsit auriu mat disponibile pentru ambele finisaje. Becurile GU10 nu sunt incluse.

IT - Plafoniere per interni, struttura in alluminio verniciato a polveri bianco opaco o nero opaco. Versioni con anello decorativo verniciato oro opaco disponibile per entrambe le finiture. Lampadina GU10 non inclusa.

RU - Потолочные люстры для интерьера, структура из алюминия окрашеного в электростатическом поле в белый матовый или черный матовый цвет. Варианты с декоративным кольцом окрашенным под матовое золото доступны для обоих цветов. Лампы GU10 не входят в комплект.

HU - Beltéri mennyezeti lámpák, elektrosztatikus mezőben matt fehérre vagy matt feketére festett alumínium szerkezet, arany színű díszítő gyűrűvel. GU10 izzó nem tartozék.

BG - Тавани осветления за интериор, алуминиева структура боядисани в матово бяло или матово черно в электростатично поле. Версии с декоративен пръстен боядисан в матово злато, предлагани и за двата цвята. Крушите GU10 не са включени.

SK - Stropné interiérové svetidlá, hliníková konštrukcia lakovaná v matnej bielej, alebo matnej čiernej farbe. Verzie s matným zlatom s ozdobným vnútorným prsteňom k dispozícii pre obe povrchové úpravy. Žiarovky GU10 nie sú súčasťou balenia.



01-2163

01-2164

01-2165

01-2166

INFO/DIMENSIONS

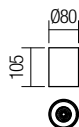

○ ○ 01-2163 Mat White+Mat White Inner Ring

○ ● 01-2164 Mat White+Mat Gold Inner Ring

● ● 01-2165 Mat Black+Mat Black Inner Ring

● ● 01-2166 Mat Black+Mat Gold Inner Ring

GU10, 1 x max. 35W



Peep



Series of interior light fittings, metal structure and diffuser electrostatically painted in mat white or mat black.

RO · Serie de corpuri de iluminat pentru interior, structură și dispersor din metal vopsit în câmp electrostatic în versiuni de culoare alb mat sau negru mat.

IT · Serie di apparecchi per interni, struttura e paralume in metallo verniciato a polveri bianco opaco o nero opaco.

RU · Серия подвесных люстр для интерьера, металлическая конструкция и рассеиватель, окрашены в электростатическом поле в матовый белый или матовый черный цвет.

HU · Beltéri világítótestek, elektrosztatikus mezőben festett fémszerkezet és diszperzór, matt fehér vagy matt fekete színben.

BG · Серия интериорни осветителни тела, структура и разсейвател от метал електростатично боядисани в матово бяло, матово сиво или матово черно.

SK · Sériá interiérových svietidiel, kovová konštrukcia a difúzor lakovaná v matnej bielej alebo matnej čiernej farbe.



01-1281



01-1279



01-1280

INFO/DIMENSIONS

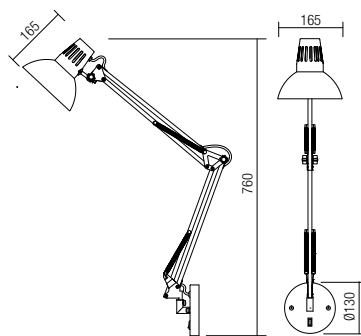

● 01-1278 Mat Black

E27, 1 x max. 42W

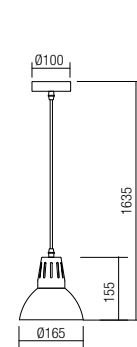

● 01-1279 Mat Black

E27, 1 x max. 42W

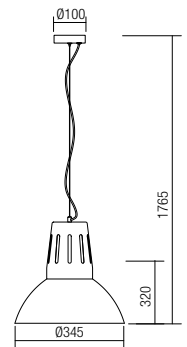

● 01-1281 Mat Black

E27, 1 x max. 42W





01-1284

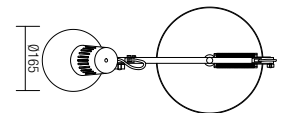
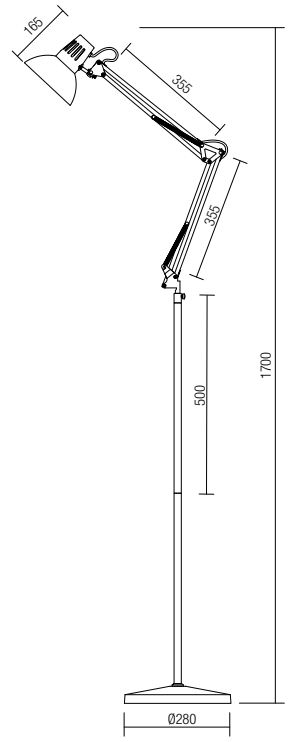

● 01-1284 Mat Black

E27, 1 x max. 42W



01-1278



01-1283

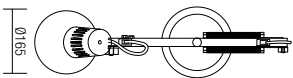
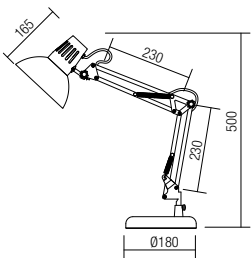

● 01-1283 Mat Black

E27, 1 x max. 42W



Kimono



Series of suspensions for interior, metal structure and shade electrostatically painted available in mat white, mat gold, mat copper or mat black with copper or black detail.

RO - Serie de suspensii pentru interior, structură și dispersor din metal vopsit în câmp electrostatic, disponibilă în versiuni de culoare alb mat, aur mat, cupru mat sau negru mat cu detalii vopsit cupru sau negru.

IT - Serie di sospensioni per interni, struttura e paralume in metallo verniciato a polveri disponibile nelle variante colori bianco opaco, oro opaco, rame opaco o nero opaco con dettaglio ramato o nero opaco.

RU - Серия люстр для интерьера, структура и рассеиватель из металла окрашенного в электростатическом поле, доступны в вариантах цветов: белый матовый, золотой матовый, медный матовый или черный матовый с деталями окрашенными в медный или черный цвета.

HU - Beltéri világítótések elektrosztatikus mezőben festett matt fehér, matt réz, matt arany vagy matt fekete fémszerkezet réz betéttel vagy feketével.

BG - Серия окачвания за интериор, метална конструкция и нюанс, боядисани с электростатично покритие, предлагани в матово бяло, матово злато, мат мед или матово черно с медни или черни детайли.

SK - Sériá interierových závesných svietidiel, kovová konštrukcia a tienidlá lakované vo farbách matná biela, matná zlatá, matná medená alebo matná čierna s medenými alebo čiernymi detailami.



01-1462



INFO/DIMENSIONS

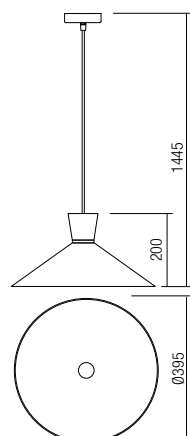

- 01-1459 Mat White
- 01-1460 Mat Gold
- 01-1461 Mat Copper
- 01-1462 Mat Black

E27, 1 x max. 42W



01-1460





Series of suspensions for interior, structure and shade in metal electrostatically painted in glossy white/glossy black in exterior and mat white in interior or in metal finished in lacquered brass/lacquered copper, black fabric wire.

RO · Serie de suspensii pentru interior, structură și dispersor din metal vopsit în câmp electrostatic în versiuni alb lucios/negru lucios la exterior și alb mat la interior sau din metal cu finisaj alamă lăcuită/cupru lăcuit, cablu textil negru.

IT · Sospensioni per interni, struttura e paralume in metallo verniciato a polveri bianco lucido/nero lucido al esterno e bianco opaco al interno o in metallo finitura ottone laccato/rame laccato, cavo tessile nero.

RU · Серия люстр для интерьера, структура и рассеиватель из металла окрашенного в электростатическом поле в вариантах белый/черный глянцевый снаружи и белый матовый внутри или из металла отделанного под лакированную латунь/медь, кабель в черном текстиле.

HU · Beltéri világítótестek, elektrosztatikus mezőben festett kívül fényes fehér/fényes fekete, belül matt fehér vagy lakkozott sárgaréz/lakkozott réz fémszerkezet és diszperzór, fekete textil kábellel.

BG · Серия от окачвания за интериор, конструкция и нюанс в метал, излъскани в лъскаво бяло/лъскаво черно в екстериора и матово бели в интериора или в метал, изработени от лакиран месинг/лакирана мед, черен текстилен кабел.

SK · Sériá interiérových závesných svetidiel, kovová konštrukcia a tienidlá lakované v lesklej bielej/lesklej čiernej farbe zvonka a matnej bielej zvnútra alebo v kovovom prevedení s lakovanou mosadzou/lakovanou medenou, čierny tkaninový kábel.



01-1456

01-1458

INFO/DIMENSIONS

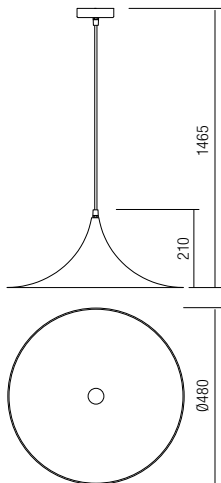

- 01-1455 White
- 01-1456 Brass
- 01-1457 Copper
- 01-1458 Black

E27, 1 x max. 42W



01-1457



White



Brass

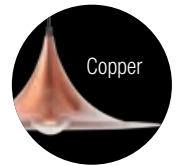

Copper



Black

Galileo



Suspension for interior, metal structure and diffuser electrostatically painted in mat black, red textile cable.

RO · Suspensie pentru interior, structură și dispersor din metal vopsit în câmp electrostatic negru mat, cablu textil roșu.

IT · Sospensione per interni, struttura e diffusore in metallo verniciato a polveri nero opaco, cavo tessile rosso.

RU · Люстра для интерьера, металлическая структура и рассеиватель окрашены в электростатическом поле в черный матовый цвет, кабель из красного текстиля.

HU · Beltéri függeszték, elektrosztatikus mezőben matt feketére festett fém szerkezet, piros textil kábel.

BG · Окачване за интериор, структура и дифузер от метал боядисана в электростатично поле в матово черно, червен текстилен кабел.

SK · Závesné svietidlá pre interiér, kovová štruktúra a difúzor elektrostaticky lakované matnou čiernou a s červeným textilným káblom.



INFO/DIMENSIONS



01-2174

E27, 1 x max. 42W

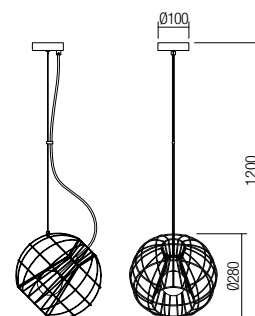



01-2174



Sketch



Series of interior light fittings, metal structure electrostatically painted in black with copper plated metal elements.

RO · Serie de corpuri de iluminat pentru interior, structură din metal vopsit în câmp electrostatic negru cu elemente metalice finisaj cupru.

IT · Serie di apparecchi per interni, struttura in metallo verniciato a polveri nero con particolari in metallo finitura rame.

RU · Серия светильников для интерьера, металлическая структура окрашена в электростатическом поле в черный цвет, с металлическими элементами отделанными медью.

HU · Beltéri világítótestek, elektrosztatikus mezőben festett fekete fémszerkezet réz betéttel.

BG · Серия интериорни осветителни тела, структура от метал електростатично боядисана в черно с метални елементи с медно покритие.

SK · Sériá interiérových svietidiel, kovová konštrukcia lakovaná v čiernej farbe s medenými prvkami.



01-1261

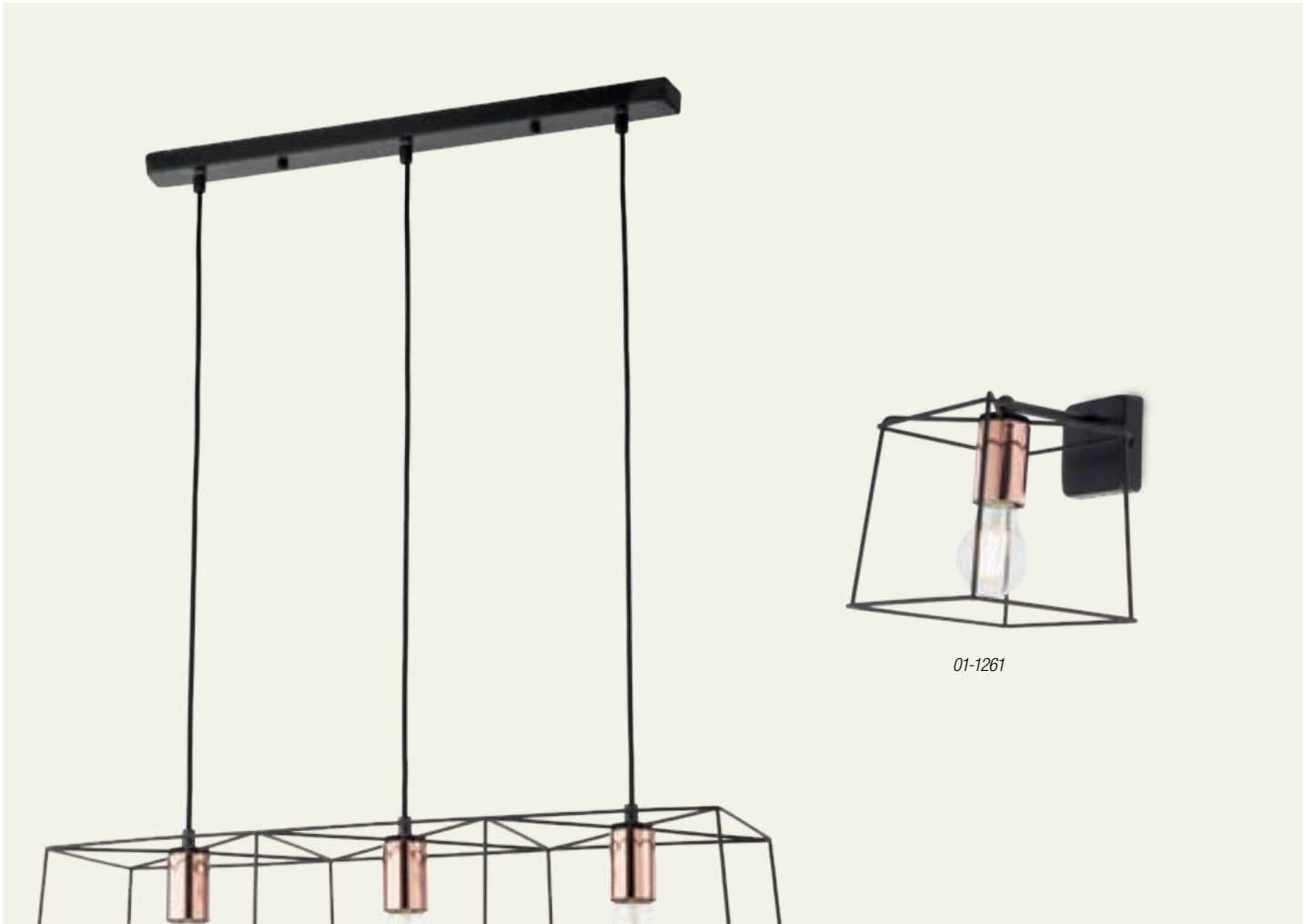

01-1261

01-1266

INFO/DIMENSIONS

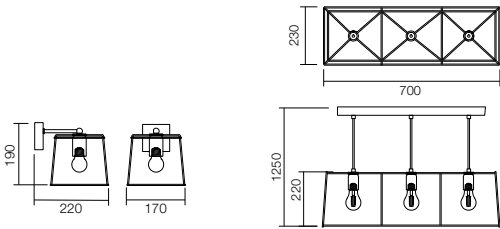

01-1261
E27, 1 x max. 42W
IP20 230V 50Hz

01-1266
E27, 3 x max. 42W
IP20 230V 50Hz



01-1265

Sketch

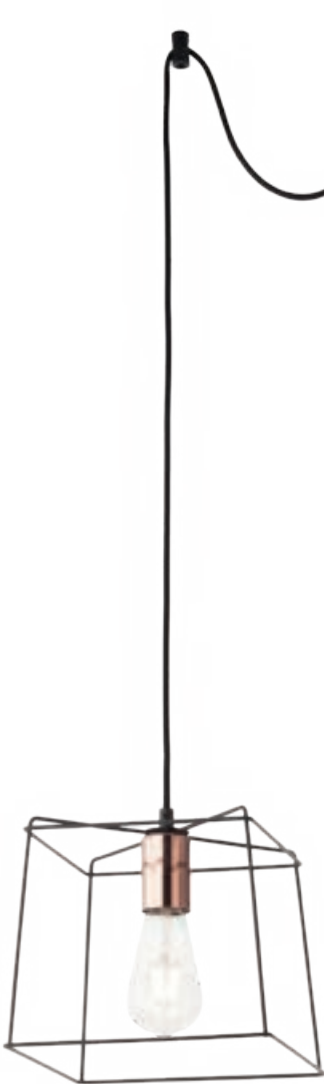

01-1264

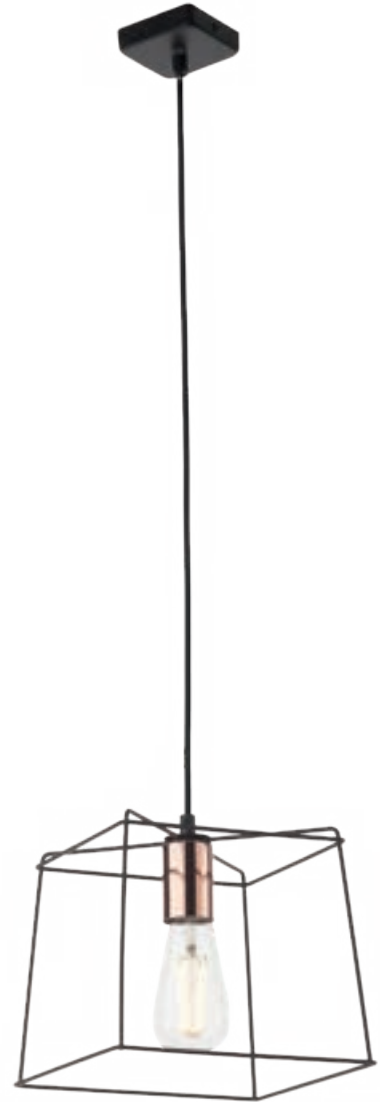

01-1262

INFO/DIMENSIONS

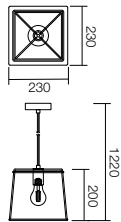

01-1262

E27, 1 x max. 42W

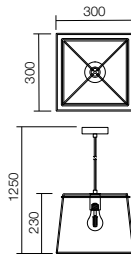

01-1263

E27, 1 x max. 42W

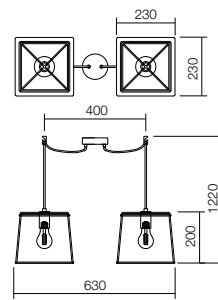

01-1264

E27, 2 x max. 42W

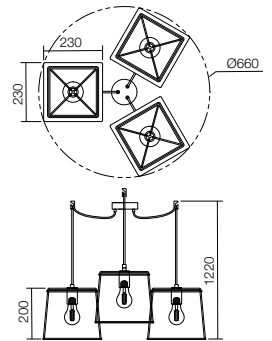

01-1265

E27, 3 x max. 42W



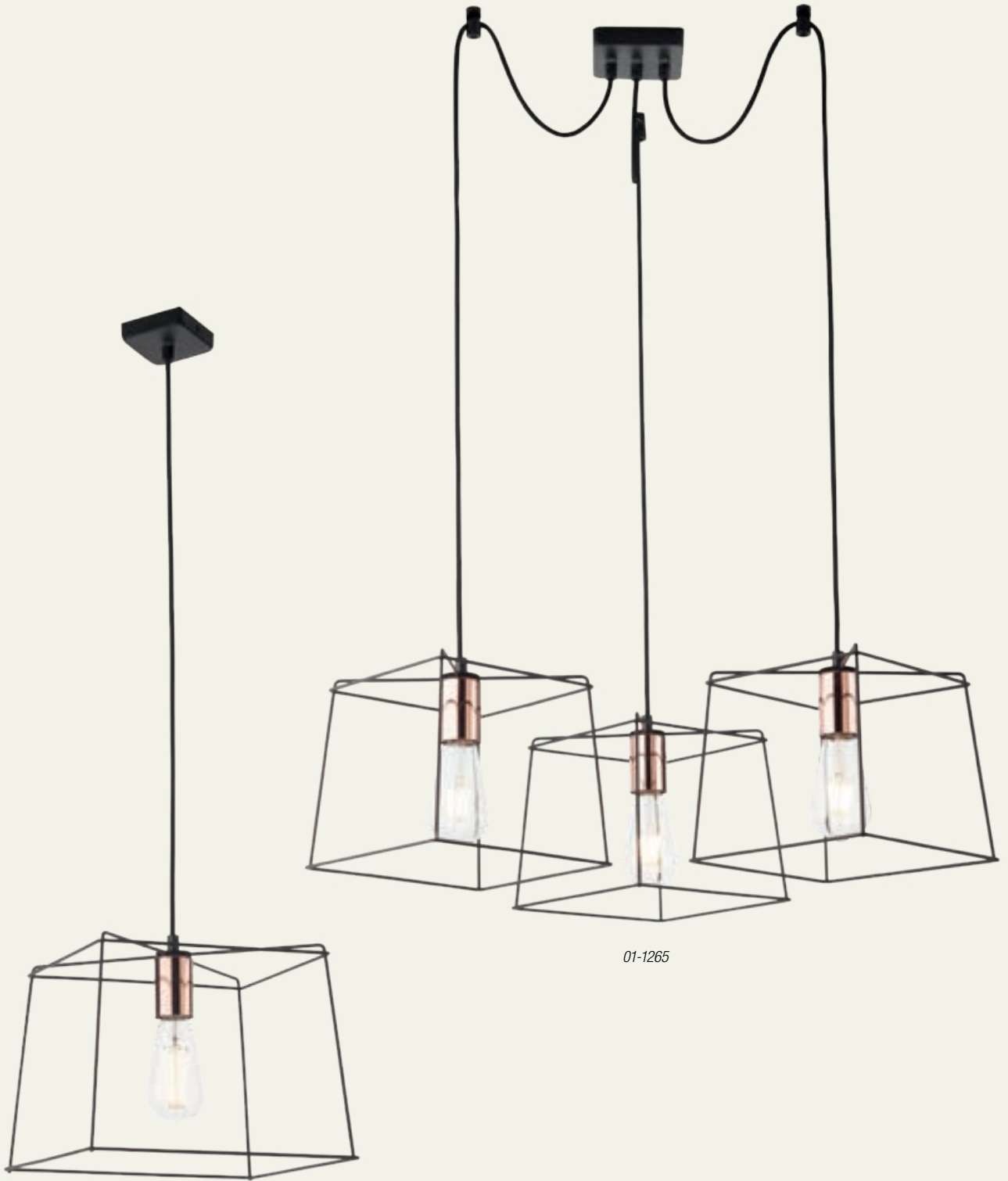

01-1263

01-1265

Yak



Series of lamps for interior, metal structure painted in mat black with gold details.

RO - Serie de corpuri pentru interior, structură din metal vopsit negru mat cu detalii finisate aur.

IT - Serie di apparecchi per interni, struttura in metallo verniciato nero opaco con dettagli finitura oro.

RU - Серия светильников для интерьера, структура из металла окрашенного в черный матовый цвет с золотистыми элементами.

HU - Beltéri lámpatestek, matt fekete fémszerkezet arany díszítéssel.

BG - Серия от интериорни лампи, метална основа, боядисана в черен мат със златни детайли.

SK - Sériá interiérových svietidiel, kovová konštrukcia lakovaná v matnej čiernej farbe so zlatými detailmi.



01-1669



01-1668



01-1667

INFO/DIMENSIONS

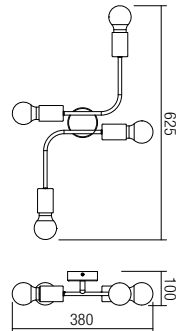
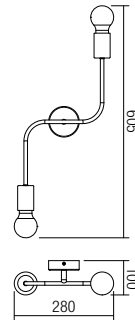
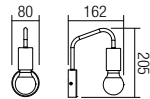

01-1667

E27, 1 x max. 42W



01-1668

E27, 2 x max. 42W



01-1669

E27, 4 x max. 42W





01-1667



Spider

Series of interior light fittings, metal structure electrostatically painted in mat black with antique copper details.

RO · Serie de corpuri de iluminat pentru interior, structură din metal vopsit în câmp electrostatic negru mat cu detalii finisate cupru antichizat.

IT · Serie di apparecchi per interni, struttura in metallo verniciato a polveri nero opaco, dettagli finitura rame anticato.

RU · Серия светильников для интерьера, металлическая структура, окрашена в электростатическом поле в матовый черный цвет с элементами из состаренной меди.

HU · Beltéri világítótestek, elektrosztatikus mezőben festett matt fekete fémszerkezet antikolt réz betéttel.

BG · Серия интериорни осветителни тела, структура от метал електростатично боядисана в матово черно с антично медни детайли.

SK · Sériá interiérových svietidiel, kovová konštrukcia lakovaná v matnej čiernej farbe so starožitnými medenými detailami.



01-1258



01-1259



01-1260

INFO/DIMENSIONS

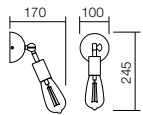

01-1258

E27, 1 x max. 42W

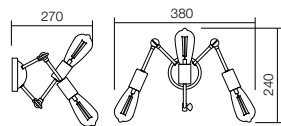

01-1259

E27, 3 x max. 42W

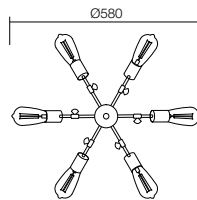

01-1260

E27, 6 x max. 42W

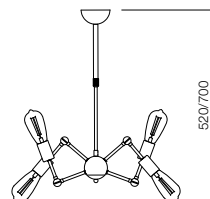

Qipao

Series of suspensions for interior, metal structure electrostatically painted in black, diffuser of transparent glass and copper plated fretted metal.

RO · Serii de suspensii pentru interior, structură din metal vopsit în câmp electrostatic negru, dispersor din sticlă transparentă și metal cuprat traforat.

IT · Serie di sospensioni per interni, struttura in metallo verniciato a polveri nero, diffusore in vetro trasparente e metallo ramato traforato.

RU · Серия подвесных люстр для интерьера, металлическая структура, окрашенная в электростатическом поле в черный цвет, рассеиватель из прозрачного стекла и металла покрытого медью.

HU · Beltéri függeszték, elektrosztatikus mezőben festett fekete fémszerkezet, áttetsző üveg búra réz színű fém betéttel.

BG · Серия интериорни полилеи, структура от метал електростатично боядисана в черно, разсейвател от прозрачно стъкло и прояден метал с медно покритие.

SK · Sériá interiérových závesných svietidiel, kovová konštrukcia lakovaná v čiernej farbe, difúzor z priehľadného skla a medeného kovu.



01-1256

01-1255



01-1257

INFO/DIMENSIONS

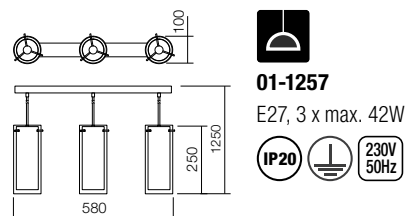
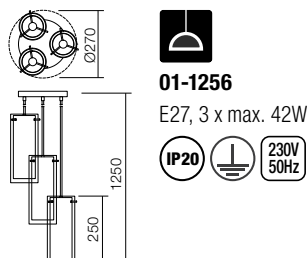
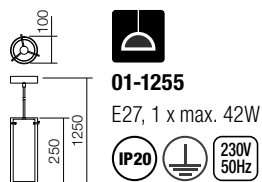



01-1255

Formi



Suspensions for interior, metal struture painted in mat black with chromed details, fretted metal diffuser with mat black finish.

RO · Suspensii pentru interior, structură din metal vopsit negru cu detalii cromate, dispersor din metal traforat vopsit negru mat.

IT · Sospensioni per interni, struttura in metallo verniciata nero opaco con dettagli cromati, diffusore in metallo traforato finitura nero opaco.

RU · Люстры для интерьера, металлическая структура окрашенная в черный цвет с хромированными деталями, металлический перфорированный рассеиватель с матовой черной отделкой.

HU · Beltéri függesztékek, fekete króm betétű fém szerkezet, matt fekete perforált fém diszperzór.

BG · Окачвания за интериор, метална структура боядисана в черно, с хромирани детайли, дифузер от перфорирани метал боядисан в матово черно.

SK · Závěsné svietidlá do interiéru, kovová konštrukcia lakovaná matnou čiernou farbou s chrómovanými detailmi, kovové tienidlo s matnou čiernou povrchovou úpravou.

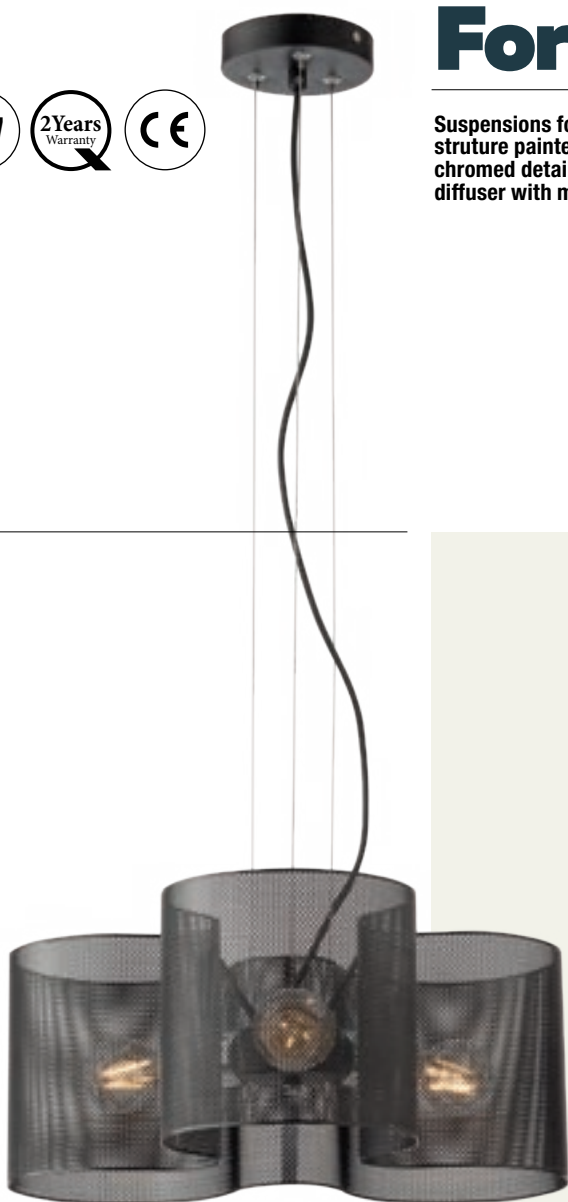

01-1990

INFO/DIMENSIONS

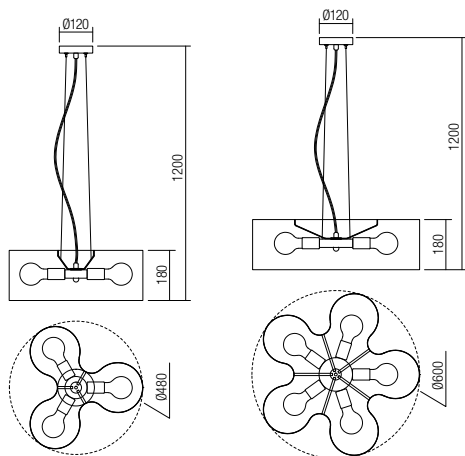

01-1990

E27, 3 x max. 42W



01-1991

E27, 5 x max. 42W



01-1991



01-1991

Proteus



Suspensions for interior, metal structure and fretted metal diffuser with mat gold finish, black textile cable.

RO · Suspensii pentru interior, structură din metal cu dispersor din metal traforat finisaj aur mat, cablu textil negru.

IT · Sospensioni per interni, struttura metallica e diffusore in metallo traforato finitura oro opaco, cavo tessile nero.

RU · Люстры для интерьера, металлическая структура с рассеивателем из тесненного металла отделаны под матовое золото, кабель в черном текстиле.

HU · Beltéri függesztekek, matt arany színű fémszerkezet, fekete textil kábel.

BG · Висящи интериорни осветителни тяла, метална структура и наъбен метален дифузер с покритие от златен мат и черен текстилен кабел.

SK · Závesné interiérové svietidlá, kovové konštrukcie a kovový difúzer s matným zlatým povrchom, čierny tkaninový kábel.



INFO/DIMENSIONS

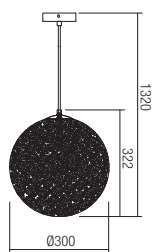

01-1513

E27, 1 x max. 42W

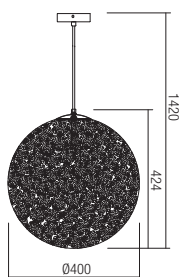

01-1514

E27, 1 x max. 42W





01-1514



Indua



Lighting fixtures for interior, metal structure and fretted metal diffusers with mat gold finish.

RO · Corpuri de iluminat pentru interior, structură din metal cu dispersoare din metal traforat finisaj aur mat.

IT · Apparecchi per interni, struttura metallica e diffusori in metallo traforato finitura oro opaco.

RU · Светильники для интерьера, металлическая структура и металлические перфорированные рассеиватели с отделкой под золото.

HU · Beltéri lámpatestek, matt arany fémszerkezet és perforált fém diszperzór.

BG · Осветителни тела за интериор, метална структура с дифузери от перфориран метал, цвят матово златно.

SK · Svetidlá pre interiér, kovová konštrukciu a kovové difúzory s matnou zlatou povrchovou úpravou.



01-2192



01-2192

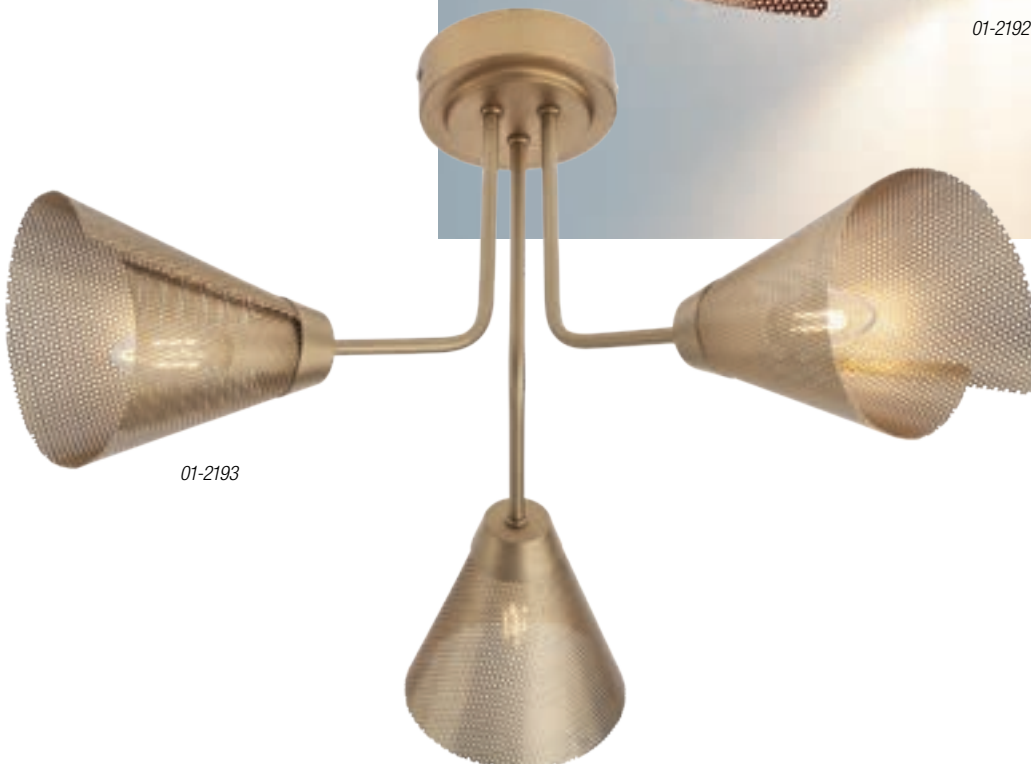

01-2193



01-2195

01-2194

INFO/DIMENSIONS

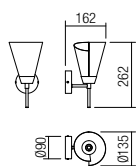

01-2192

E27, 1 x max. 42W

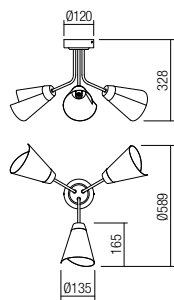

01-2193

E27, 3 x max. 42W

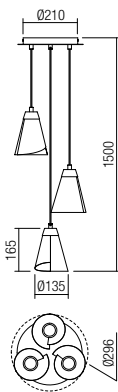

01-2194

E27, 3 x max. 42W

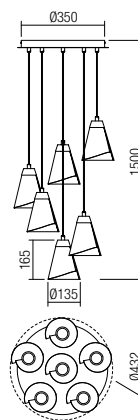

01-2195

E27, 6 x max. 42W



Vanilla



Series of interior light fittings, black finish metal structure, metal lampshade covered in decorative PVC material.

RO · Serie de corpuri de iluminat pentru interior, structură din metal vopsit negru, abajur din metal îmbrăcat în material PVC decorativ.

IT · Serie di apparecchi per interni, struttura in metallo verniciato nero, paralume in metallo rivestito in PVC decorativo.

RU · Серия светильников для интерьера, со структурой из металла окрашенного в черный цвет, абажур из металла покрытого декоративным ПВХ материалом.

HU · Beltéri világítótestek, fekete fémszerkezet és fém ernyővel.

BG · Серия интериорни осветителни тела, структура от метал, боядисан в черно, абажур от метал, облечен в декоративен ПВХ материал.

SK · Sériá interiérových svietidiel, kovová štruktúra v čiernej farbe, kovové tienidlo dekorované PVC materiálom.



01-1171

01-1172

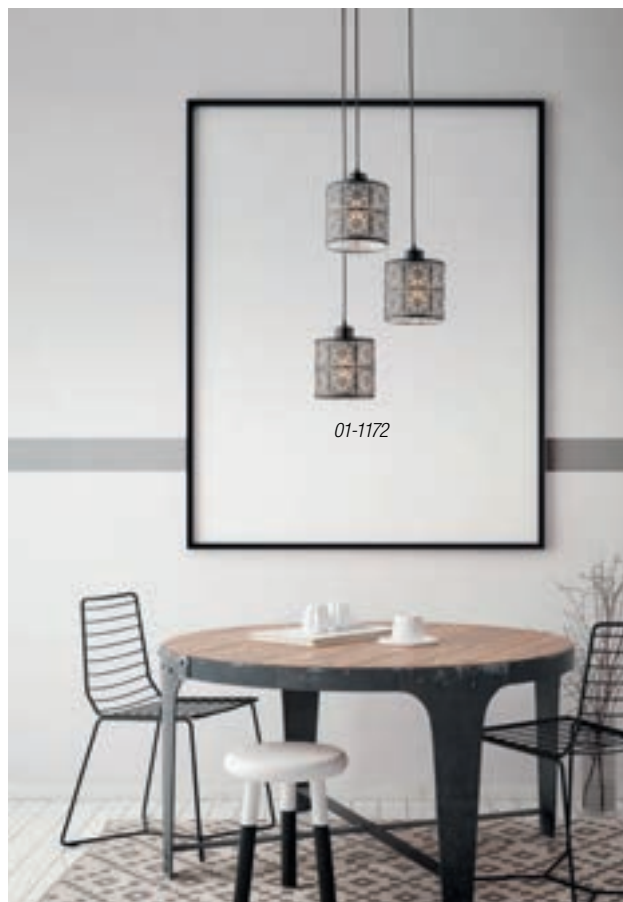

01-1172

INFO/DIMENSIONS



01-1170

E27, 1 x max. 42W

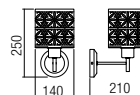

01-1171

E27, 1 x max. 42W



01-1172

E27, 3 x max. 42W

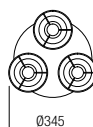
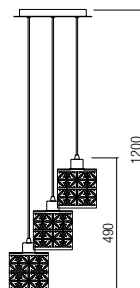



01-1170

Tamis



Series of lamps for interior, metal structure painted in mat black with satin gold metallic details, diffusers in metal with tracers painted in mat black.

RO · Serie de lămpi pentru interior, structură din metal vopsit negru mat cu detalii finisate aur satinat, dispersoare din rețea metalică vopsite negru mat.

IT · Serie di apparecchi per interni, struttura in metallo verniciato nero opaco con dettagli in metallo finitura oro satinato, diffusori in rete metallica verniciati nero opaco.

RU · Серия светильников для интерьера, структура из металла окрашенного в черный матовый цвет с элементами отделки под матовое золото, рассеиватели из металлической сетки черного цвета.

HU · Beltéri lámpatestek, fekete színű fémszerkezet, matt arany diszitéssel, matt fekete diszperzorra.

BG · Серия от интериорни лампи, метална структура, боядисана в черен мат, със златни метални детайли, дифузер от метал с декорации, боядисани в черен мат.

SK · Sériá svietidiel pre interiér, kovová konštrukcia maľovaná v matnej čiernej farbe so zlatými kovovými detailmi zo saténu, difúzory v kovovej farbe so stopami potiahnutými v matnej čiernej farbe.



01-1572



01-1572

INFO/DIMENSIONS

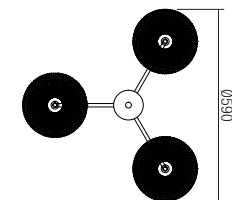
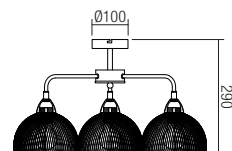
**01-1570**

E27, 3 x max. 42W

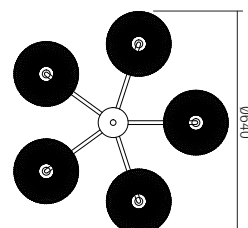
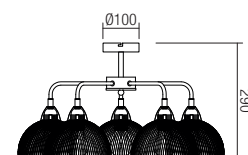
**01-1571**

E27, 5 x max. 42W

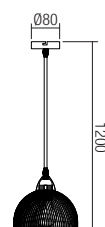
**01-1572**

E27, 1 x max. 42W



01-1570



01-1571

Tamis



01-1574

01-1573



01-1569



01-1569

INFO/DIMENSIONS

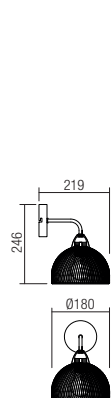

01-1569
E27, 1 x max. 42W
IP20 230V 50Hz

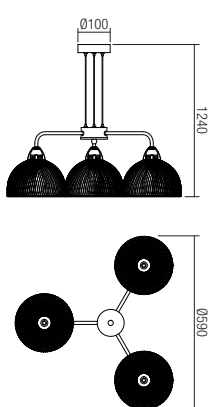

01-1573
E27, 3 x max. 42W
IP20 230V 50Hz

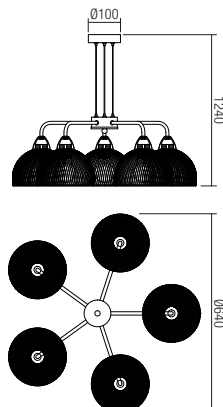

01-1574
E27, 5 x max. 42W
IP20 230V 50Hz

Edison



Series of lamps for interior, metal structure painted in black with antique copper metallic details, copper plated metal diffusers with tracers.

RO · Serie de lămpi pentru interior, structură din metal vopsit negru cu detalii finisate cupru antichizat, dispersoare din rețea metalică cuprată.

IT · Serie di lampade per interni, struttura in metallo verniciato nero con dettaglio in metallo finitura rame anticato, diffusori in rete metallica ramata.

RU · Серия светильников для интерьера, структура из металла окрашенного в электростатическом поле в черный матовый цвет с декором под старую медь, рассеиватели из омедненной металлической сетки.

HU · Beltéri lámpatestek, fekete fémszerkezet antik réz mintázattal, réz fémhálós diszperzór.

BG · Серия от интериорни лампи, метална структура, боядисана в черно със състарени медни детайли, декорации с медно покритие на дифузера.

SK · Séria interiárových svietidiel, kovové konštrukcie maľované v čiernom prevedení so starožitnými kovovými detailmi, medené kovové difúzory.



01-1576



01-1575



01-1577



01-1577

INFO/DIMENSIONS

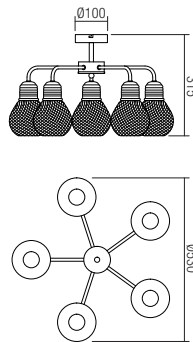
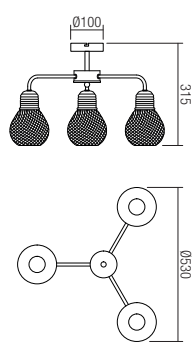
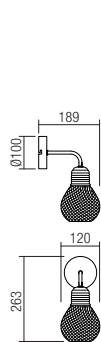

01-1575

E27, 1 x max. 42W



01-1576

E27, 3 x max. 42W



01-1577

E27, 5 x max. 42W



Edison



01-1578



01-1579



01-1580



INFO/DIMENSIONS

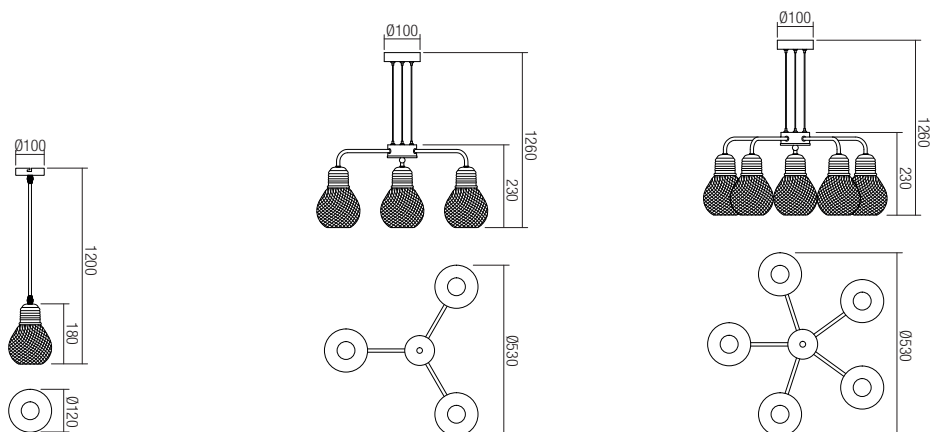

01-1578

E27, 1 x max. 42W



01-1579

E27, 3 x max. 42W



01-1580

E27, 5 x max. 42W





Suspensions for interior, satin gold metal structure, blown opal glass diffuser.

RO · Suspensii pentru interior, structură din metal finisat auriu mat cu dispersor din sticlă suflată opal.

IT · Sospensioni per interni, struttura in metallo finitura oro opaco, diffusore in vetro soffiato opale.

RU · Навесные светильники для интерьера, структура металлическая сатинового золотистого цвета, стеклянный рассеиватель с опаловым напылением.

HU · Beltéri függesztékek, matt arany fém szerkezet, fújt opál üveg.

BG · Окачвания за интериор, матова златна метална структура с дифузьор от издувано опалово стъкло.

SK · Interiérové závesné svietidlá, kovová konštrukcia v saténovej zlatej, difúzor z fúkaného opálového skla.



01-2623



01-2624



01-2625



01-2626



01-2627

INFO/DIMENSIONS

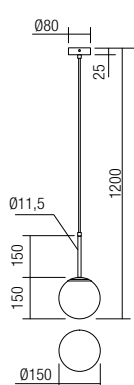

01-2623

E14, 1 x max. 28W

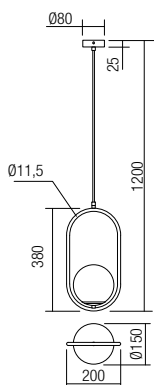

01-2624

E14, 1 x max. 28W

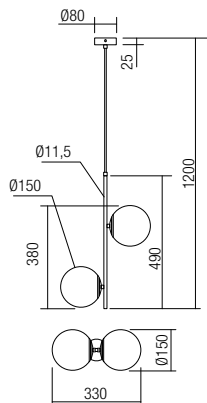

01-2625

E14, 2 x max. 28W

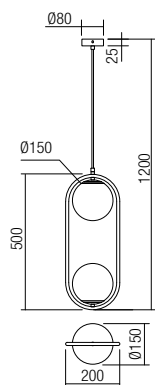

01-2626

E14, 2 x max. 28W

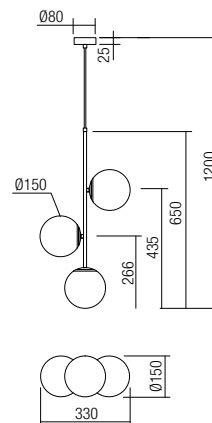

01-2627

E14, 3 x max. 28W





01-2627



Nido

Series of suspensions for interior, black PMMA structure, blown glass diffuser tinted amber, blue, red or smoke.

RO · Serie de suspensii pentru interior, structură din PMMA negru, dispersor din sticlă suflată ambra, bleu, roșu sau fumurie.

IT · Serie di sospensioni per interni, struttura in PMMA nero, diffusore in vetro soffiato ambra, blu, rosso o fumè.

RU · Серия люстр для интерьера, структура из черного PMMA, рассеиватель из стекла тонированного в янтарный, голубой, красный или дымчатый цвет.

HU · Beltéri függesztékek, fekete PMMA szerkezet, borostyán, kék, piros vagy füst színű fúvott üveg.

BG · Серия окачвания за интериор, черна структура от PMMA, дифузер от издухано стъкло в цвят кехлибар, синьо, червено или опушено.

SK · Sériá závesných interiérových svietidiel, čierna štruktúra PMMA sklenený difúzor v jantárovej, modrej, červenej alebo dymovej farbe.



INFO/DIMENSIONS

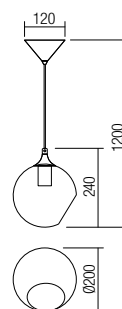

- 01-2323 Amber
- 01-2324 Blue
- 01-2325 Red
- 01-2326 Smokey

E27, 1 x max. 42W



Upper

Suspensions for interior, structure available in antique brass metal and natural wood or in metal and wood with black finish, cognac tinted or smoky grey blown glass lampshade.

RO · Suspensii pentru interior, structură disponibilă în variante din metal finisat alamă antică și lemn natur sau metal și lemn finisat negru, abajur din sticlă suflată cognac sau fumurie.

IT · Sospensioni per interni, struttura disponibile in metallo finitura ottone anticato e legno naturale o in metallo e legno finitura nera, diffusore in vetro soffiato cognac o fume.

RU · Люстры для интерьера, структура из металла в вариантах отделки состаренной латуни и натуральным деревом или металл и дерево черного цвета, абажур из стекла тонированного в коньячный или дымчатый цвет.

HU · Beltéri függesztékek, antik réz fémszerkezet natúr fa vagy fekete fémszerkezet és fekete fa kivitelben, fűjt konyak vagy füst színű üveggel.

BG · Висящи интериони осветителни тяла, метална структура в състарен месинг и натурално дърво или в метал и дърво с черен завършек. Абажур от боядисано или сиво опушено духано стъкло.

SK · Závesné interiérové svietidlá, konštrukcia je k dispozícii v starožitnom mosadznom a prírodnom dreve alebo v kove a dreve s čiernym povrchom, koňakom tónované alebo dymové sivé fúkané sklenené tienidlo.



01-1519



01-1518



01-1518

INFO/DIMENSIONS

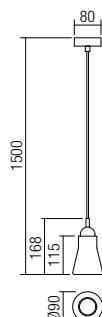

● 01-1518 Cognac

● 01-1519 Smoky

GU10, 1 x max. 28W



Pierce



Series of light fixtures for interior, metal structure painted in mat black or mat gold, blown glass diffusers with cognac or smoke finish.



01-2618

RO · Serie de corpuri de iluminat pentru interior, structură din metal vopsit negru mat sau auriu mat, dispersor din sticlă suflată cognac sau fumurie.

IT · Serie di apparecchi per interni, struttura in metallo verniciato nero opaco o oro opaco, diffusori in vetro soffiato cognac o fumè.

RU · Серия светильников для интерьера, структура из металла, покрашенного в матовый черный или матовый золотистый, стеклянный рассеиватель с напылением, с отделкой цвета коньяка или дыма.

HU · Beltéri világítótestek, matt fekete vagy matt arany fém szerkezet, konyak vagy füst színű fújt üveg.

BG · Серия осветителни тела за интериор, метална структура, боядисана в матово черно или матово златно, дифузер от коняково или опушено издухано стъкло.

SK · Sériá interiérových svietidiel, kovová konštrukcia lakovaná v matnej čiernej alebo matnej zlatej, difúzor z fúkaného skla s koňakovou alebo dymovou úpravou.



01-2617

INFO/DIMENSIONS

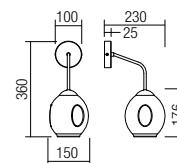

01-2617 Gold
01-2618 Black

E27, 1 x max. 42W





01-2619



01-2622

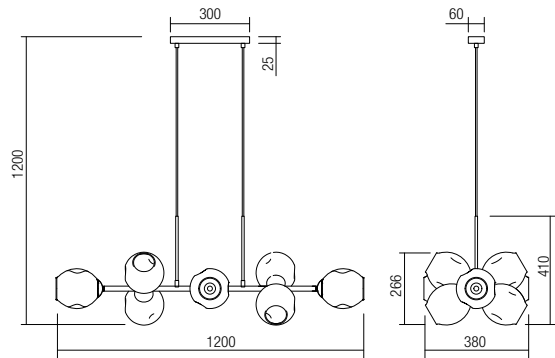
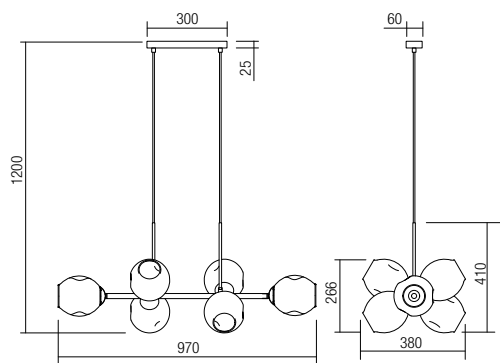

01-2619 Gold
01-2620 Black

E27, 6 x max. 42W



01-2621 Gold
01-2622 Black

E27, 8 x max. 42W



Vivienne



Series of interior light fittings, electrostatically painted in white with chromed details. Double diffusers of transparent blown glass with decoration at exterior and satinated at interior.

RO · Serie de corpuri de iluminat pentru interior, structură din metal vopsită în câmp electrostatic alb cu detalii cromate, dispersoare duble din sticlă suflată, transparente, cu decor la exterior și satinată la interior.

IT · Serie di apparecchi per interni, struttura in metallo verniciato a polveri bianco con particolari cromati, doppi diffusori in vetro soffiato, diffusore esterno trasparente con decorazione, diffusore interno satinato.

RU · Серия светильников для интерьера, со структурой из металла окрашенного в электростатическом поле в белый цвет с хромированными деталями, двойными рассеивателями из прозрачного выдувного стекла, декорированного снаружи и сатирированного внутри.

HU · Beltéri világítótestek, elektrosztatikus mezőben fehérre festett fémszerkezet, króm díszítéssel, dupla üveg diszperzorról, éspedig fújt áttetsző üveg kívül mintázott és belül mat.

BG · Серия интериорни осветителни тела, стлуктура от метал, електростатично боядисан в бяло с хромирани детайли, двойни разсейватели от духано стъкло, прозрачни, с украса отвън и сатенирани отвътре.

SK · Sériá interiérových svietidiel v bielej farbe s chrómovými detailami, dvojité difúzory z priehľadného skla, dekorované z vonkajšej strany.



01-1052



INFO/DIMENSIONS

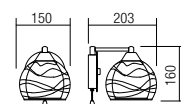

01-1052

E27, 1 x max. 42W

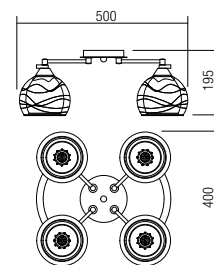

01-1053

E27, 4 x max. 42W



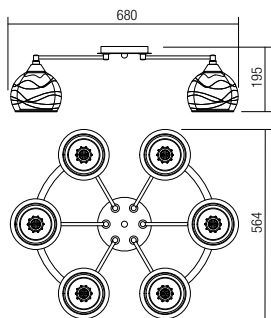

01-1054

**01-1054**

E27, 6 x max. 42W



01-1053



Light fixtures for interior, metal structure painted in sand black, smoky shaded glass diffusers.

RO · Corpuri de iluminat pentru interior, structură din metal vopsit negru mat, dispersoare din sticlă fumuriu degrade.

IT · Apparecchi per interni, struttura in metallo verniciato nero opaco, diffusori in vetro sfumato fumè.

RU · Светильники для интерьера, металлическая структура, окрашена в черный матовый цвет, рассеиватели из дымчатого стекла.

HU · Beltéri lámpatestek, matt fekete fém szerkezet, füst színű üveg.

BG · Светителни тела за интериор, метална структура боядисана в матово черно, дифузери от градиент опушено стъкло.

SK · Svetidlá pre interiér, kovová konštrukcia lakovaná do pieskovo čiernej, dymové sklenené tienidlo.



01-2176

01-2175

01-2177

INFO/DIMENSIONS

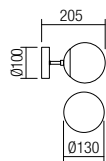
**01-2175**

E14, 1 x max. 28W

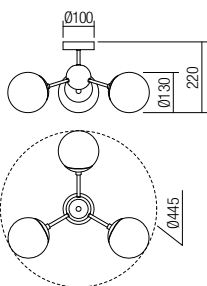
**01-2176**

E14, 3 x max. 28W

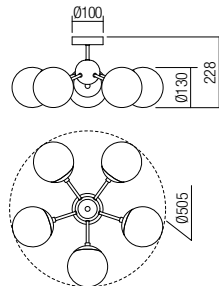
**01-2177**

E14, 5 x max. 28W





01-2177

Duke



Series of interior lamps, chromed metal structure with smoky glass shades.

RO · Serie de corpuri de iluminat pentru interior, structură din metal cromat, abajururi din sticlă fumé.

IT · Serie di apparecchi per interni, struttura in metallo cromato, paralumi in vetro fumé.

RU · Серия светильников для интерьера, структура из хромированного металла с абажурами из дымчатого стекла.

HU · Beltéri lámpa testek, krómozott fémszerkezet, füst színű üveg.

BG · Серия от интериорни лампи, хромна метална структура, абажур от опушено стъкло.

SK · Sériá interiérových svetidiel, kovová chrómová štruktúra, dymové sklenené tienidlá.



01-1509



INFO/DIMENSIONS

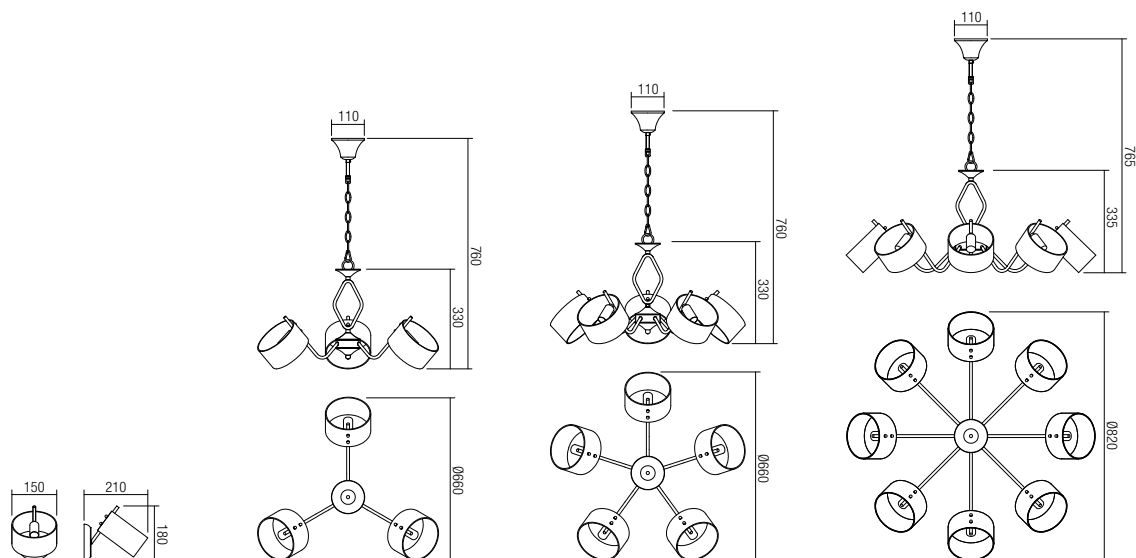

01-1509

E14, 1 x max. 28W



01-1510

E14, 3 x max. 28W



01-1511

E14, 5 x max. 28W



01-1512

E14, 8 x max. 28W





01-1512



01-1510



01-1511



01-1512

Rondo



Series of ceiling lamps with white opal blown glass diffuser, metal structure painted in white.

RO - Colectie de lămpi pentru interior, structură din metal vopsit alb și dispersoare din sticlă suflată alb opal.

IT - Serie di plafoniere con diffusore in vetro soffiato bianco opale, struttura in metallo verniciato bianco.

RU - Серия потолочных светильников с диффузором из вдуваемого стекла белого цвета опала, металлическая структура, окрашенная в белый цвет.

HU - Fehér opállal lefúvott üvegből készült mennyezeti lámpa sorozat, fehérre festett fém szerkezet.

BG - Вътрешни лампи, структура от хромиран метал, разпръсквач от хромиран метал с прилаган тъкан, декори от прозрачно стъкло.

SK - Sériá stropných svietidiel s bielym opálovým tienidlom z fúkaného skla, kovová konštrukcia v bielej farbe.



INFO/DIMENSIONS

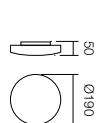

05-572

G9, 1 x max. 33W

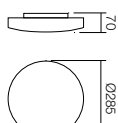

05-573

E27, 1 x max. 52W

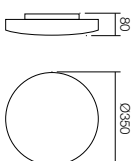

05-574

E27, 2 x max. 52W



05-574

Snoot

Series of interior suspensions, chromed metal body with transparent glass diffuser and decorative aluminum filaments.

RO · Serie de suspensii pentru interior, structură din metal cromat cu dispersor din sticlă transparentă și filamente decorative din aluminiu.

IT · Serie di sospensioni per interni, corpo in metallo cromato e diffusore in vetro trasparente con filamenti decorativi in alluminio.

RU · Серия подвешток для внутреннего освещения, корпус из хромированного металла, диффузор из прозрачного стекла, алюминиевые декоративные нити.

HU · Beltéri felfüggesztés sorozat, krómozott fém szerkezet és áttetsző diszperzór, alumínium diszító izzóval.

BG · Серия интериорни окачвания, структура от хромиран метал с разсейвател от прозрачно стъкло и декоративни алуминиеви нишки.

SK · Rad závesných svietidiel, chrómované kovové telo s priehľadným skleneným difúzorom s použitím dekoratívnych hliníkových vlákien.



01-887



01-888

INFO/DIMENSIONS

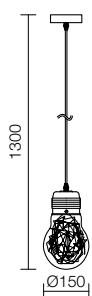

01-887

E27, 1 x max. 42W

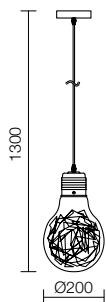

01-888

E27, 1 x max. 42W



01-888

Kleidi



Series of suspensions for indoor, structure of metal painted in satin gold and natural wood or of metal painted in mat black and black finished wood, white opal blown glass diffuser.

RO · Serie de suspensii pentru interior, structură din metal vopsit aur mat și lemn natur sau din metal vopsit negru și lemn finisat negru, dispersor din sticlă suflată alb opal.

IT · Sospensioni per interni, struttura in metallo verniciato oro opaco e legno fibra naturale o in metallo verniciato nero opaco e legno finitura nero, diffusore in vetro soffiato bianco opale.

RU · Серия люстр для интерьера, структура из металла окрашенного в золотой цвет и натурального дерева или из дерева и металла окрашенных в черный цвет, рассеиватель из белого опалового стекла.

HU · Beltéri függesztékek, matt arany fémszerkezet és natúr fa, vagy fekete fémszerkezet és fa.

BG · Серия окачвания за интериор, метална структура боядисана в матово злато и естествено дърво или от боядисан метал в цвят черно или черно дърво, дифузор от издухано опалово бяло стъкло.

SK · Sériu závesných interiérových svietidiel, kovová štruktúra lakovaná v saténovej zlatej s prírodným drevom, alebo v matnej čiernej s drevom s čiernou povrchovou úpravou, difúzor z bieleho opalového skla.

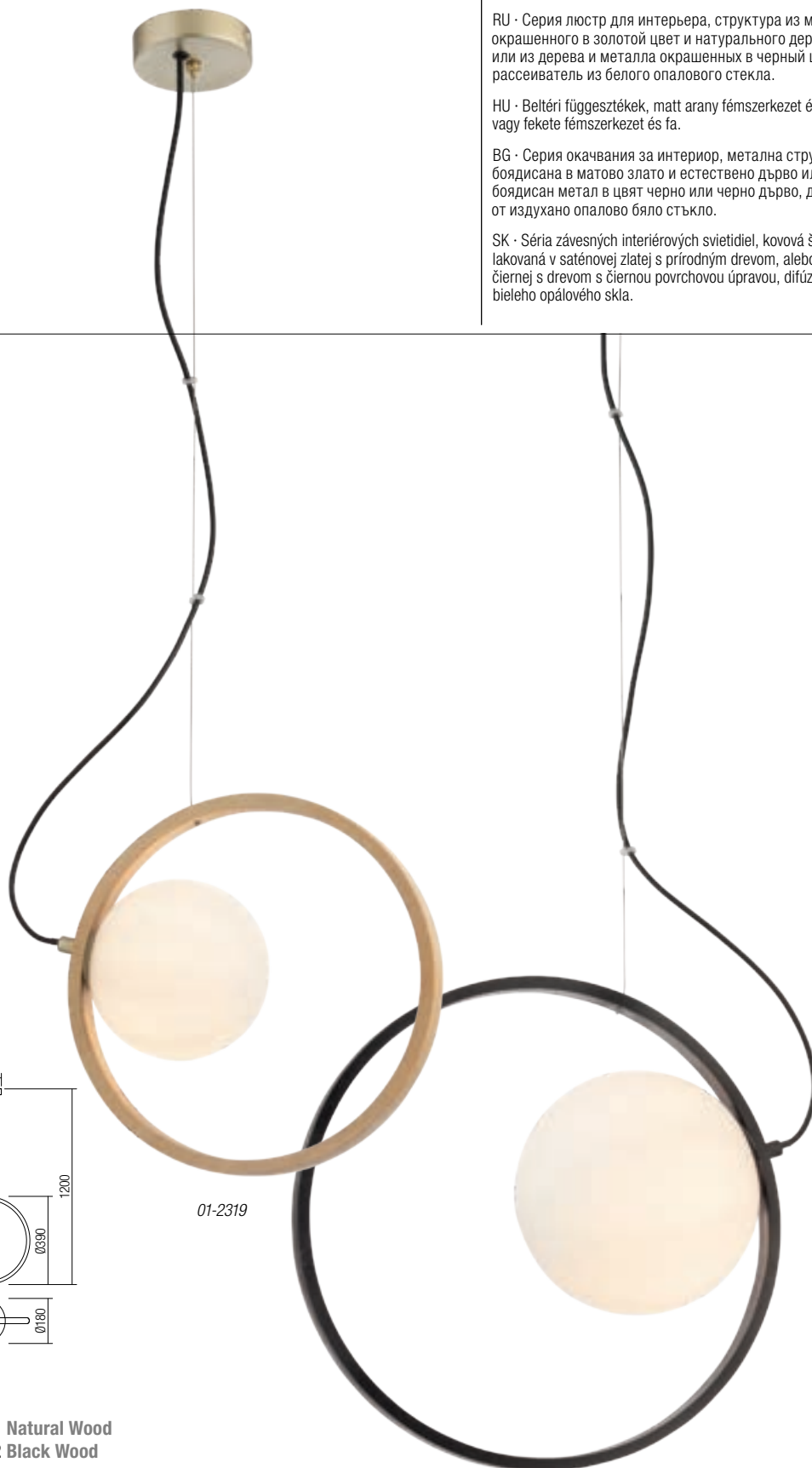

INFO/DIMENSIONS

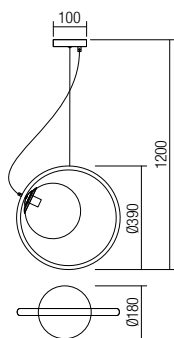
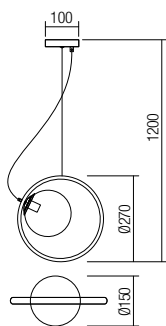

01-2319

01-2322



● 01-2319 Natural Wood
● 01-2320 Black Wood

E14, 1 x max. 28W



● 01-2321 Natural Wood
● 01-2322 Black Wood

E27, 1 x max. 42W





01-2321



Kim

Collection of lamps with chromed metal and wood structure finished in wenge, white opal blown glass lampshade.

RO · Colecție de lămpi cu structură din metal cromat și lemn finisat wenge cu abajur din sticlă suflată alb opal.

IT · Collezione di lampade con struttura in metallo cromato e legno finitura wenge, diffusore in vetro soffiato bianco opale.

RU · Коллекция светильников с металлической хромированной структурой, отделочный слой деревянный слой цвета "венге" с выдуваемым стеклянным абажуром белого цвета опала.

HU · Wengefa és krómozott fém szerkezetű világítótestek sorozat, fehér opállal lefűvött üveg lámpaernyővel.

BG · Колекция лампи с хроматна метална структура и венге завършено дърво със абажур от издухано бяло опално стъкло.

SK · Kolekcia svietidiel z chrómovaného kovu a štruktúry dreva Wenge, s bielym opáľovo fúkaným skleným tienidlom.



01-475



01-476

INFO/DIMENSIONS

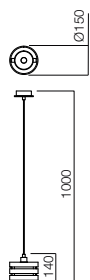
**01-475**

E14, 1 x max. 28W

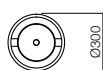
**01-476**

E27, 1 x max. 42W





01-476



01-627



01-474

INFO/DIMENSIONS

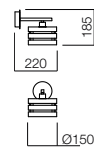

01-474
E14, 1 x max. 28W

IP20 230V 50Hz

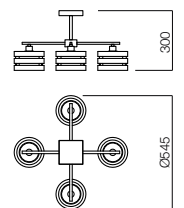

01-627
E14, 4 x max. 28W

IP20 230V 50Hz

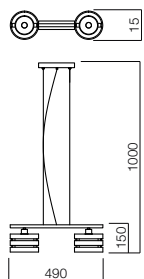
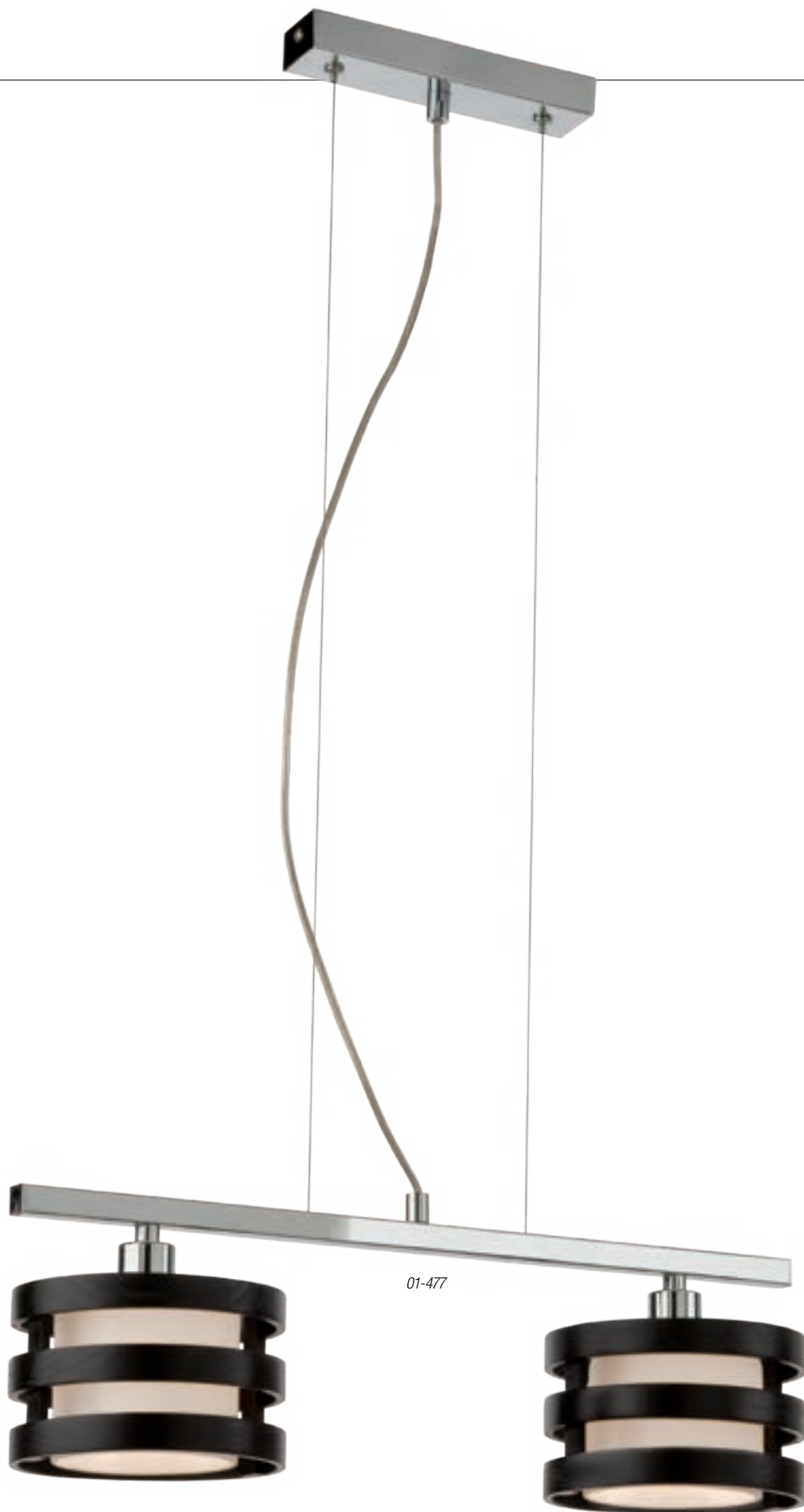

01-477

E14, 2 x max. 28W



Shape



Series of interior light fittings, chromed metal and wood structure finished in wenge, opal blown glass lampshades.

RO - Serie de corpuri de iluminat pentru interior, structură din metal cromat și lemn finisat wenge, abajururi din sticlă suflată opal.

IT - Serie di lampade per interni, struttura in metallo cromato e legno finitura wengè, paralumi in vetro soffiato opale.

RU - Серия светильников для внутреннего освещения, конструкция из хромированного металла и дерева с отделочным слоем венге, абажуры из выдувного стекла опалового цвета.

HU - Beltéri világítótest sor, krómozott és wenge fa díszítéses fémszerkezettel, fűvottüveg opál lámpaernyőekkel.

BG - Серия интериорни осветителни тела, структура от хромиран метал и дърво с покритие венге, абажури от духано стъкло опал.

SK - Rad interiérových svietidiel z chrómovaného kovu a štruktúrou dreva Wenge, opalové fúkané sklené tienidlo.



01-1027



01-1029



01-1028

INFO/DIMENSIONS

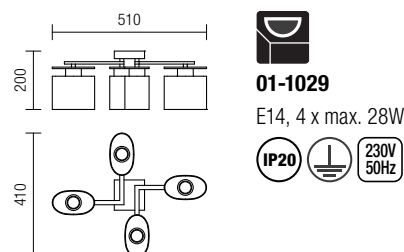
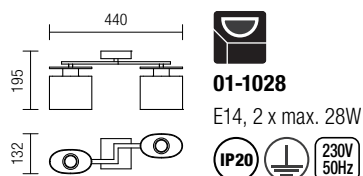
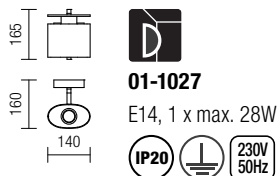



01-1029

Pooh



Series of light fixtures for interior, structure of metal painted in mat black and natural beech wood, metal diffusers electrostatically painted in mat black in exterior and white in interior.

RO · Serie de corpuri de luminat pentru interior, structură din metal vopsit negru mat și lemn de fag natur, dispersoare din metal vopsit negru mat la exterior și alb la interior.

IT · Serie di apparecchi per interni, struttura in metallo verniciato nero opaco e legno di faggio naturale, diffusori in metallo verniciato nero opaco all'esterno e bianco internamente.

RU · Серия светильников для интерьера, структура из металла, покрашенного в матовый черный и под натуральное буковое дерево, металлические рассеиватели с электростатической покраской в матовый черный цвет снаружи и белый с внутренней стороны.

HU · Beltéri lámpa testek, matt fekete fém szerkezet natur bükkfa betéttel, kívül matt fekete belül fehér színű fé ernyővel.

BG · Серия осветителни тела за интериор, метална структура, боядисана в матово черно и естествено буково дърво, метални дифузери, боядисани в матово черно отвън и бяло отвътре.

SK · Sériá interiérových svietidiel, konštrukcia z kovu lakovaného matnou čiernou s prírodným bukovým drevom, kovové difúzory elektrostaticky lakované matne čiernou farbou v zvonka a bielou v zvnútra.



01-2404



01-2399



01-2399



01-2402



01-2405

Pooh

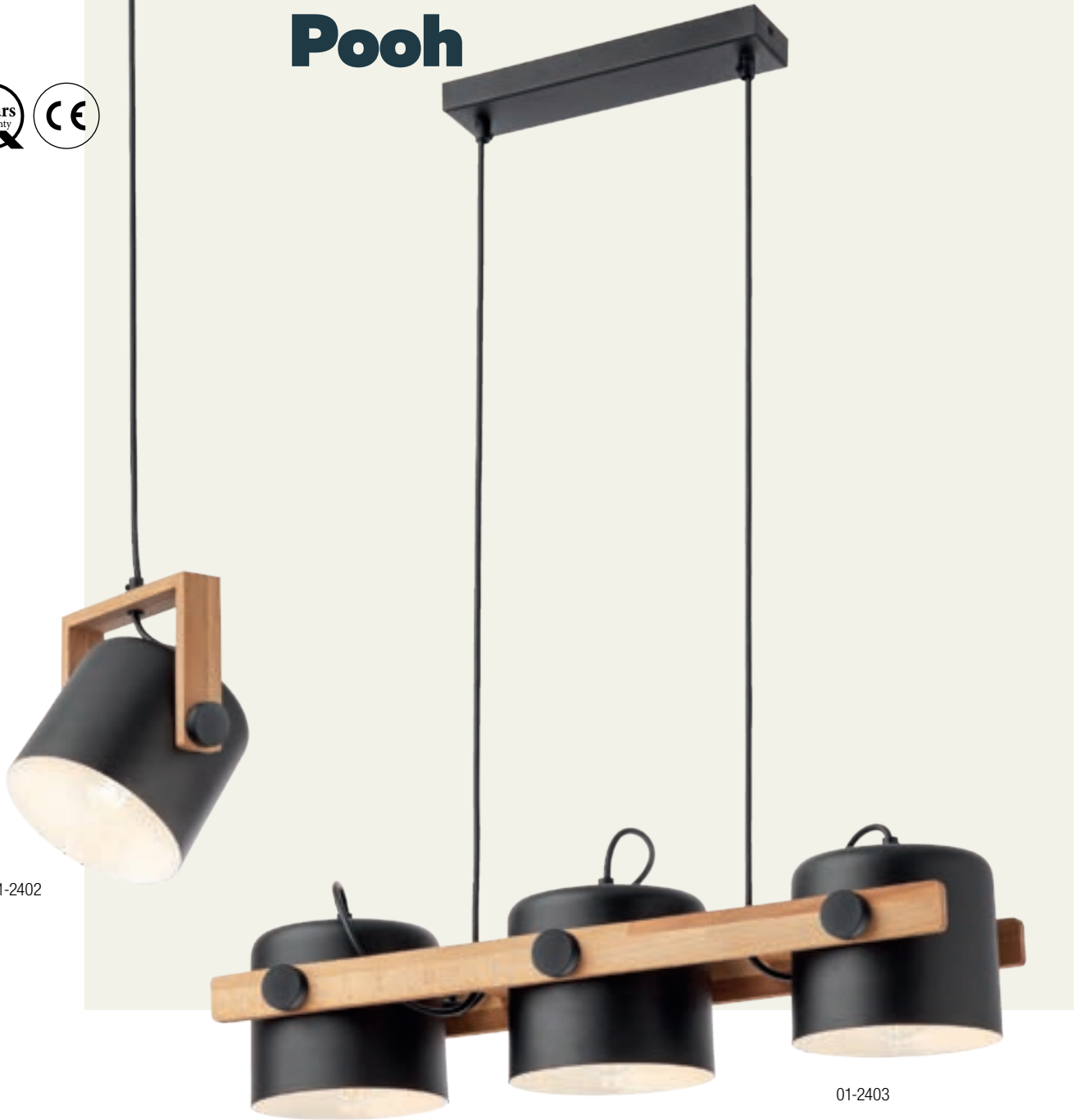

01-2402

01-2403

INFO/DIMENSIONS

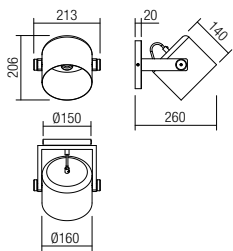

01-2399
E27, 1 x max. 42W

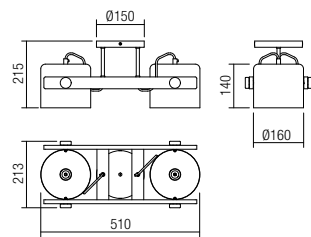

01-2400
E27, 2 x max. 42W

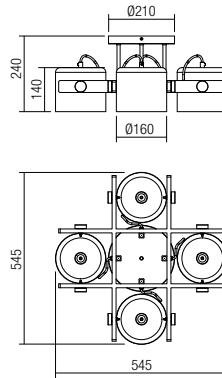

01-2401
E27, 4 x max. 42W

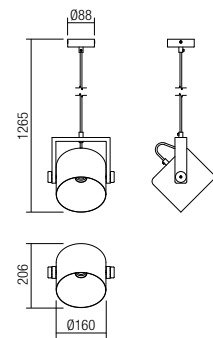

01-2402
E27, 1 x max. 42W



01-2400

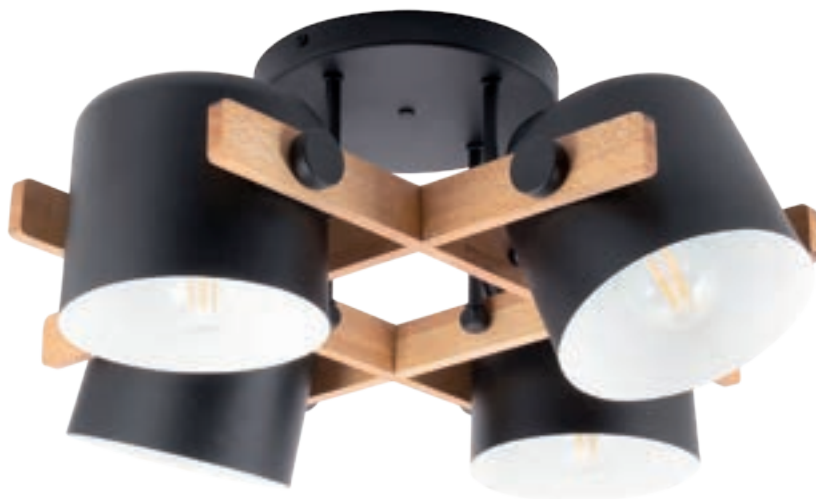

01-2401

INFO/DIMENSIONS

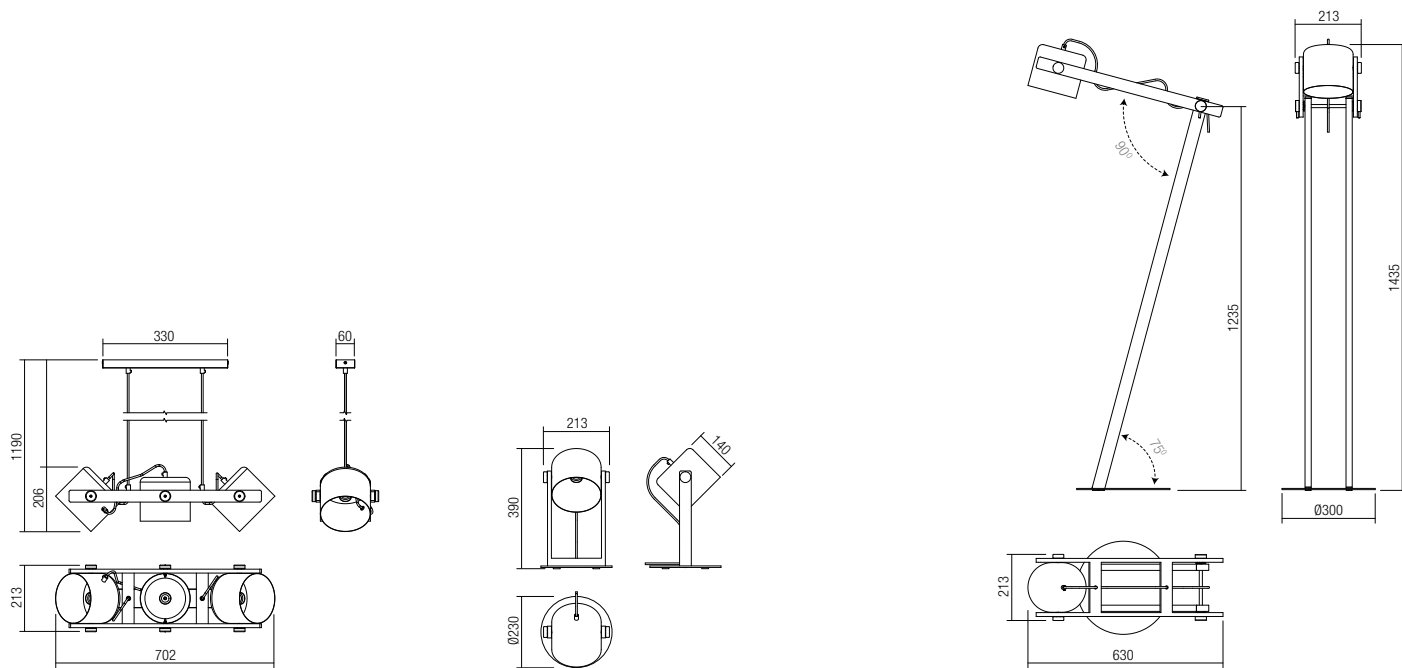

01-2403
E27, 3 x max. 42W
IP20 230V 50Hz

01-2404
E27, 1 x max. 42W
IP20 230V 50Hz

01-2405
E27, 1 x max. 42W
IP20 230V 50Hz

Aeris



Series of light fixtures for interior, metal structure electrostatically painted in mat black and natural wood detail.

RO · Serie de corpuri de iluminat pentru interior, structură din metal vopsit în câmp electrostatic negru mat cu detalii din lemn natur.

IT · Serie di apparecchi per interni, struttura in metallo verniciato a polveri nero opaco con dettaglio in legno naturale.

RU · Серия светильников для интерьера, металлическая структура с электростатической покраской в матовый черный цвет и с деталями из натурального дерева.

HU · Beltéri lámpa testek, elektrosztatikus mezőben festett matt fekete színű fém szerkezet fa betéttel.

BG · Серии осветителни тела за интериор, метална структура, боядисана в електростатично поле в матово черно, с детайл от естествено дърво.

SK · Sériá interiérových svietidiel, kovová konštrukcia elektrostaticky lakovaná v matnej čiernej farbe a detailoch z prírodného dreva.



01-2408



01-2406

INFO/DIMENSIONS

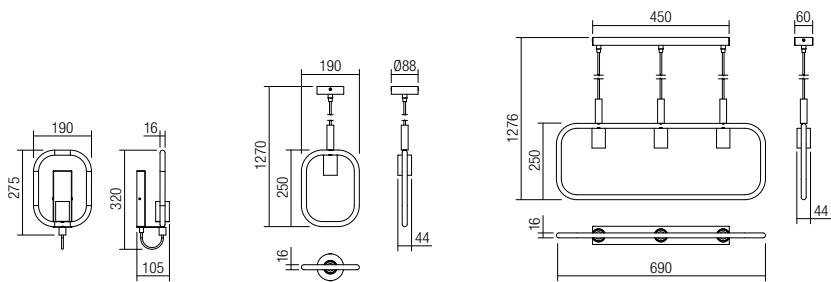

01-2406

E27, 1 x max. 42W



01-2407

E27, 1 x max. 42W



01-2408

E27, 3 x max. 42W

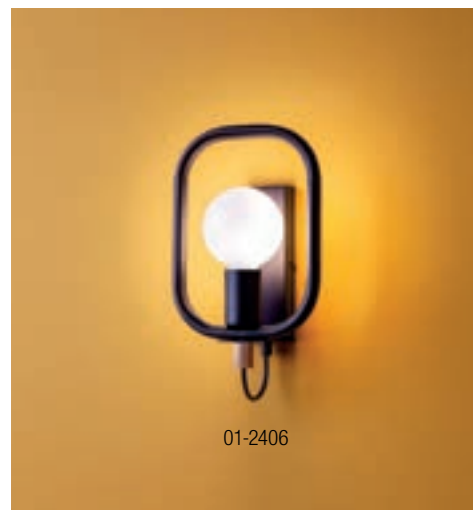

01-2406



01-2408



01-2407



Light fixtures for interior, structure of metal painted in sand black and natural beech wood.

RO · Corpuri de iluminat pentru interior, structură din metal vopsit negru mat și lemn de fag natur.

IT · Apparecchi luminosi per interni, struttura in metallo verniciato nero opaco e legno di faggio naturale.

RU · Светильники для интерьера, структура из металла, покрашенного в матовый черный и под натуральное буковое дерево.

HU · Beltéri mennyezeti lámpák, matt fekete fém szerkezet natur bükkfa betéttel.

BG · Осветителни тела за интериор, метална структура, боядисана в матово черно и естествено буково дърво.

SK · Interiérové svietidlá, konštrukcia z kovu lakovaná pieskovou čiernou s prírodným bukovým drevom.



01-2418



01-2417



01-2416

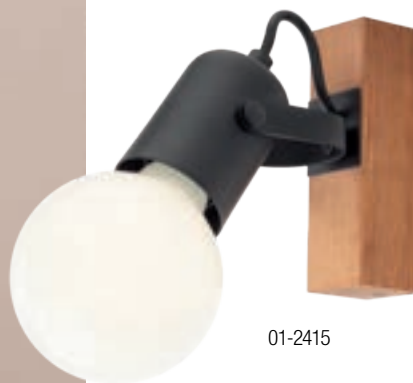

01-2415

INFO/DIMENSIONS

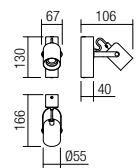

01-2415
E27, 1 x max. 42W

IP20

230V
50Hz

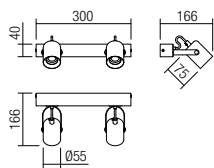

01-2416
E27, 2 x max. 42W

IP20

230V
50Hz

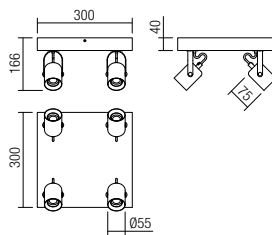

01-2417
E27, 4 x max. 42W

IP20

230V
50Hz

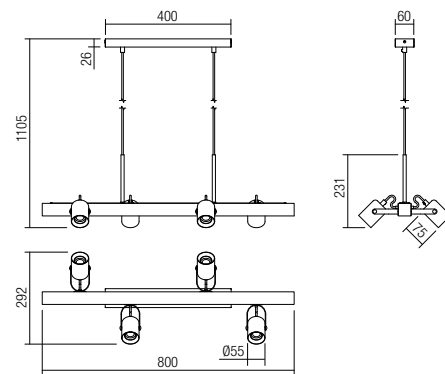

01-2418
E27, 4 x max. 42W

IP20

230V
50Hz

Timber



Series of lamps for interior, structure of metal painted in mat black and natural beech wood.

RO - Serie de corpuri pentru interior, structură din metal vopsit negru mat și lemn de fag natur.

IT - Serie di apparecchi per interni, struttura in metallo verniciato nero opaco e legno di faggio naturale.

RU - Серия светильников для интерьера, структура из металла окрашенного в черный матовый цвет и натурального букового дерева.

HU - Beltéri lámpatestek, matt fekete fémszerkezet natúr bükk fabetéttel.

BG - Серия от интериорни лампи, метална основа, боядисана в черен мат и натурален бук.

SK - Série interiérových svietidiel, štruktúra kovu lakovaná v matnej čiernej a prírodnom buku.

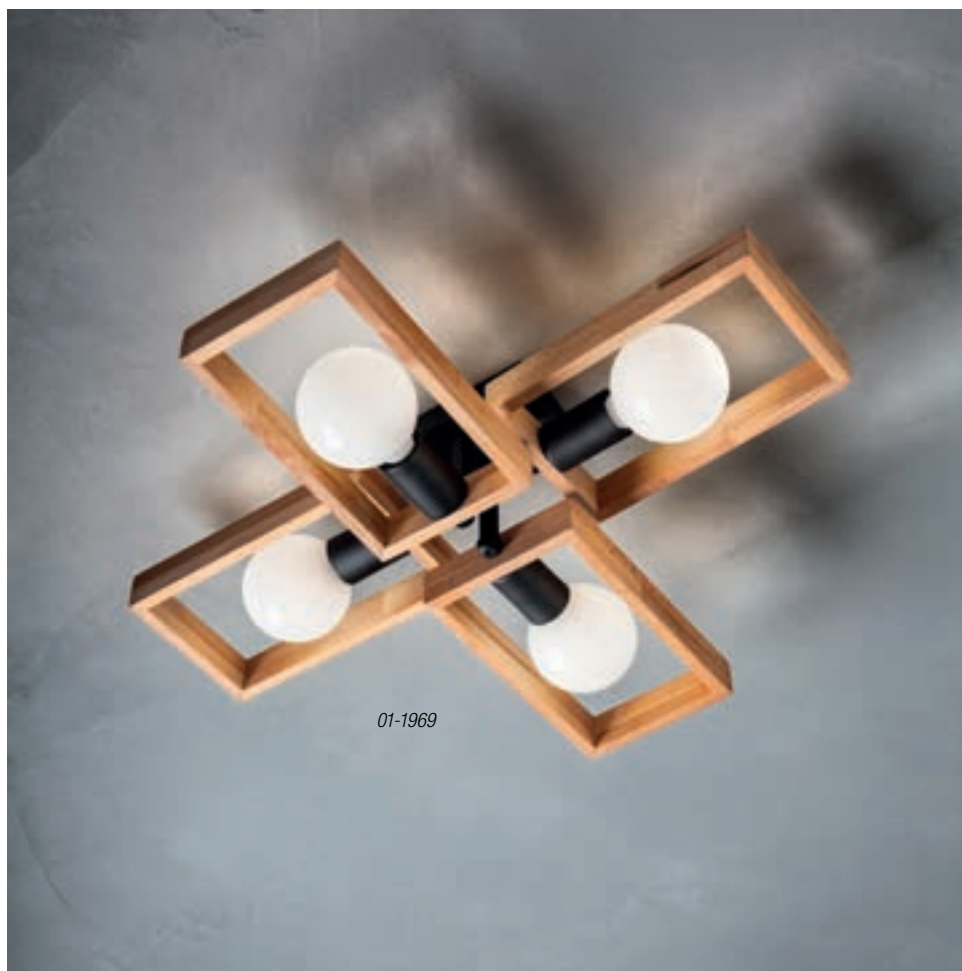

01-1969

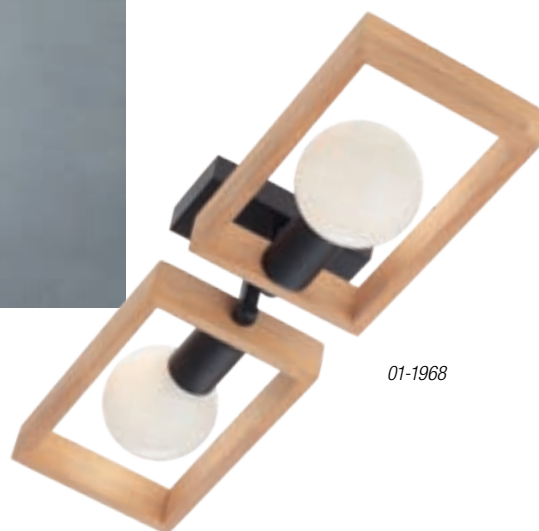

01-1968



01-1664

INFO/DIMENSIONS

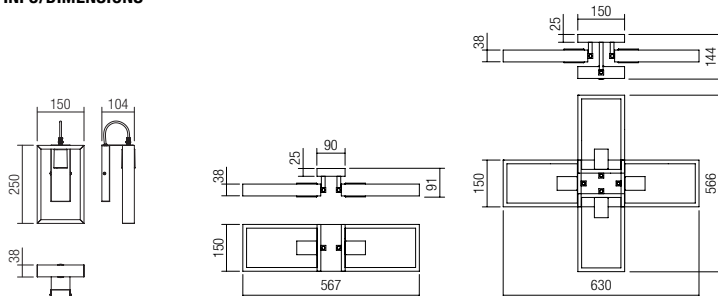

01-1663

E27, 1 x max. 42W



01-1968

E27, 2 x max. 42W



01-1969

E27, 4 x max. 42W





01-1663

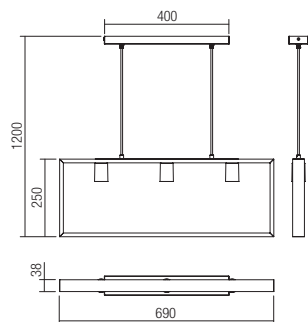

01-1665
 E27, 3 x max. 42W
 IP20 230V 50Hz

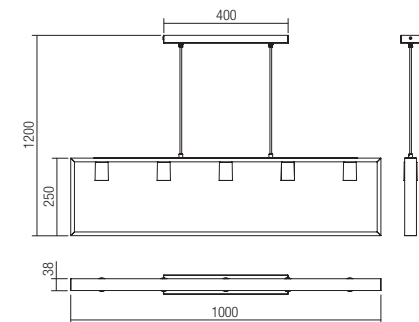

01-1666
 E27, 5 x max. 42W
 IP20 230V 50Hz

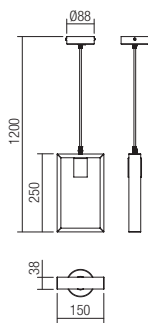

01-1664
 E27, 1 x max. 42W
 IP20 230V 50Hz



01-1664



01-1666

01-1665

Easy



Series of interior lamps with orientable arms, metal structure electrostatically painted in mat black with natural wood details.

RO · Serie de lămpi pentru interior cu brațe orientabile, structură din metal vopsit în câmp electrostatic negru mat cu detalii din lemn natur.

IT · Serie di lampade per interni con bracci orientabili, struttura in metallo verniciata a polveri nero opaco, dettagli in legno naturale.

RU · Серия светильников для интерьера с регулируемыми кронштейнами, структура из металла, окрашенного в электростатическом поле в черный матовый цвет с отделкой из натурального дерева.

HU · Mozgatható karú beltéri lámpatestek, elektrosztatikus mezőben matt feketére festett fémszerkezet, natúr fa betéttel.

BG · Серия от интериорни лампи, с насочващи рамена, метална структура, електростатично боядисани в черен мат, с детайли от натурално дърво.

SK · Sériá interiárových svietidiel s nastaviteľnými ramenami, kovová konštrukcia elektrostaticky lakovaná v matnej čiernej farbe s detailmi z prírodného dreva.



01-1568



01-1567



01-1566

INFO/DIMENSIONS

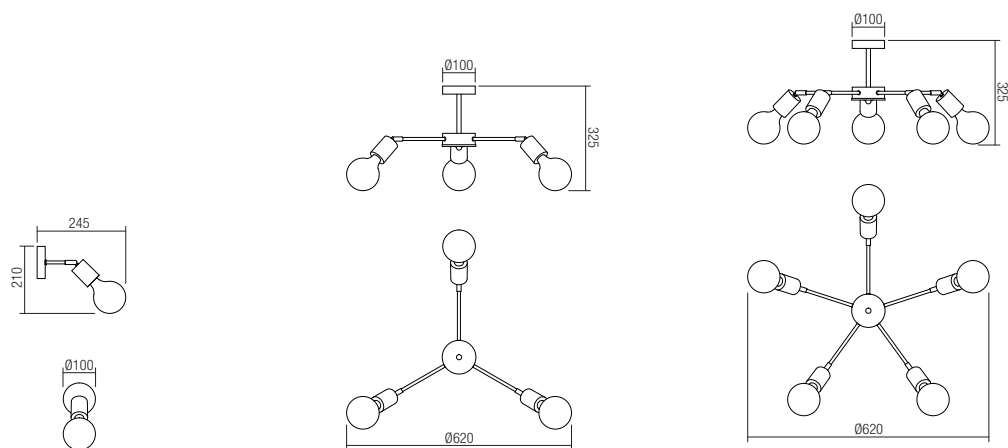
**01-1566**

E27, 1 x max. 42W

**01-1567**

E27, 3 x max. 42W

**01-1568**

E27, 5 x max. 42W



Ilusio

Suspension for interior, metal structure painted in black with chromed elements, diffuser made of natural wood concentric rings.

RO · Suspensie pentru interior, structură din metal vopsit negru și elemente cromate, dispersor realizat din cercuri concentrice de lemn natur.

IT · Sospensione per interni, struttura in metallo verniciato nero con elementi cromati, diffusore composto da cerchi in legno naturale.

RU · Люстра для интерьера, структура из металла окрашенного в черный цвет с хромированными элементами, рассеиватель выполнен в виде концентрических колец из натурального дерева.

HU · Beltéri függeszték, fekete fémszerkezet króm részekkel, koncentrikus körökből álló natúr fa diszperzór.

BG · Висящо интериорно осветително тяло, метална основа, боядисана в черно с хромни елементи. Дифузер, изработен от натурално дърво с концентичи пръстени.

SK · Závěsné interiérové svetidlo, kovová konštrukcia lakovaná v čiernej farbe s chrómovanými prvkami, difúzor s prstencami z prírodného dreva.



INFO/DIMENSIONS

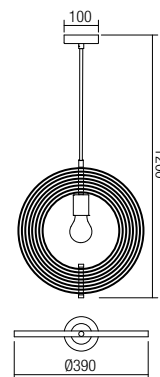

01-1670

E27, 1 x max. 42W





01-1670



Melia



Series of light fixtures for interior, structure of chromed metal, black fabric shade on gold PVC support diffuser, with laser cut decoration. Ceiling lamps are fitted with white PVC diffuser.

RO · Serie de corpuri de iluminat pentru interior, structură din metal cromat, abajur din țesătură culoare neagră pe suport PVC auriu, modelat cu laser. Plafonierele sunt prevăzute cu dispersor din PVC alb.

IT · Serie di apparecchi per interni, struttura in metallo cromato, paralume in tessile nero rivestito in PVC oro modellato con taglio laser. Plafoniere dotate con diffusore in PVC bianco.

RU · Серия светильников для интерьера, структура из хромированного металла, черный тканевый абажур с основой из ПВХ золотого цвета, с лазерной отделкой. Потолочные светильники оснащены рассеивателем из белого ПВХ.

HU · Beltéri lámpatestek, króm fém szerkezet, fekete szövet ernyő, lézerrel megmunkált PVC tartó. A mennyezeti lámpák fehér PVC diszperzórral vannak ellátva.

BG · Серия осветителни тела за интериор, структура от хромиран метал, черен текстилен абажур на PVC златна поставка, лазерно моделирана. Таванните осветления разполагат с бял PVC дифузер.

SK · Sérija svietidiel pre interiér, štruktúra chrómovaného kovu, čierne textilné tienidlo na zlatom PVC podpornom difúzore, s laserom zdobenou dekoráciou. Stropné svietidlá sú vybavené bielym PVC difúzorom.



01-2138



01-2139



01-2137

INFO/DIMENSIONS

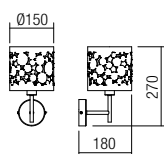

01-2137

E14, 1 x max. 28W

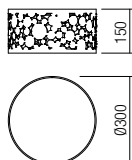

01-2138

E27, 2 x max. 42W

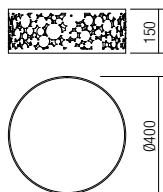

01-2139

E27, 3 x max. 42W





01-2137



01-2140



01-2142

INFO/DIMENSIONS

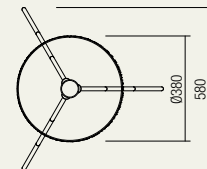
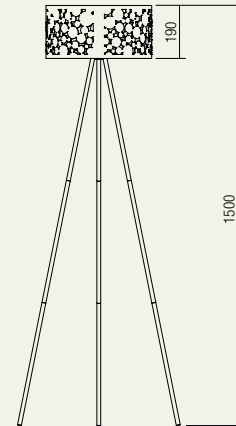

01-2141

E27, 1 x max. 42W



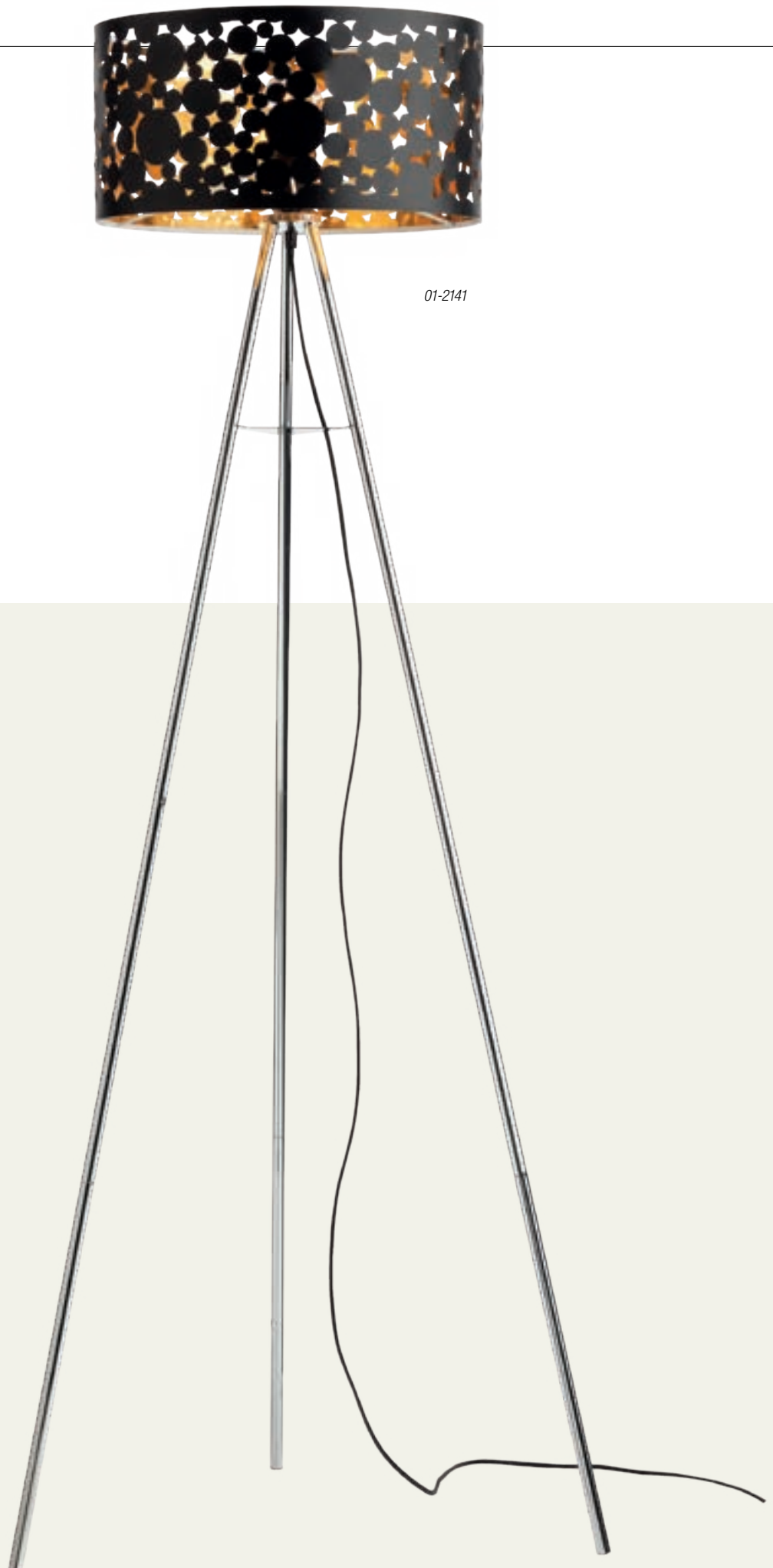

01-2141



200



Ø120

**01-2142**

E14, 1 x max. 28W

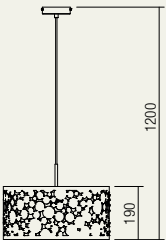
230V
50Hz

1200

190



Ø88

**01-2140**

E27, 1 x max. 42W

230V
50Hz

Astrid

Series of interior light fittings, chromed metal structure and transparent pyrex tube with glass decorations, silver fabric shade.



01-1176



RO - Serie de corpuri de iluminat pentru interior, structură din metal cromat și tub din pyrex transparent cu decorațiuni din sticlă, abajur textil argintiu.

IT - Serie di apparecchi per interni, struttura in metallo cromato, tubo in pyrex trasparente con decorazioni in vetro, paralume in tessile argento.

RU - Серия светильников для интерьера, структура из хромированного металла и трубки из прозрачного пирекса декорирована элементами из стекла, абажур из серебристой ткани.

HU - Beltéri világítótétek, króm fémszerkezet, átlátszó üveg díszítéssel, ezüst textil ernyővel.

BG - Серия интериорни осветителни тела, структура от хромиран метал и тръба от прозрачно огнеупорно стъкло със стъквени украшения, сребрист текстилен абажур.

SK - Sériá interiérových svietidiel, chrómová kovová štruktúra, transparentná rúrka so sklenenými ozdobami, strieborná tkanina.

INFO/DIMENSIONS

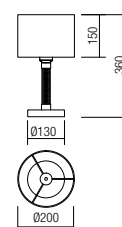
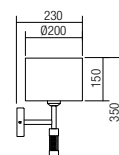

01-1176

E27, 1 x max. 42W



01-1178

E27, 1 x max. 42W

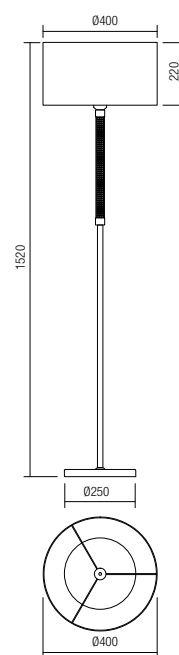
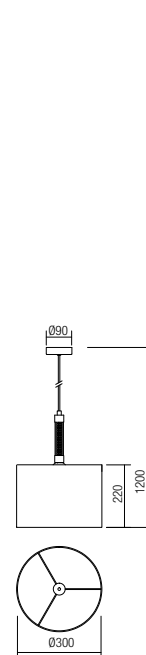

01-1177

E27, 1 x max. 42W



01-1179

E27, 1 x max. 42W





01-1177



01-1179



01-1176



01-1178

Metis



Series of suspensions for interior, equipped with SMD LEDs, chromed metal structure, injection molded diffuser of transparent acryl, crystal effect.

RO · Serie de suspensii pentru interior, echipate cu LED-uri SMD, structură din metal cromat, dispersor din acril transparent amprentat efect cristal.

IT · Serie di sospensioni per interni, equipaggiate con LED SMD, struttura in metallo cromato, diffusore stampato ad iniezione in acrilico trasparente, effetto cristallo.

RU · Серия подвесных люстр для интерьера, оснащенных светодиодами SMD, хромированная металлическая структура, рассеиватель из прозрачного акрила с тисненным кристаллическим эффектом.

HU · Beltéri függesztékek, SMD LED-el szerelve, króm fémszerkezet, attetsző acril diszperzór, kristályos hatással.

BG · Серия интериорни полилеи, оборудвани със SMD LED-ове, структура от хромиран метал, инжекционно формован разсейвател от прозрачен акрил с кристален ефект.

SK · Sériá interiérových závesných svetidiel, vybavená LED SMD diódami, chrómová kovová konštrukcia, difúzor s priehľadného akrylu a kryštálovým efektom.



01-1391



01-1390

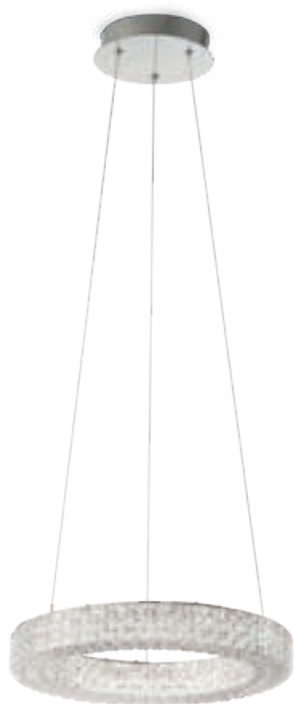

01-1389

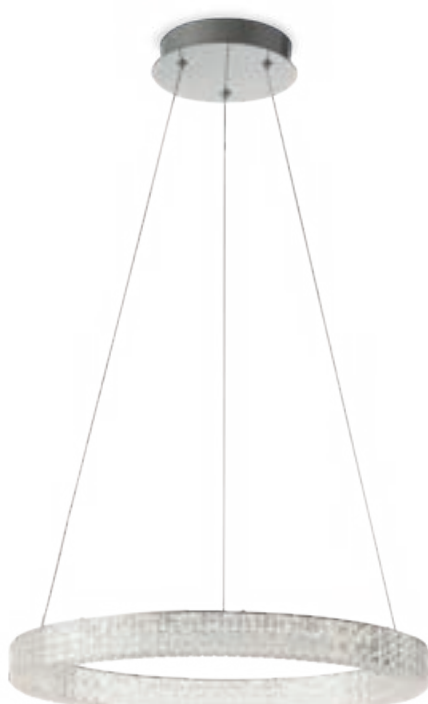

01-1390

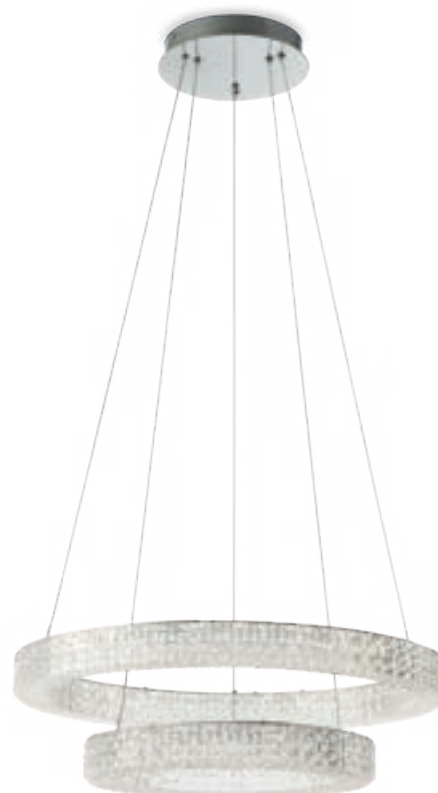

01-1391

INFO/DIMENSIONS

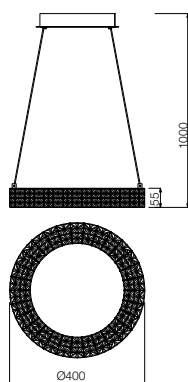

01-1389
SMD LED · 21W · 4000K · CRI 82
LED flux 2380 lm
Luminaire flux 1512 lm

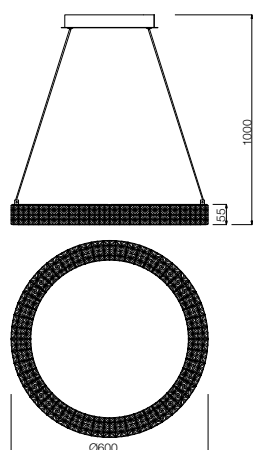

01-1390
SMD LED · 38W · 4000K · CRI 82
LED flux 4400 lm
Luminaire flux 2774 lm

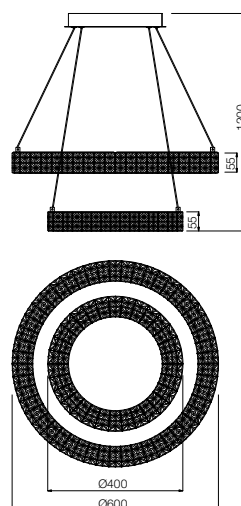

01-1391
SMD LED · 60W · 4000K · CRI 82
LED flux 7050 lm
Luminaire flux 4496 lm



Arcadia



Series of interior light fittings, chromed metal structure, glossed acryl diffuser with transparent nylon threads weave.

RO - Serie de corpuri de iluminat pentru interior, structură din metal cromat și dispersor din acril oglindat cu împletitură din fire de nylon transparent.

IT - Serie di apparecchi per interni, struttura in metallo cromato, diffusore in acrilico specchiante e intrecci in fili di nylon trasparente.

RU - Серия светильников для интерьера, хромированная металлическая конструкция, глянцевый акриловый рассеиватель с вплетением из прозрачной нейлоновой нити.

HU - Beltéri világítótételek, króm fémszerkezet, tükör akril diszperzór, áttetsző nylon szál bevonattal.

BG - Серия интериорни осветителни тела, структура от хромиран метал, разсейвател от огледален акрил с прозрачни найлонови нишки.

SK - Série interiérových svietidiel, chrómová kovová konštrukcia, akrylový difúzor s nylonom.



INFO/DIMENSIONS

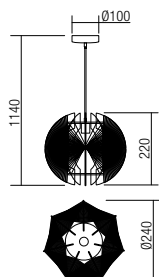

01-1245

E14, 1 x max. 28W

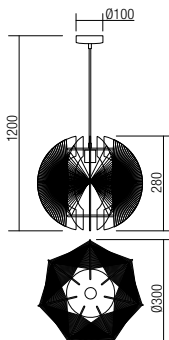

01-1246

E27, 1 x max. 42W

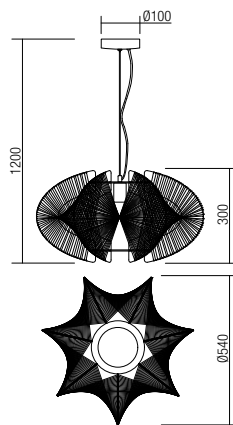

01-1467

E27, 1 x max. 42W

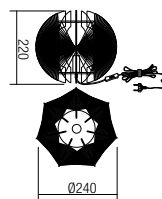

01-1247

E14, 1 x max. 28W





01-1245



01-1467



01-1246



01-1247

Coline



Suspensions for interior, plastic structure in silver color, with double decorative diffuser: exterior of polycarbonate available in amber, red and green, interior made of blown opal glass shade.

RO · Suspensii pentru interior, structură din material plastic culoare argintie, prevăzute cu un dublu dispersor decorativ: la exterior din policarbonat în variante de culori ambră, roșu și verde iar la interior din sticlă suflată opal.

IT · Sospensioni per interni, struttura in plastica argento, doppio diffusore decorativo: all'esterno in policarbonato disponibile in diverse varianti colore ambră, rosso e verde, all'interno in vetro soffiato bianco.

RU · Подвески для внутреннего освещения, структура из пластматериала серебристого цвета, предусмотренные двойным декоративным диффузором: на наружной стороне из поликарбоната в варианте исполнения цвета янтарного, красного и зеленого цвета, а на внутренней стороне из выдувного стекла опалевое цвета.

HU · Beltéri felfüggesztések, ezüst színű műanyag szerkezet, ellátva kettős díszítő diszperzórral: külső fele alabástrom, piros és zöld színű polikarbonát, belső fele opálos üveg.

BG · Интериорни полилеи, пластмасова структура, сребрист цвят, оборудвани с двоен декоративен разсейвател: отвън от поликарбонат в цветови варианти кехлибар, червено и зелено, а отвътре от духано стъкло в опал.

SK · Závesné svietidlo pre interiér, strieborný plastový rámik, ozdobný dvojité difúzor: vonku z polykarbonátu v dispozícii v rôznych farbách žltá, červená a zelená, biele fúkané sklo.

06-032

INFO/DIMENSIONS

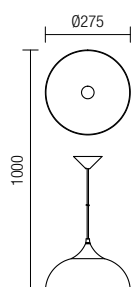

06-033

06-034



- 06-032 Red
- 06-033 Amber
- 06-034 Green

E27, 1 x max. 42W



Tracy



Suspensions for interior, polypropylene structure and ornaments available in white or black.

RO · Suspensii pentru interior, structură și ornamente din polipropilenă disponibile în alb sau negru.

IT · Sospensioni per interni, struttura e decori in polipropilene disponibili in bianco o nero.

RU · Люстры для интерьера, полипропиленовая структура и орнаменты, доступные в белом или черном цвете.

HU · Beltéri függesztékek, fehér vagy fekete polipropinén dísz és szerkezet.

BG · Интериорни висящи осветителни тела, корпус от полипропилен и орнаменти в бяло или черно.

SK · Závěsné interiérové svietidlá, polypropylénová štruktúra a ornamenty dostupné v bielej alebo čiernej farbe.

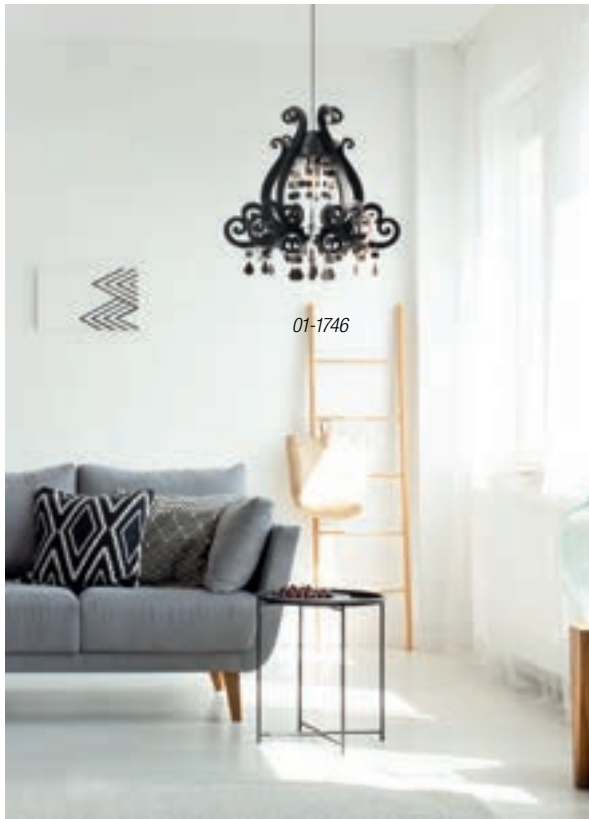

01-1746



01-1746

INFO/DIMENSIONS

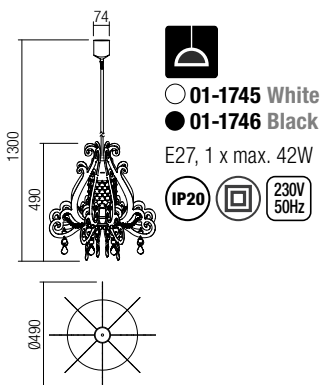

01-1745

Butterfly



Suspension for interior, metal structure electrostatically painted in white, diffuser of polypropylene ornaments butterfly-shaped.

RO · Suspensie pentru interior, structură metalică vopsită în câmp electrostatic culoare albă, dispersor realizat din ornamente din polipropilenă în formă de fluture.

IT · Sospensione per interni, struttura metallica verniciata bianco a polveri, diffusore composto da ornamenti in polipropilene bianco a forma di farfalla.

RU · Подвеска для внутреннего освещения, металлическая структура, окрашенная в электростатическом поле белого цвета, диффузор из полипропиленовых украшений в форме бабочки.

HU · Beltéri felfüggesztés, elektrosztatikus mezőben fehérre festett fémszerkezet, polipropilénből készült lepke alakú díszítő elemekből készült diszperzór.

BG · Интериорен полилей, метална структура, боядисана в електростатично поле, цвят бял, разсейвател от полипропиленови орнаменти под формата на пеперуди.

SK · Závesné svietidlo pre interiér, konštrukcia z kovu, elektrostaticky lakované vo farbe bielej, difúzor z polypropylénu s ornamentálnou podobou motýľa.



01-781

INFO/DIMENSIONS

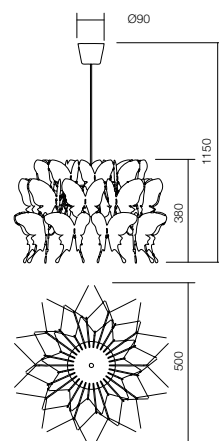

01-781

E27, 1 x max. 23W





Odeon



Suspension for interior, structure of white and transparent plastic, lampshade of gold polypropylene elements.

RO · Suspensie pentru interior, structură din plastic alb și plastic transparent, abajur din elemente de polipropilenă aurie.

IT · Sospensione per interni, struttura in plastica bianca e trasparente, diffusore composto da elementi di polipropilene finitura oro.

RU · Подвеска для интерьера, структура из белого и прозрачного пластика, абажур из золотых полипропиленовых элементов.

HU · Beltéri függeszték, fehér és átlátszó műanyag szerkezete, arany polipropilén elemek lámpavédelme.

BG · Окачване за интериор, структура от бяла и прозрачна пластмаса, абажур от златни полипропиленови елементи.

SK · Závesné interiérové svetidlo, konštrukcia z bieleho a priehľadného plastu, tienidlo zo zlatých polypropylénových prvkov.



INFO/DIMENSIONS

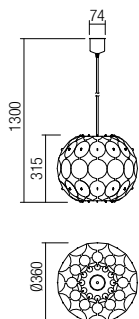

01-1508

E27, 1 x max. 42W



01-1508



01-1508



Tabby



Table lamps for interior, double diffuser of clear acrylic and frosted acrylic, metal base available in mat white, mat black or red copper. Equipped with USB charging port and touch dimmer switch.

RO · Veioze pentru interior, dispersor dublu din acril transparent și acril satinat, bază din metal disponibilă în alb mat, negru mat sau roșu cupru. Echipate cu port de încărcare USB și cu comutator pentru dimare.

IT · Lampade da tavolo per interni, doppio diffusore in acrilico trasparente e acrilico satinato, base in metallo disponibile nei colori bianco opaco, nero opaco o rosso rame. Dotate di porta di ricarica USB e interruttore dimmer tattile.

RU · Настольные лампы для интерьера с двойным рассеивателем из прозрачного акрила и матового акрила, металлическая основа из матового белого, матового черного или цвета меди. Оснащены USB-портом для зарядки и сенсорным диммером.

HU · Beltéri asztali lámpák, dupla diszperzórral: áttetsző akril és matt akril difúzor, matt fehér, matt fekete vagy vörös réz szerkezet. Dimmerrel és USB porttal ellátva.

BG · Интериорни настолни осветителни тела, двоен дифузер от прозрачно акрил и заскрежен акрил, корпус от метал в бял мат, черен мат ИЛИ червен мед. Окомплектовани с USB порт за зареждане и димер с докосване.

SK · Interiérové stolové lampy, dvojitý difúzor z číreho akrylu a matného akrylu, kovová základňa v matnej bielej, matnej čiernej alebo červenej medenej farbe. Lampy sú vybavené USB nabíjacím portom a dotykovým spínačom.





01-1747



01-1748



01-1749

1° TOUCH LIGHT ON / 1° STEP LIGHT DIMMER



2° TOUCH 2° STEP LIGHT DIMMER



3° TOUCH 3° STEP LIGHT DIMMER



4° TOUCH LIGHT OFF



INFO/DIMENSIONS

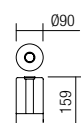

○ 01-1747 Mat White

● 01-1748 Red Copper

● 01-1749 Mat Black

SMD LED · 2,5W · 3000K · CRI 80

LED flux 239 lm

Luminaire flux 148 lm



Wiggle



Series of interior light fittings, equipped with SMD LEDs, available in different colors: white, blue or black. Housing of polycarbonate, ABS and silicone, diffuser of satin polycarbonate.

RO - Serie de corpuri de iluminat, echipate cu LED-uri SMD, disponibile în mai multe variante de culori: alb, albastru sau negru. Structură din policarbonat, ABS și silicon, dispersor din policarbonat satinat.

IT - Serie di apparecchi per interni, equipaggiate con LED SMD, disponibili nelle varianti colore: bianco, blu oppure nero. Struttura in policarbonato, ABS e silicone, diffusore in policarbonato satinato.

RU - Серия светильников для внутреннего освещения, оснащенный светодиодами SMD, в некоторых вариантах цветового исполнения: белого, синего или чёрного цвета. Конструкция из поликарбоната, АБС и силикона, диффузор из сатирированного поликарбоната.

HU - Beltéri világítótétest sor, SMD LED-ekkel ellátva, többféle színváltozatban (fehér, kék, fekete) kapható polikarbonát, ABS és szilikon szerkezettel, szatinált polikarbonát diszperzórral.

BG - Серия интериорни осветителни тела, оборудвана с LED-ове SMD, налична в няколко цветови варианта: бял, син или черен. Структура от поликарбонат, ABS и силикон, разсейвател от сатениран поликарбонат.

SK - Rad interiérových svietidiel vybavená SMD LED diódami, k dispozícii v rôznych farbách: biela, modrá alebo čierna. Puzdro z polykarbonátu, ABS a silikónu, difúzér zo saténového polykarbonátu.

INFO/DIMENSIONS

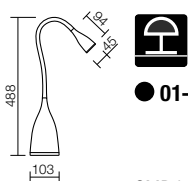

● 01-1051 Black

SMD LED · 5,5W · 3000K · CRI 82
LED flux 632 lm
Luminaire flux 430 lm

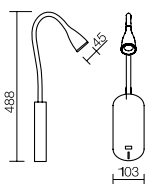

○ 01-1097 White

● 01-1098 Black

SMD LED · 5W · 3000K · CRI 82

LED flux 580 lm

Luminaire flux 410 lm



01-1097



01-1098

USB
PORT



01-1051



01-1098

Bobo



Indoor table lamp, equipped with SMD LEDs and switch on the power supply cable, housing and diffuser of opal polycarbonate.

RO · Veioză pentru interior, echipată cu LED-uri SMD și întrerupător pe fir, structură și dispersor din policarbonat opal.

IT · Lampada da tavolo per interni, equipaggiata a LED SMD e interruttore a filo, struttura e diffusore in policarbonato opalino.

RU · Ночник для внутреннего освещения, оснащенный светодиодами SMD и проводным переключателем, конструкция и диффузор из опалового поликарбоната.

HU · Beltéri olvasólámpa, SMD LED-ekkel és huzalkapcsolóval ellátva, opál polikarbonát szerkezettel és diszperzórral.

BG · Интериорна нощна лампа, оборудвана с LED-ове SMD и кабелен превключвател, структура и разсейвател от поликарбонат опал.

SK · Interiérová stolná lampa vybavená SMD LED diódami a privodným káblom s vypínačom, telo a difúzor z opálového polykarbonátu.

INFO/DIMENSIONS



01-1042

SMD LED · 2,5W · 3000K · CRI 82

LED flux 312 lm

Luminaire flux 220 lm



Irudo



Lighting fixtures for interior equipped with SMD LEDs, structure in aluminum and metal electrostatically painted in sand white, diffuser of opal white PVC.

RO - Corpuri de iluminat pentru interior echipate cu LED-uri SMD, structură din aluminiu și metal vopsită în câmp electrostatic alb mat, dispersor din PVC alb opal.

IT - Apparecchi per interni equipaggiati con SMD LED, struttura in alluminio e metallo verniciati a polveri bianco opaco, diffusore in PVC opalino bianco.

RU - Светильники для интерьера, оснащенные светодиодами SMD, структура из алюминия и металла окрашена в электростатическом поле в матово-белый цвет, рассеиватель из опалового ПВХ белого цвета.

HU - SMD LED-ekkel felszerelt beltéri világítótestek, alumínium és elektrosztatikus mezőben matt fehérre festett fém struktúrával, opál fehér PVC fényszóróval.

BG - Осветителни тела за интериор, осветление, оборудвани със SMD светодиоди, структура от алуминий и метал боядисана в электростатично поле в цвят матово бяло, дифузер от бял опалов PVC.

SK - Svietidlá do interiéru osadené SMD LED diódami, štruktúra z hliníka a kovu lakovaná pieskovou bielou, difúzor z opálového bieleho PVC.



01-2347

INFO/DIMENSIONS

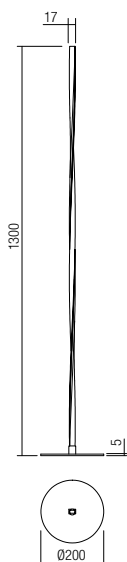

01-2348

SMD LED · 19W · 4000K · CRI 80
LED flux 1950 lm
Luminaire flux 1083 lm

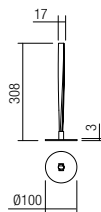

01-2347

SMD LED · 6W · 4000K · CRI 80
LED flux 480 lm
Luminaire flux 298 lm



01-2348





01-2348



Table lamps for indoor, metal structure painted in mat white or mat black or anodized in mat gold or mat copper, fitted with touch switch.

RO · Veioze pentru interior, structură din metal vopsit în alb mat sau negru mat ori anodizat aur mat sau cupru mat. Prevazute cu întrerupător cu atingere.

IT · Lampade da tavolo per interni, struttura in metallo verniciato bianco opaco o nero opaco oppure anodizzato oro opaco o rame opaco. Dotate di interruttore tattile.

RU · Настольные лампы для интерьера, металлическая конструкция, окрашенная в матовый белый или матовый черный или анодированна под матовое золото или матовую медь, оснащены сенсорным выключателем.

HU · Beltéri asztali lámpa, matt fehér vagy matt fekete fém szerkezet vagy eloxált matt arany, matt réz. Érintőkapcsolóval ellátva.

BG · Лампи за интериор, метална структура боядисана в цвят матово бяло или матово черно или анодизирано матово златно или матов мед. Разполагат с тъч превключвател.

SK · Stolové lampy do interiéru, kovová konštrukcia lakovaná matnou bielou alebo matnou čiernou alebo eloxovaná z matného zlata alebo matnej medi, vybavené dotykovým spínačom.

TOUCH SWITCH



01-2130

INFO/DIMENSIONS

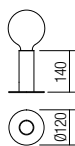

- 01-2129 Sand White
- 01-2130 Anodised Gold
- 01-2131 Anodised Copper
- 01-2132 Sand Black

E27, 1 x max. 42W



01-2129

01-2130

01-2131

01-2132

Shadow



Table lamps for interior, metal structure and fretted metal diffuser painted in white, grey, black or with copper finish.

RO · Veioze pentru interior, structură din metal cu dispersor din metal traforat vopsite alb, gri, negru sau finisate cupru.

IT · Lampade da tavolo per interni, struttura metallica e diffusore in metallo traforato verniciati in bianco, grigio, nero o con finitura rame.

RU · Настольные лампы для интерьера с металлической структурой и рассеивателем из из перфорированного металла, окрашенные в белый, серый, черный или медный цвет.

HU · Beltéri asztali lámpa, fehér, szürke, fekete vagy réz perforált fém szerkezet.

BG · Лампи за интериор, метална структура с дифузер от перфорирани метал, боядисани в бяло, сиво, черно или с медово покритие.

SK · Stolové lampy do interiéru, kovová konštrukcia a kovové difúzory lakované bielou, šedou, čiernou alebo medenou farbou.



01-2119



01-2120



01-2121



01-2122

INFO/DIMENSIONS



- 01-2119 White
- 01-2120 Copper
- 01-2121 Grey
- 01-2122 Black

E14, 1 x max. 28W



01-2120



Table lamp for interior, metal and ceramic structure silver with bronze patina, brown fabric shade.

RO · Veioză pentru interior, structură din metal și ceramică finisată argintiu cu patină bronz, abajur textil maro.

IT · Lampada da tavolo per interni, struttura in metallo e ceramica finitura argento patinato bronzo, paralume in tessile marone.

RU · Настольная лампа для интерьера, структура из серебристого металла и керамики с бронзовой патиной, текстильный абажур коричневого цвета.

HU · Beltéri asztali lámpa, ezüst fémszerkezet és antikolt bronz kerámia, barna textil ernyő.

BG · Лампа за интериор, метална и керамична сребърна структура, с бронзова патина, текстилен кафяв абажур.

SK · Stolová interiérová lampa, štruktúra z kovu a keramiky v striebornej a bronzovej patine, hnedé textilné tienidlo.

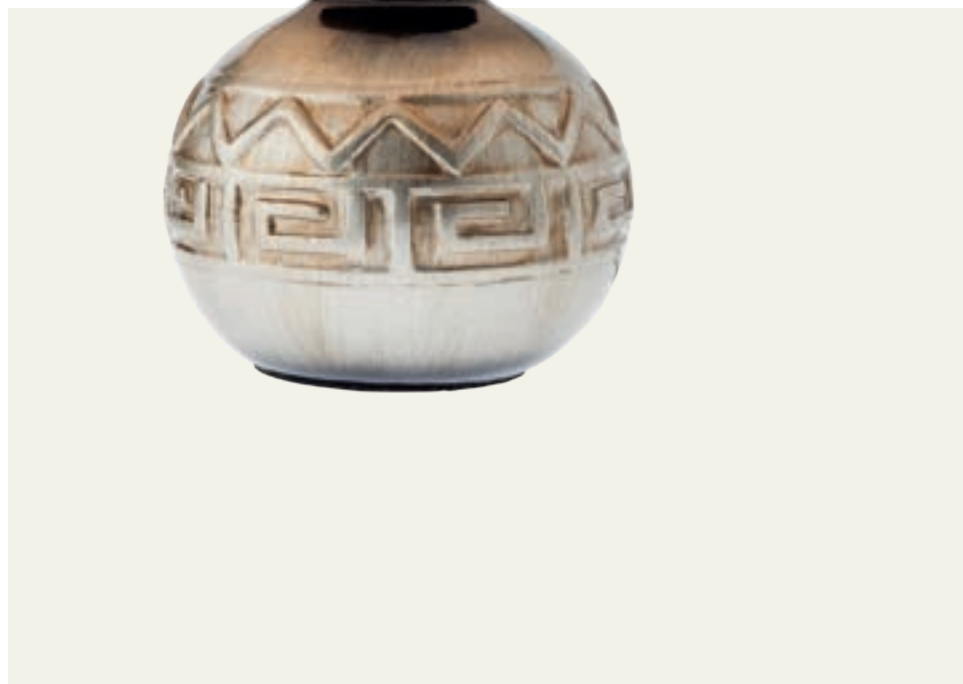

INFO/DIMENSIONS

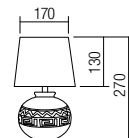

01-2128

E27, 1 x max. 42W



Lua



Table lamps for interior available in two versions: silver finish ceramic structure with white fabric shade or gold finish ceramic structure with black fabric shade.

RO · Veioze pentru interior disponibile în două variante: structură din ceramică finisată argintiu cu abajur textil alb sau structură din ceramică finisată auriu cu abajur textil negru.

IT · Lampade da tavolo per interni disponibili in due versioni: struttura in ceramica finitura argento con paralume in tessuto bianco o struttura in ceramica finitura oro con paralume in tessuto nero.

RU · Настольные лампы для интерьера доступны в двух вариантах отделки: керамическая структура с серебряной отделкой и белым тканевым абажуром или керамическая структура с золотой отделкой и черным тканевым абажуром.

HU · Beltéri asztali lámpák kétféle kivitelben: ezüst kerámia szerkezet és fehér textil ernyő vagy arany kerámia szerkezet és fekete textil ernyő.

BG · Интериорни настолни осветителни тела в два варианта на покритие – корпус от керамика в цвят сребро и бяла фабрична шапка или керамичен корпус с цвят злато и черна фабрична шапка.

SK · Interiérové stolové lampy, dostupné v dvoch prevedeniach: strieborná keramická štruktúra s bielym textilným tienidlom, alebo zlatá keramická štruktúra s čiernym textilným tienidlom.



01-1838



01-1835

INFO/DIMENSIONS

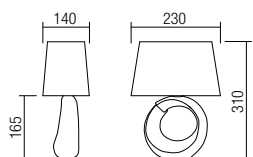

● 01-1835 Silver
● 01-1836 Gold

E14, 1 x max. 28W

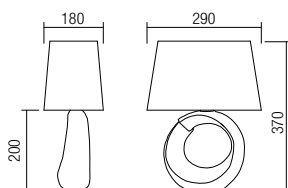

● 01-1837 Silver
● 01-1838 Gold

E27, 1 x max. 42W



Five



Series of table lamps, housing of enameled ceramics and shade of textile material, available in different color versions.

RO · Serie de veioze pentru interior, corp din ceramică smălțuită și abajur textil, disponibile în mai multe variante de culori.

IT · Serie di lampade da tavolo, corpo in ceramica smaltata e paralume tessile, disponibile in diverse varianti colore.

RU · Серия настольных ламп для внутреннего освещения, корпус глазурованной керамики и текстильный абажур, производственных в некоторых вариантах цветового исполнения.

HU · Beltéri éjjeli lámpák sorozata, zománcozott kerámia test és szövet lámpaernyő, mely több színárnyalatban kapható.

BG · Серия интериорни нощни лампи, тяло от емайлирана керамика, абажур от плат, налични в няколко цветови варианта.

SK · Sériá stolových l&acaron;p, telo zo smaltovanej keramiky a tienidla z textilného materiálu, k dispozícii v rôznych verziách farieb.



01-854

01-855

01-856



01-857

01-858

INFO/DIMENSIONS

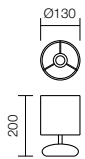

- 01-854 White
- 01-855 Red
- 01-856 Purple
- 01-857 Brown
- 01-858 Grey

E14, 1 x max. 28W



01-856

Cilly

Series of table lamps, housing of glazed ceramics and shade of white, light grey or beige textile.

RO · Serie de veioze pentru interior, corp din ceramică smălțuită și abajur textil culoare albă, gri deschis sau bej.

IT · Serie di lampade da tavolo, corpo in ceramica smaltata, paralume tessile bianco, grigio chiaro o beige.

RU · Серия настольных ламп для интерьера, корпус из глазурированной керамики и абажур из текстиля белого, серого или бежевого цвета.

HU · Beltéri asztali lámpák, zománcozott lámpatest, fehér, szürke vagy bézs textil lámpaernyő.

BG · Серия настольни лампи, корпус от глацирана керамика и абажур от бял, светло сив или бежов текстил.

SK · Sériá stolových lúč z glazovanej keramiky s textilným tienidlom v bielej, šedej a béžovej farbe.



INFO/DIMENSIONS

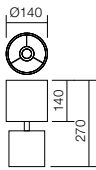

- 01-1370 White
- 01-1371 Light Grey
- 01-1372 Beige

E14, 1 x max. 28W



01-1370



01-1371



01-1372



01-1371

01-1840



Table lamps for interior, structure of wood and white painted metal, shade of white or grey fabric and wire switch.

RO · Veioze pentru interior, structură din lemn și metal vopsit alb, abajur din țesătură albă sau gri și întrerupător pe cablu.

IT · Lampada da tavolo per interni, struttura in legno e metallo verniciato bianco, paralume in tessuto bianco o grigio, interruttore a cavo.

RU · Настольные лампы для интерьера, структура из дерева и окрашенного в белый цвет металла, абажур из белой или серой ткани и выключатель на кабеле.

HU · Beltéri asztali lámpa, fehér fa és fém szerkezet, fehér vagy szürke szövet ernyő, átmenő kapcsolóval.

BG · Лампи за интериор, дървена и метална структура боядисана в бяло, бял или сив текстилен абажур и превключвател на кабела.

SK · Stolové lampy do interiéru, štruktúra dreva a bieleho kovu, odtieň bielej alebo sivej látky, vybavené spínačmi.



01-2123



01-2124

INFO/DIMENSIONS

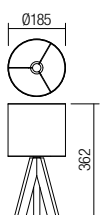

○ 01-2123 White

● 01-2124 Grey

E27, 1 x max. 42W



230V
50Hz

Home



Series of table lamps, housing of glazed ceramics and shade of beige or brown textile.

RO · Serie de veioze pentru interior, corp din ceramică smălțuită și abajur textil culoare bej sau maro.

IT · Serie di lampade da tavolo, corpo in ceramica smaltata, paralume tessile avorio o marrone.

RU · Серия настольных ламп для интерьера, корпус из глазурированной керамики и абажур из текстиля бежевого или коричневого цвета.

HU · Beltéri asztali lámpák, zománcozott lámpatest, bézs vagy bana szövet lámpaernyő.

BG · Серия настольни лампи, корпус от гланцирана керамика и абажур от бежов или кафяв текстил.

SK · Sériu stolových l amp z glazovanej keramiky s textiln ym tienidlom v b ezovej alebo hnedej farbe.



01-1374



01-1373

INFO/DIMENSIONS

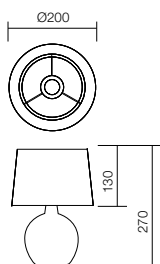

○ 01-1373 Beige

● 01-1374 Brown

E14, 1 x max. 28W



Sella

Table lamp for interior, structure of wood and white painted metal, shade of beige fabric and wire switch.

RO · Veioză pentru interior, structură din lemn și metal vopsit alb, abajur din țesătură bej și întrerupător pe cablu.

IT · Lampada da tavolo per interni, struttura in legno e metallo verniciato bianco, paralume in tessuto avorio e interruttore a cavo.

RU · Настольная лампа для интерьера, корпус из дерева и металла крашенного в белый цвет, абажур из бежевой ткани и выключатель на шнуре.

HU · Beltéri asztali lámpa, fából és fehér fém lámpatest, bézs szövet ernyő, átmenő kapcsolós vezetékkel.

BG · Интериорна настолна лампа, структура от дърво и боядисан в бяло метал, шапка от бежова тъкан и кабел с ключ.

SK · Stolová lampa, štruktúra z dreva a bieleho lakovaného kovu, textilné tienidlo v béžovej farbe.



INFO/DIMENSIONS



01-2127

E14, 1 x max. 28W



Four



Table lamp for interior, structure of wood and white painted metal, shade of beige fabric and wire switch.

RO · Veioză pentru interior, structură din lemn și metal vopsit alb, abajur din țesătură bej și întrerupător pe cablu.

IT · Lampada da tavolo per interni, struttura in legno e metallo verniciato bianco, paralume in tessuto avorio e interruttore a cavo.

RU · Настольная лампа для интерьера, корпус из дерева и металла крашенного в белый цвет, абажур из бежевой ткани и выключатель на шнуре.

HU · Beltéri asztali lámpa, fa és fehér fém lámpatest, bézs szövet lámpaernyő, átmanő kapcsolóval ellátva.

BG · Настолни интериорни лампи, арматура от дърво и боядисан в бяло метал, абажур от бежов плат и ключ.

SK · Stolová interiérová lampa, štruktúra z dreva a bieleho lakovaného kovu, textilné béžové tienidlo.



INFO/DIMENSIONS

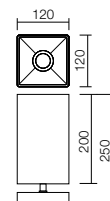

01-1375

E14, 1 x max. 28W



Inge

Light fittings for interior, bamboo structure and white polypropylene shade.

RO · Corpuri de iluminat pentru interior, structură din lemn de bambus și abajur din polipropilenă albă.

IT · Apparecchi di illuminazione per interni, struttura in bambù e paralume in polipropilene bianco.

RU · Светильники для интерьера, бамбуковая структура и белый полипропиленовый плафон.

HU · Beltéri lámpák, bambusz fa szerkezet és fehér polipropilén ernyő.

BG · Интериорни осветителни тела, корпус от бамбук и бяла шапка от полипропилен.

SK · Svetidlá pre interiér, bambusová štruktúra a biele polypropylénové tienidlo.



01-1841



01-1842



01-1843

INFO/DIMENSIONS

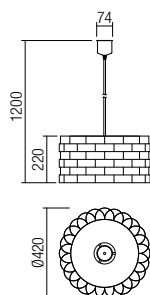

01-1841

E27, 1 x max. 42W

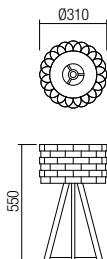

01-1842

E27, 1 x max. 28W

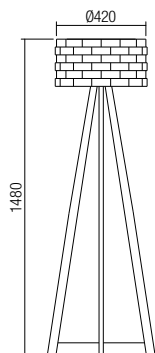
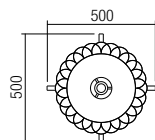

01-1843

E27, 1 x max. 42W





01-1843

Glenn



Floor lamp for interior, metal structure electrostatically painted in two versions: black with chromed elements, provided with wooden shelf in walnut finishing and shade of beige fabric or white with chromed elements, provided with wooden shelf in oak finishing and shade of white fabric, with pull wire switch.

RO · Lampadar pentru interior, structură din metal vopsit în câmp electrostatic disponibil în două versiuni: negru cu elemente cromate, prevăzut cu poliță din lemn finisaj nuc și abajur din țesătură bej sau alb cu elemente cromate, prevăzut cu poliță din lemn finisaj stejar deschis și abajur din țesătură albă, cu întrerupător cu fir.

IT · Piantana per interni, struttura in metallo verniciato a polveri disponibile in due versioni di finitura: nera e dettagli cromati con mensola in legno finitura noce, paralume in tessuto avorio o bianca e dettagli cromati con mensola in legno finitura rovere, paralume in tessuto bianco, con interruttore con filo.

RU · Торшер для интерьера, структура из металла окрашенного в электростатическом поле, возможен в двух вариантах: черный с хромированными элементами, предусмотрена деревянная полка отделанная под орех и абажур из бежевой или белой ткани с хромированными элементами или белый с хромированными элементами, предусмотрена деревянная полка отделанная под светлый дуб, абажур из белой ткани и выключатель на шнуре.

HU · Beltéri álló lámpa, elektrosztatikus mezőben fehérre festett fémrész króm elemekkel, világos tölgy fa berakással, fehér szövet ernyő, átmenő kapcsolóval szerelve.

BG · Интериорен лампион, метална сруктура, електростатично боядисана в два варианта: черно с хромирани елементи, снабдена с полица от дърво облицовка от орех и бежова или бяла текстилна шапка с хромирани елементи или полица от дърво облицовка от дъб, бяла текстилна шапка и въженце.

SK · Stojanová interiérová lampa, kovová štruktúra lakovaná v dvoch verziách: čierna s chrómovými prvkami v prevedení drevo-orech, tienidlo v béžovej farbe alebo biela s chrómovými prvkami v prevedení drevo-dub, tienidlo v bielej farbe s vypínačom na kábli.

INFO/DIMENSIONS

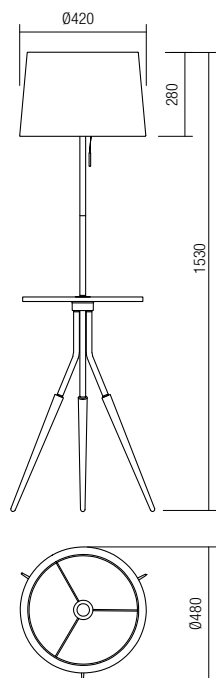

● 01-1464 Black

○ 01-1468 White

E27, 1 x max. 42W



01-1468





VINTAGE

Larry



Series of light fixtures for interior, metal structure electrostatically painted in mat black with antique brass details and champagne, copper or smoky blown glass diffuser.

RO · Serie de corpuri pentru interior, structură din metal vopsit în câmp electrostatic negru mat cu detalii finisate alamă antichizată, dispensor din sticlă suflată champagne, cuprată sau fumurie.

IT · Serie di apparecchi per interni, struttura in metallo verniciato a polveri nero opaco con dettagli finitura ottone anticato, diffusore in vetro soffiato champagne, ramato o fumè.

RU · Серия светильников для интерьера, структура из металла окрашенного в электростатическом поле в черный матовый цвет с элементами отделанными под старинную латунь, рассеиватель из медненного стекла, цвета шампанского или дымчатого.

HU · Beltéri mozgatható karú világítótestek, elektrosztatikus mezőben festett matt fekete fémszerkezet antik réz betéttel, fúvott pezsgő üveggel.

BG · Серия интериорни осветителни тела, метална структура електростатично боядисана в матово черно с антично месингови детайли и бежов, меден или опушен разсейвател от духано стъкло.

SK · Sériá interiéroových svietidiel, kovová konštrukcia lakovaná v matnej čiernej farbe so starožitnými mosadznými detailami, sklenený difúzor vo farbe champagne, medená alebo dymová.



01-1385

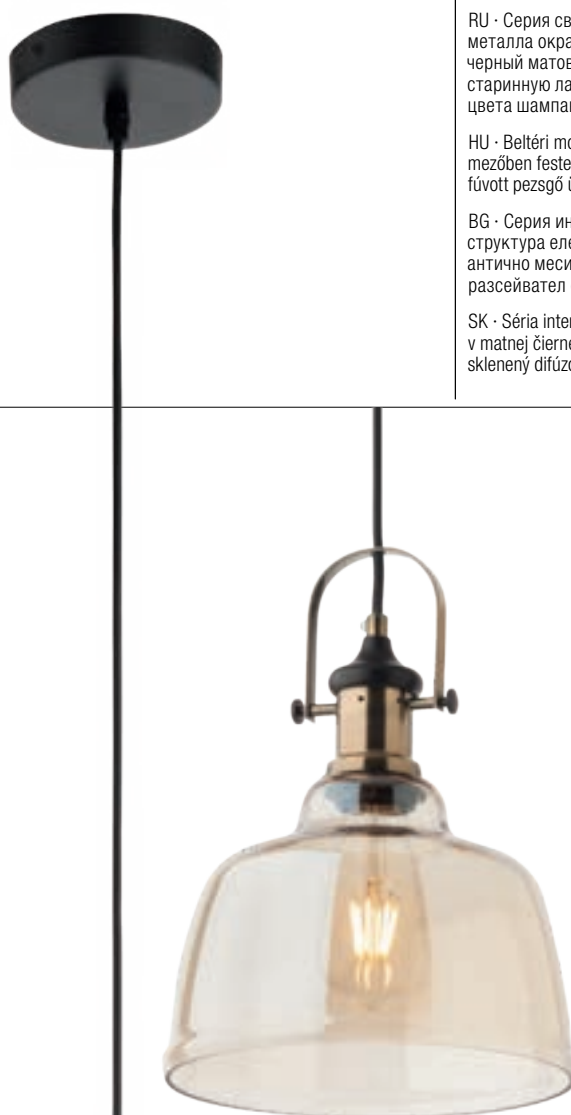

01-1383



01-1384



01-1382



01-1384



01-1381

INFO/DIMENSIONS

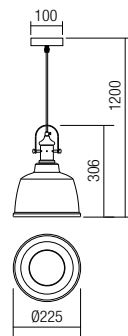
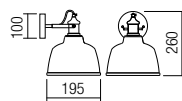

- 01-1380 Champagne
- 01-1381 Copper
- 01-1382 Smoky

E27, 1 x max. 42W



- 01-1383 Champagne
- 01-1384 Copper
- 01-1385 Smoky

E27, 1 x max. 42W



Saville



Series of interior light fittings, metal structure, electrostatically painted in black with antique brass metal elements, amber blown glass diffuser.

RO · Serie de corpuri de iluminat pentru interior, structură din metal vopsit în câmp electrostatic negru cu elemente metalice finisaj bronz antic, dispersor din sticlă suflată ambră.

IT · Serie di apparecchi per interni, struttura in metallo verniciato a polveri nero con particolari in metallo finitura bronzo anticato, diffusore in vetro soffiato ambrà.

RU · Серия подвесок для внутреннего освещения, металлическая конструкция, окрашенная в электростатическом поле чёрного цвета с металлическими элементами с отделочным слоем античного бронза, диффузор из выдувного стекла янтарного цвета.

HU · Beltéri világítótest sor, elektrosztatikus térben feketére festett, antik bronz kikészítésű fémelemekkel ellátott fémszerkezettel, borostyánszínű, fúvottüveg diszperzórral.

BG · Серия интериорни осветителни тела, структура от метал, боядисан в черно електростатично поле с метални елементи, покритие античен бронз, разсейвател от духано кехлибарено стъкло.

SK · Rad interiérových svietidiel, kovová konštrukcia, elektrostaticky lakované v čiernej farbe a so starožitným mosadz kovovými prvkami, oranžové tienidlo z fúkaného skla.



01-1003

01-1003



Saville



01-1002



01-1003



01-1004



INFO/DIMENSIONS

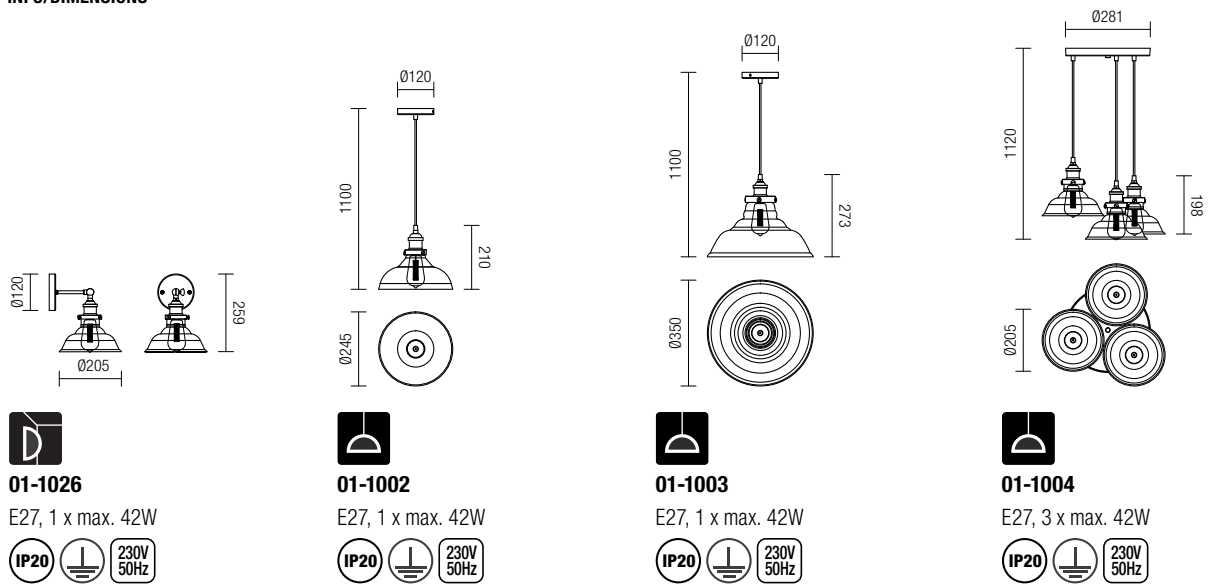



Series of adjustable light fixtures for interior, metal structure electrostatically painted in mat black.

RO · Serie de corpuri orientabile pentru interior, structură din metal vopsit în câmp electrostatic negru mat.

IT · Serie di apparecchi orientabili per interni, struttura in metallo verniciato a polveri nero opaco.

RU · Серия ориентируемых светильников для интерьера, структура из металла окрашенного в электростатическом поле в черный цвет.

HU · Beltéri mozgatható karú világítótestek, elektrosztatikus mezőben festett matt fekete fémszerkezet.

BG · Серия регулируеми интериорни осветителни тела, метална структура електростатично боядисана в матово черно.

SK · Sériá nastaviteľných interiérových svietidiel, kovová konštrukcia lakovaná v matnej čiernej farbe.



01-1388



01-1387

INFO/DIMENSIONS

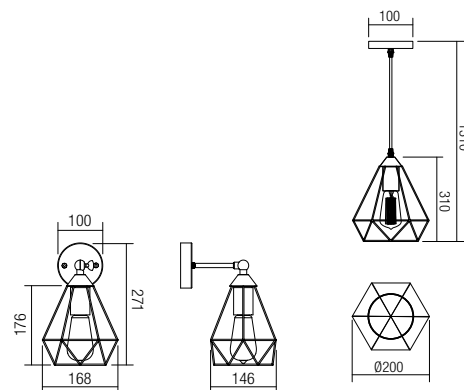
**01-1387**

E27, 1 x max. 42W

**01-1388**

E27, 1 x max. 42W





01-1388



Spinner

Series of interior light fittings, metal structure and diffuser electrostatically painted in mat black/mat white with antique copper/antique gold details or in metal with antique brass finishing.



RO - Serie de corpuri de iluminat pentru interior, structură și dispersor din metal vopsit în câmp electrostatic în versiuni de culoare negru mat/alb mat cu detalii finisate cupru antichizat/aur antichizat sau din metal cu finisaj alamă antichizată.

IT - Serie di apparecchi per interni, struttura e paralume in metallo verniciato a polveri nero opaco/bianco opaco con dettagli finitura rame anticato/oro anticato o in metallo finitura ottone anticato.

RU - Серия светильников для интерьера, металлическая конструкция и рассеиватель, окрашенные в электростатическом поле в матовый черный/матовый белый цвет, с элементами из состаренной меди.

HU - Beltéri világítótestek, elektrosztatikus mezőben festett matt fekete/matt fehér fémszerkezet antikolt réz/antikolt arany betéttel.

BG - Серия интериорни осветителни тела, структура и разсейвател от метал електростатично боядисани в матово черно/матово бяло с антично медни/антично златни детайли или от метал с антично месингово покритие.

SK - Sériá interiérových svietidiel, kovová konštrukcia a difúzor z kovu lakovaná v matnej čiernej/matnej bielej farbe so starožitnými medenými/starožitnými zlatými detailami alebo kovu so starožitným mosadzným povrchom.



01-1290



01-1291



01-1289



01-1292

INFO/DIMENSIONS

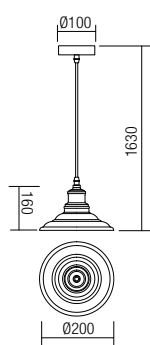
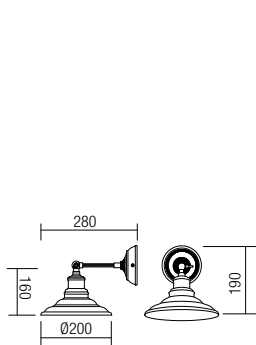

- 01-1289 Mat Black/Copper
- 01-1290 Mat White/Antique Gold
- 01-1291 Antique Brass

E27, 1 x max. 42W



- 01-1292 Mat Black/Copper
- 01-1293 Mat White/Antique Gold
- 01-1294 Antique Brass

E27, 1 x max. 42W



01-1292



01-1294



01-1293



CLASSIC

Giorgia

Collection of suspensions with chromed metal structure, white fabric lampshades and transparent crystal decorations.

RO · Serie de suspensii cu structură din metal cromat, abajururi din țesătură albă și decorațiuni din cristal transparent.

IT · Serie di sospensioni con struttura in metallo cromato, paralumi in tessuto bianco e decorazioni di cristallo trasparente.

RU · Серия подвесок с металлической хромированной структурой, абажуры из белой ткани и украшения из прозрачного хрусталя.

HU · Krómozott fémszerkezetű felfüggesztések sorozata, fehér szövet lámpaernyő és áttetsző kristály díszítőelemek.

BG · Серия полилеи със структура от хромиран метал, абажури от бял плат и украшения от прозрачен кристал.

SK · Kolekcia interiérových zavesných svietidiel so štruktúrou chróm kov, biela látka tienidla a priehľadné krištáľové ozdoby.



02-642



02-643

INFO/DIMENSIONS

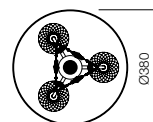
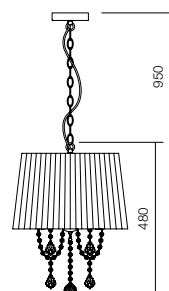

02-642

E14, 3 x max. 28W

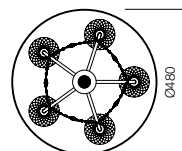
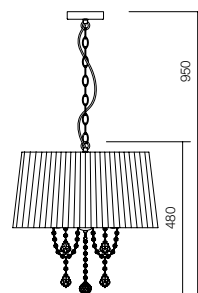

02-643

E14, 5 x max. 28W





02-643



Bolero



Indoor lamps, chrome and acrylate metal structure in transparent or black variants.

RO · Colecție de lămpi pentru interior, structură din metal cromat și acrilat transparent sau negru.

IT · Serie di lampade per interni, struttura in metallo cromato e acrilico nelle varianti trasparente o nero.

RU · Серия ламп для внутреннего освещения, структура из хромированного металла и прозрачного или чёрного акрилата.

HU · Lámpák sorozat belső számára, krómozott vagy akrilozott fém szerkezet, választható szín: átlátszó vagy fekete.

BG · Серия вътрешни лампи, структура от хромиран метал и акрилат във варианти прозрачен или черен.

SK · Interiérové lampy, chróm a akrylová kovová konštrukcia v priehľadnej alebo čiernej variante.



INFO/DIMENSIONS

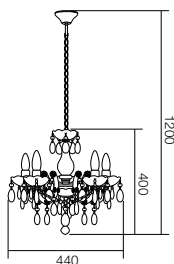
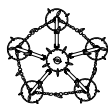

○ 06-006 Transparent

● 06-003 Black

E14, 5 x max. 28W



06-006



06-003



06-004



06-002

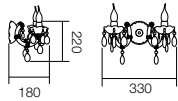
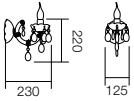

○ 06-004 Transparent

● 06-001 Black

E14, 1 x max. 28W



○ 06-005 Transparent

● 06-002 Black

E14, 2 x max. 28W



Aspera



Series of lighting fixtures for interior, metal structure finished in gunmetal with transparent glass decorations, smoke glass shades

RO · Serie de corpuri de iluminat pentru interior, structură din metal finisată negru țevă de pușcă cu decorațiuni din sticlă transparentă, abajururi din sticlă fumurie.

IT · Serie di apparecchi per interni, struttura in metallo finitura nero lucido canna di fucile, decorazioni in vetro trasparente, paralumi in vetro fumè.

RU · Серия светильников для интерьера, вороненая металлическая конструкция с украшениями из прозрачного стекла, рассеиватели из дымчатого стекла.

HU · Beltéri lámpatestek, fekete sötét króm fémszerkezet, áttetsző üveg díszítéssel, füst színű üveg ernyő.

BG · Серия осветителни тела за интериор, метална структура в цвят черен пушка, със прозрачни стъклени декорации, абажури от опушено стъкло.

SK · Sérija svietidiel do interiéru, kovová konštrukcia s priehľadnými sklenenými dekoráciami, dymové sklenené tienidlá.



02-971



02-969

INFO/DIMENSIONS

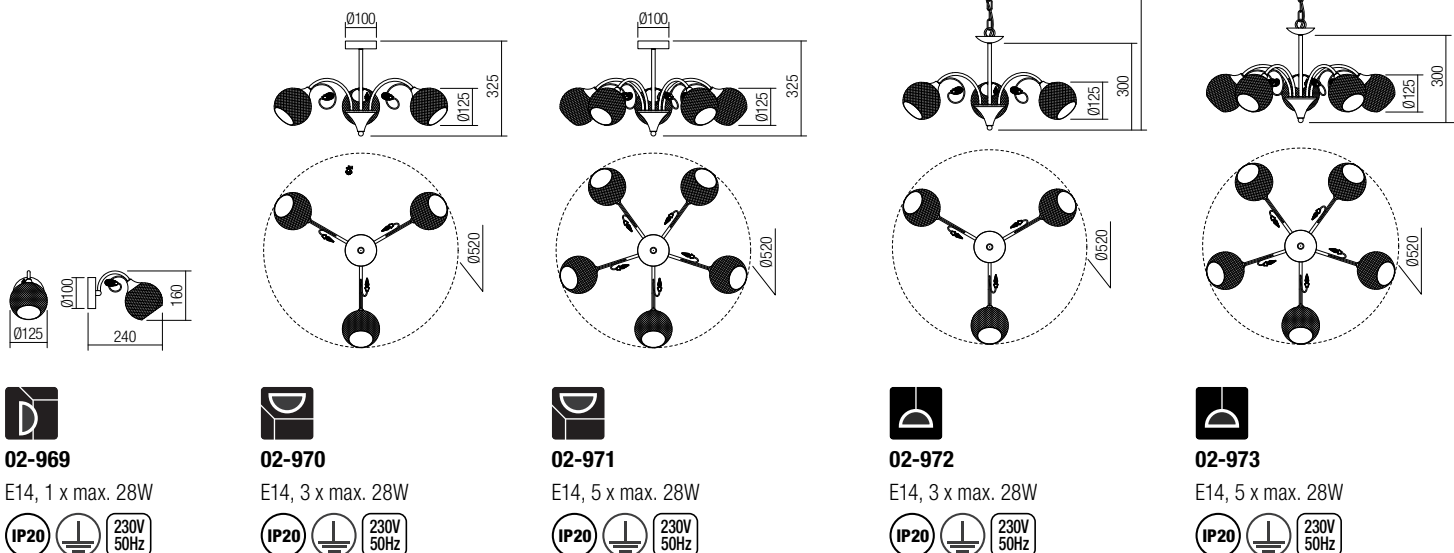



02-973

02-970



02-972

02-971



Lamps for indoor, structure of metal with antique bronze finish, opal glass diffusers.

RO · Lămpi pentru interior, structură din metal finisaj bronz antic, abajururi din sticlă opal.

IT · Serie di apparecchi per interni, struttura in metallo finitura bronzo anticato, paralumi in vetro opalino.

RU · Светильники для внутреннего освещения, металлическая конструкция с отделкой под античную бронзу, рассеиватели из опалового стекла.

HU · Beltéri lámpatestek, antik bronz fém szerkezet, opál üveg ernyő.

BG · Лампи за интериор, метална структура с антично бронзово покритие, абажури от опалово стъкло.

SK · Svetidlá pre interiér, kovová konštrukcia s antickým bronzovým povrchom, difúzory z opalového skla.

INFO/DIMENSIONS

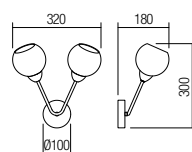

02-974

E27, 2 x max. 42W

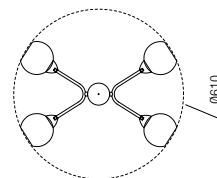
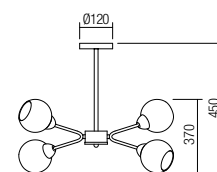

02-975

E27, 4 x max. 42W

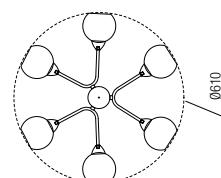
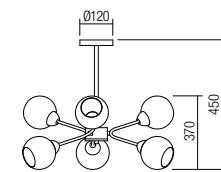

02-976

E27, 6 x max. 42W

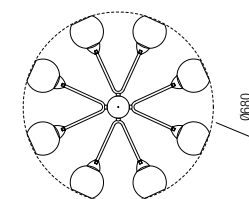
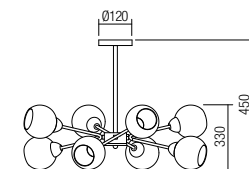

02-977

E27, 8 x max. 42W



02-974



02-975



02-976



02-977



Ceiling lamps for indoor, metal structure with antique brass finishing, amber blown glass lampshades.

RO · Plafoniere pentru interior, structură din metal cu finisaj alamă antică, abajururi din sticlă suflată ambră.

IT · Plafoniere per interni, struttura in metallo finitura ottone anticato, paralumi in vetro soffiato ambrà.

RU · Потолочные светильники для интерьера, структура из металла с отделкой под старую латунь, абажуры из янтарного стекла.

HU · Beltéri mennyezeti lámpák, antikolt réz színű fémszerkezet és borostyán fújt üveg búra.

BG · Интериорни плафониери, метална основа в античен месинг, абажур от кехлибарено стъкло.

SK · Interiérových stropných svietidiel, kovová konštrukcia s povrchovou úpravou z mosadze, jantárové sklenené tienidlo.



02-966

INFO/DIMENSIONS

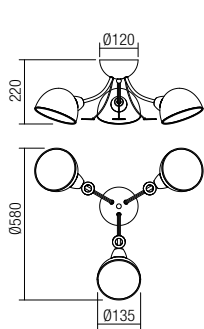
**02-966**

E14, 3 x max. 28W

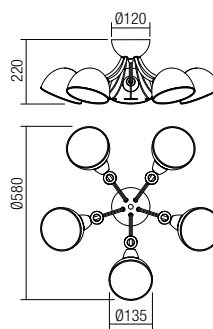
**02-967**

E14, 5 x max. 28W

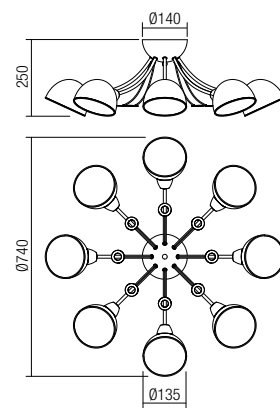
**02-968**

E14, 8 x max. 28W





02-967



02-968



Series of lamps for indoor, metal structure with antique brass finishing, amber blown glass lampshades.

RO · Serie de lămpi pentru interior, structură din metal finisaj alamă antică, abajururi din sticlă suflată ambră.

IT · Serie di apparecchi per interni, struttura in metallo finitura ottone anticato, paralumi in vetro soffiato ambrà.

RU · Серия светильников для интерьера, структура из металла с отделкой под старую латунь, абажуры из янтарного центрифугированного стекла.

HU · Beltéri lámpatestek, antikolt réz színű fémszerkezet és borostyán fújt üveg búra.

BG · Серия от интериорни лампи, метална основа в античен месинг, абажур от кехлибарено стъкло.

SK · Sériá interiérových svietidiel, kovová konštrukcia so starožitným mosadzným povrchom, jantárovo farebné sklo.



02-960



02-961

INFO/DIMENSIONS

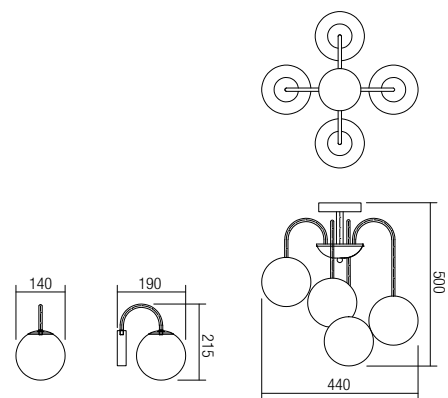

02-960

E14, 1 x max. 28W



02-961

E14, 4 x max. 28W





**Suspension for interior,
metal structure with
antique copper finishing
and painted in black.**

RO · Suspensie pentru interior, structură din metal finisaj cupru antichizat și vopsită negru mat.

IT · Sospensione per interni, struttura in metallo finitura rame anticato e verniciato nero opaco.

RU · Подвесная люстра для интерьера, структура из металла отделанного под старую медь и окрашенного в черный матовый цвет.

HU · Beltéri függesztékek, matt fekete fémszerkezet antik réz betéttel.

BG · Интериорни полилеи, метална структура с антично медно покритие и боядисана в черно.

SK · Závesné interiérové svietidlá, kovová štruktúra lakovaná v čiernej farbe s medennou povrchovou úpravou.



INFO/DIMENSIONS



02-939

E27, 3 x max. 42W

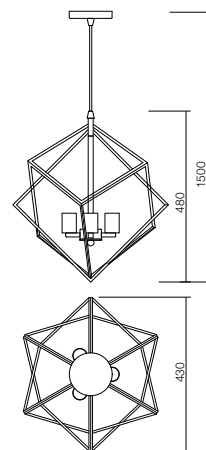

Tiara



Series of indoor lamps with antique bronze metal structure.

RO · Serie de lămpi pentru interior, structură din metal finisat bronz antic.

IT · Serie di lampade per interni, struttura in metallo finitura bronzo antico.

RU · Светильники для внутреннего освещения, металлическая конструкция с отделкой под античную бронзу, рассеиватели из опалового стекла.

HU · Beltéri lámpatestek, antik bronz fémszerkezet.

BG · Лампи за интериор, метална структура с антично бронзово покритие.

SK · Svietidlá pre interiér s antickou bronzovou kovovou konštrukciou.



02-980



02-979



02-978



02-981

INFO/DIMENSIONS

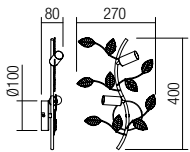

02-978

E14, 2 x max. 28W

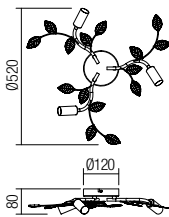

02-979

E14, 3 x max. 28W

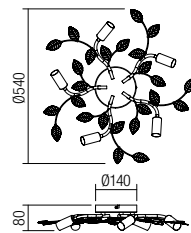

02-980

E14, 5 x max. 28W

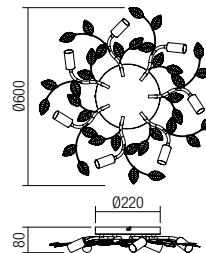

02-981

E14, 7 x max. 28W



Fabiola



Collection of indoor lamps, metal structure in antique brass finishing and transparent glass decorations.

RO - Colecție de lămpi pentru interior, structură din metal finisat alamă antică și decorațiuni din sticlă transparentă.

IT - Collezione di lampade per interni, struttura in metallo finitura ottone anticato e decorazioni in vetro trasparente.

RU - Коллекция ламп для внутреннего освещения с металлической структурой с отделочным слоем античной латуни, украшения из прозрачного стекла.

HU - Beltéri lámpakollekció, antik sárgaréz kivitelezésű fémszerkezet, áttetsző üveg díszítőelemek.

BG - Колекция от интериорни лампи, структура от метал с покритие в античен месинг и украшения от прозрачно стъкло.

SK - Kolekcia interiérových svietidiel, povrchová úprava kov a stará mosadzná štruktúra, transparentné sklenené ozdoby.



02-711



02-712

Fabiola



02-709



02-710

INFO/DIMENSIONS

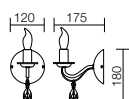

02-709

E14, 1 x max. 28W

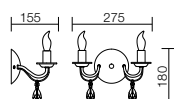

02-710

E14, 2 x max. 28W

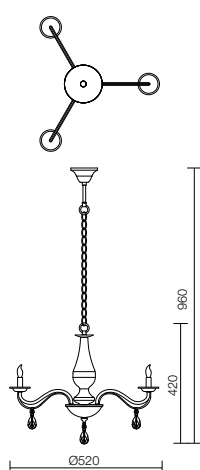

02-711

E14, 3 x max. 28W

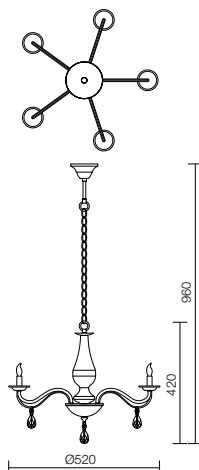

02-712

E14, 5 x max. 28W

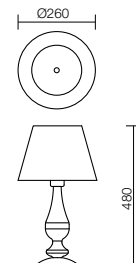

02-713

E27, 1 x max. 42W

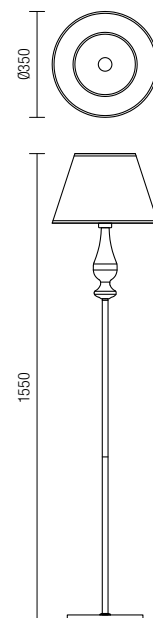

02-714

E27, 1 x max. 42W



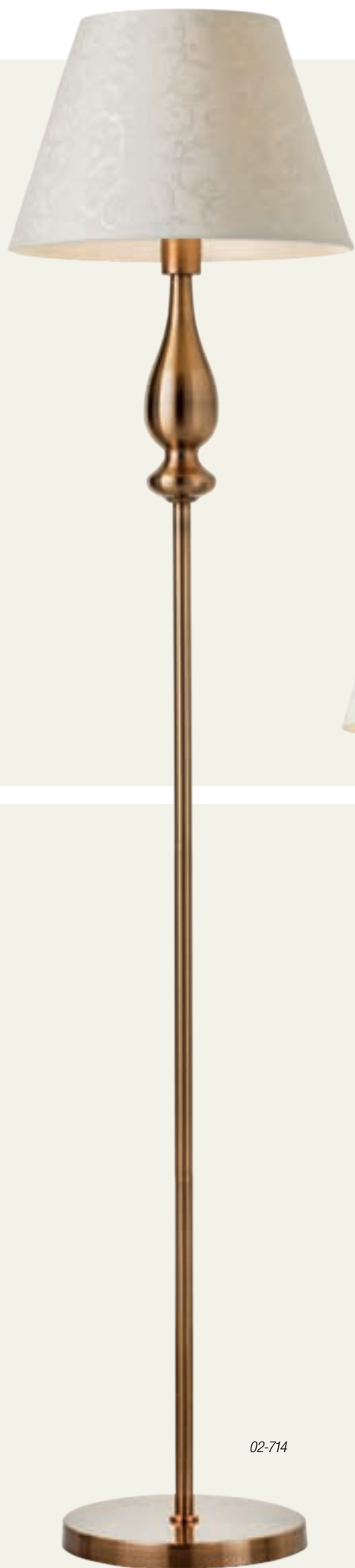

02-714



02-713

Cairo



Wall lamp for interior, metal structure in antique brass finishing or ivory with gold patina. It is projected for illumination of paintings and mirrors.

RO · Aplică pentru interior, structură din metal, în variante de finisaj alamă antică sau ivoar cu patină aur. Proiectată pentru iluminarea tablourilor sau a oglinzilor.

IT · Applique per interni, struttura in metallo, disponibile con finitura ottone antico o avorio patinato oro. Progettata per l'illuminazione di quadri e specchi.

RU · Бра для внутреннего освещения, металлическая структура в вариантах исполнения отделочного слоя античной латуни или цвета слоновой кости с золотой патиной. Разработан для освещения картин или зеркал.

HU · Beltéri falilámpa, antik bronz vagy arannyal patinált, elefántcsont kikészítésű fémszerkezettel. Festmények vagy tükörök megvilágítására szolgál.

BG · Интериорен аплик, метална структура, във варианти с покритие от античен месинг или слонова кост със златна патина. Проектиран за осветяване на картини или огледала.

SK · Nástenné svietidlo pre interiér, kovová konštrukcia, vo variantoch antickej mosadze alebo zo slonoviny so zlatou patinou. Pre osvetlenie obrazov a zrkadiel.



02-845

02-844

INFO/DIMENSIONS

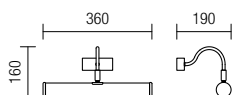

● 02-844 Ivory
● 02-845 Antique Brass

E14, 2 x max. 28W



02-844



Verner



Series of interior light fixtures, metal structure and diffusers electrostatically painted in mat brown with antique brass detail.

RO · Serie de corpuri de iluminat pentru interior, structură și dispersoare din metal vopsit în câmp electrostatic maro mat cu detalii finisat alamă antichizată.

IT · Serie di apparecchi per interni, struttura e paralumi in metallo verniciato a polveri marrone opaco, dettaglio finitura ottone anticato.

RU · Серия светильников для интерьера, структура и рассеиватели из металла окрашенного в электростатическом поле в коричневый цвет с элементом отделанным под старую латунь.

HU · Beltéri álló lámpa, elektrosztatikus mezőben festett matt barna fémszerkezet, antik réz betéttel.

BG · Серия интериорни осветителни тела, метална структура и разсейвател електростатично боядисани в матово кафяво с антично месингови детайли.

SK · Sériu interiérových svietidiel, kovová štruktúra a difúzory lakovaná v matnej hnedej farbe so starožitnými mosadznými detailami.



02-934



02-937

Verner



02-935



02-936



02-937

INFO/DIMENSIONS

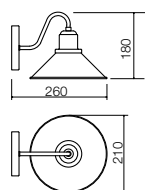

02-934

E27, 1 x max. 42W

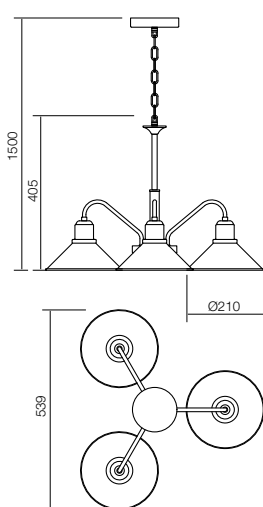

02-935

E27, 3 x max. 42W

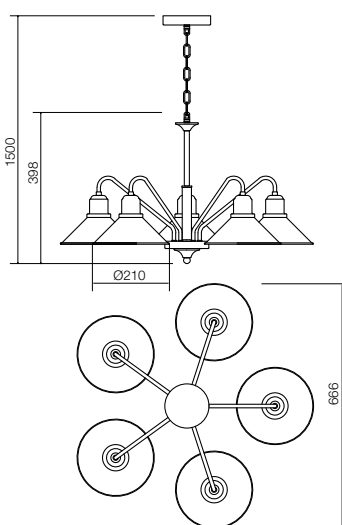

02-936

E27, 5 x max. 42W

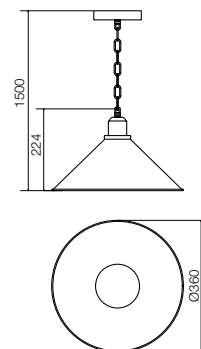

02-937

E27, 1 x max. 42W





WALL & CEILING

Stratos



Series of light fixtures for indoor equipped with SMD LEDs, metal structure painted in mat white, satin acrylic diffusers. The fixtures are delivered with remote control (2 AAA batteries included) with multiple functions: ON/OFF, 3 operating programs, light intensity regulation, variation of the color temperature from warm white to cool white, timer and night light mode.



RO - Serie de corpuri de iluminat pentru interior echipate cu led-uri SMD, structură din metal vopsit alb mat, dispersor din acril satinat. Sunt livrate cu telecomandă (cu 2 baterii AAA incluse) cu următoarele funcții: ON/OFF, 3 programe de funcționare, reglarea intensității luminoase, setarea temperaturii de culoare a luminii de la alb cald la alb rece, timer și mod lumină veghe.

IT - Serie di apparecchi per interni equipaggiati con LED SMD, struttura in metallo verniciato bianco opaco, diffusori in acrilico satinato. Forniti con telecomando (2 batterie AAA incluse) con molteplici funzioni: ON/OFF, 3 programmi operativi, regolazione dell'intensità della luce, variazione della temperatura del colore da bianco caldo a bianco freddo, timer e modalità luce notturna.

RU - Серия светильников для внутреннего освещения, оснащенных светодиодами SMD, металлическая структура, окрашенная в матовый белый цвет, рассеиватели из сатинового акрила. Светильники поставляются с пультом дистанционного управления (2 батарейки AAA входят в комплект) с несколькими функциями: ВКЛ / ВЫКЛ, 3 рабочие программы, регулировка интенсивности света, изменение цветовой температуры от теплого белого до холодного белого, таймер и режим ночного освещения.

HU - Beltéri világítótetek, SMD LED-el ellátva, matt fehér fémszerkezet, szatin akril diszperzör. Távirányítóval van ellátva (2db. AAA elem tartozék), a következőkkel: ON/OFF, fényerősség, színhőmérséklet, meleg-től hideg-ig, időzítő.

BG - Интериорни осветителни тела с SMD LED платка, метален корпус в бял мат, матов акрилен дифузер. Доставка се с дистанционно (батерии 2 AAA са включени) с различни функции: включване/изключване, 3 оперативни програми, регулиране интензитета на светлината, промяна на цветната температура от топло към студено бяло, таймер и нощен режим.

SK - Sériá interiérových svietidiel vybavených LED diódami SMD, kovová štruktúra lakovaná v matnej bielej farbe, saténové akrylové difúzéry. Svetidlá sa dodávajú s diaľkovým ovládaním (2 batérie AAA sú súčasťou dodávky) s viacerými funkciami: ZAP/VYP, 3 operačné programy, regulácia intenzity osvetlenia, zmena teploty farby od teplej bielej po studenú bielu, režim časovača a nočné svetlo.

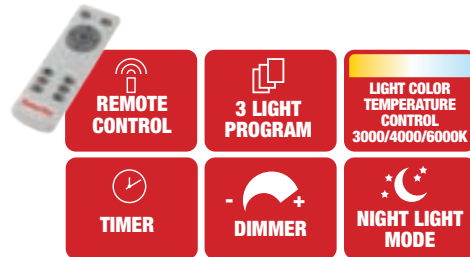

01-2335



01-2342

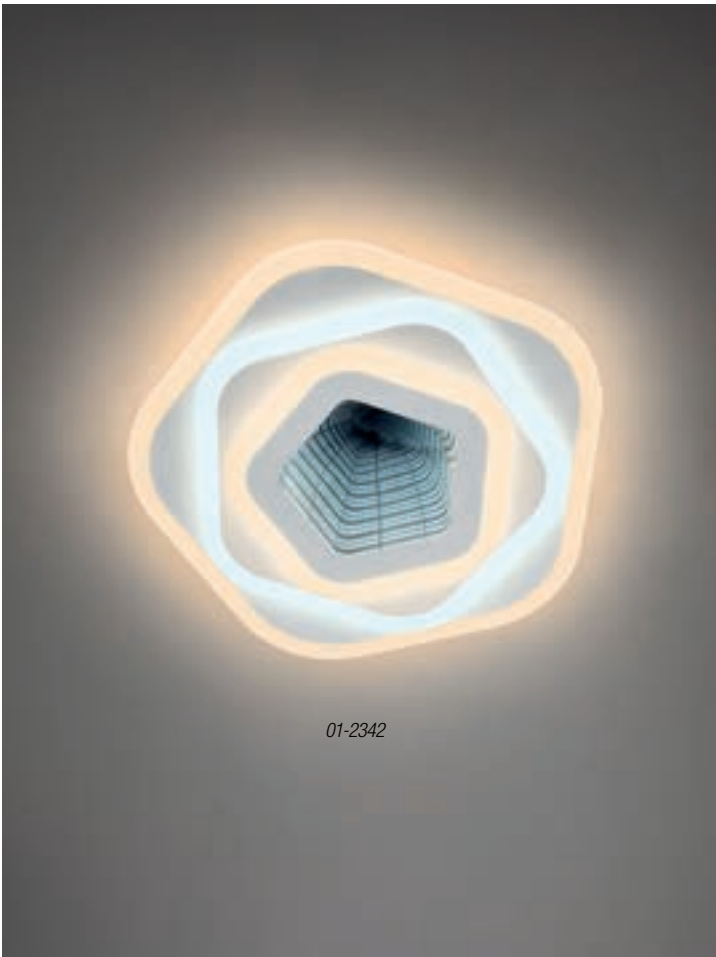

01-2342



01-2336



01-2341

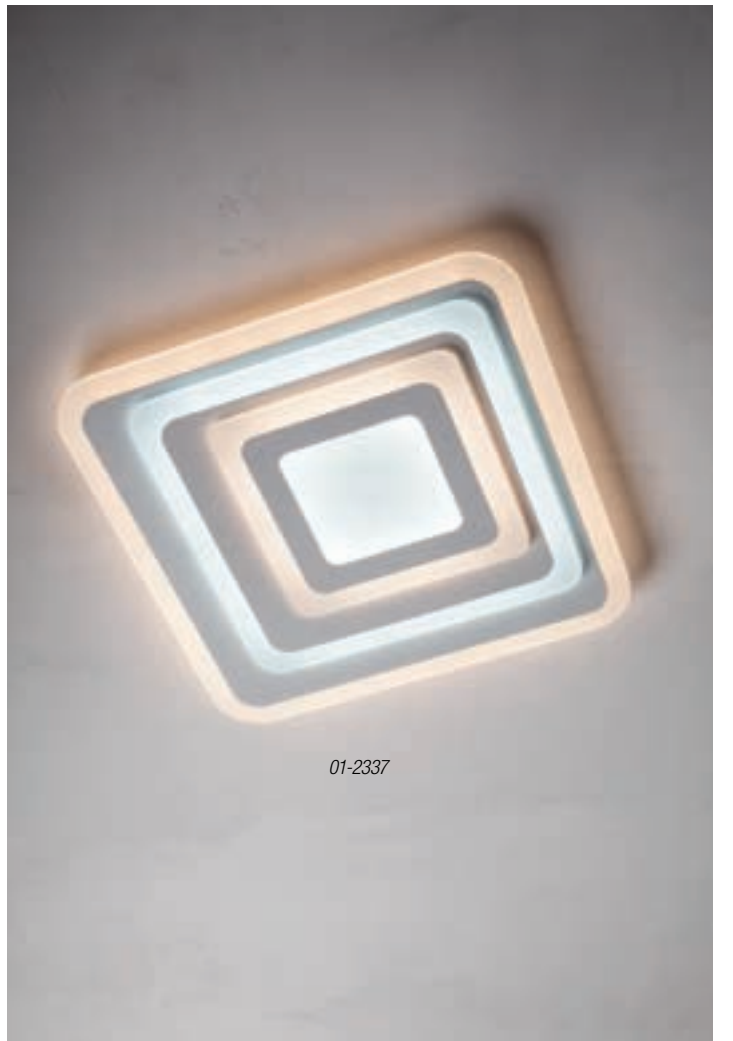

01-2337

Stratos

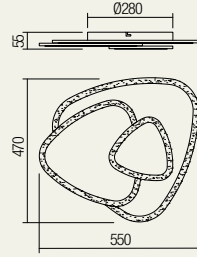

01-2451

SMD LED · 55W
 CCT 3000/4000/6000K · CRI 86
 LED flux 7500 lm
 Luminaire flux 4761 lm



01-2451

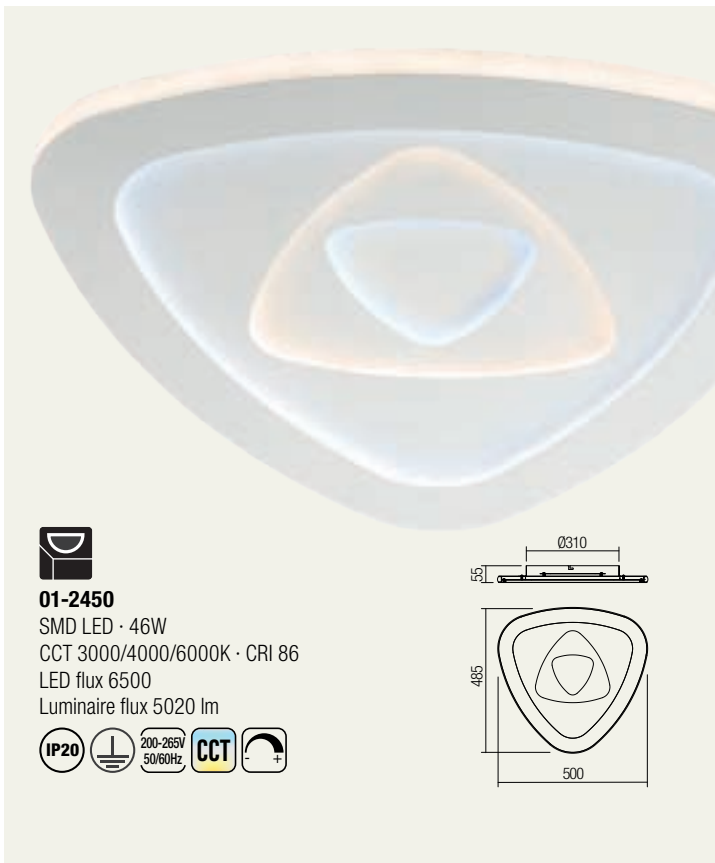

01-2450

SMD LED · 46W
 CCT 3000/4000/6000K · CRI 86
 LED flux 6500
 Luminaire flux 5020 lm

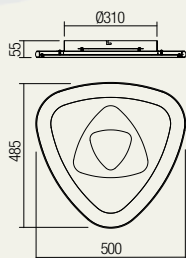

01-2450

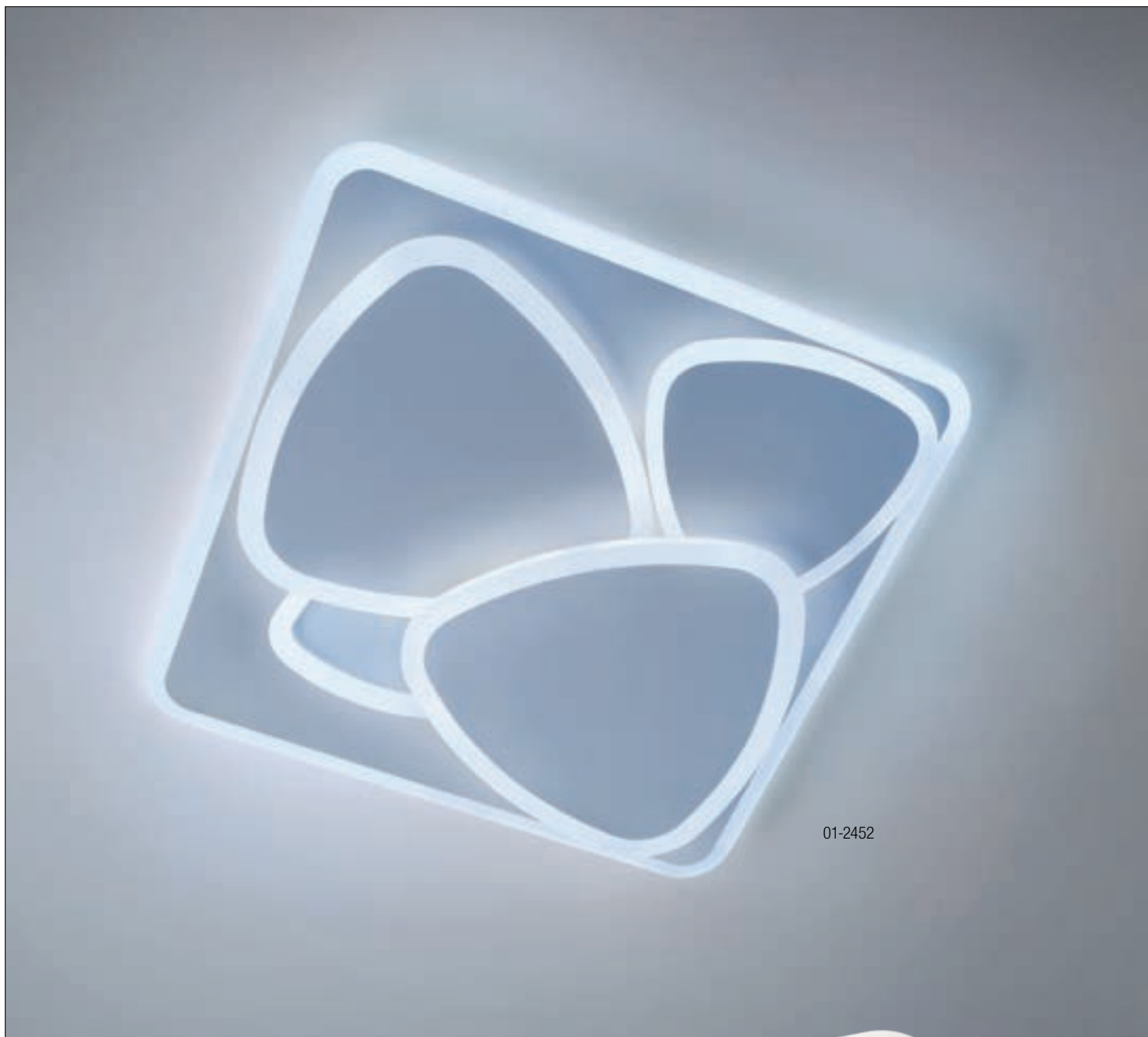

01-2452

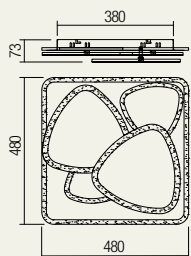
**01-2452**

SMD LED · 90W

CCT 3000/4000/6000K · CRI 86

LED flux 12500 lm

Luminaire flux 7043 lm



Stratos



- REMOTE CONTROL**
- 3 LIGHT PROGRAM**
- LIGHT COLOR TEMPERATURE CONTROL**
3000/4000/6000K
- TIMER**
- DIMMER**
- NIGHT LIGHT MODE**

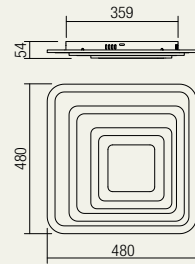
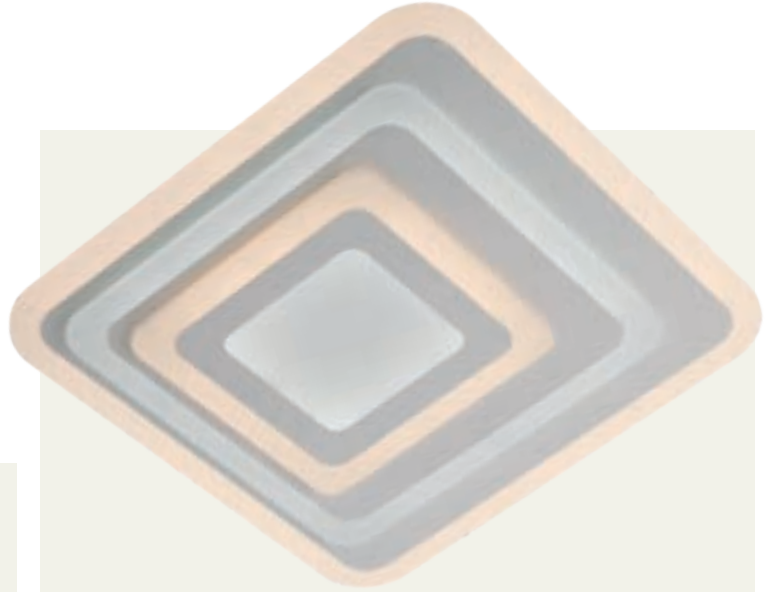

01-2337
 SMD LED · 82W
 3000/4000/6000K · CRI 85
 LED flux 10900 lm
 Luminaire flux 6625 lm

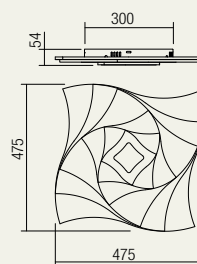
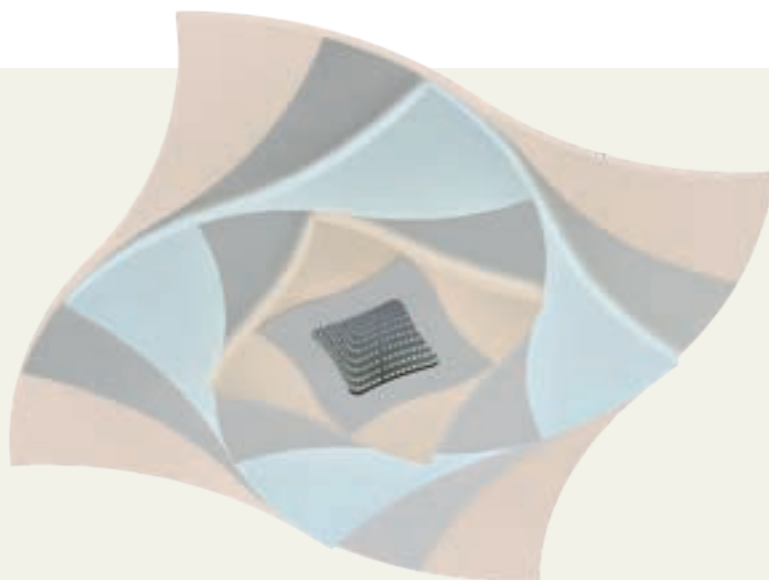

01-2335
 SMD LED · 70W
 3000/4000/6000K · CRI 85
 LED flux 8700 lm
 Luminaire flux 5199 lm

**01-2341**

SMD LED · 63W
3000/4000/6000K · CRI 85
LED flux 8580 lm
Luminaire flux 4611 lm

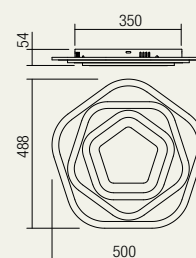
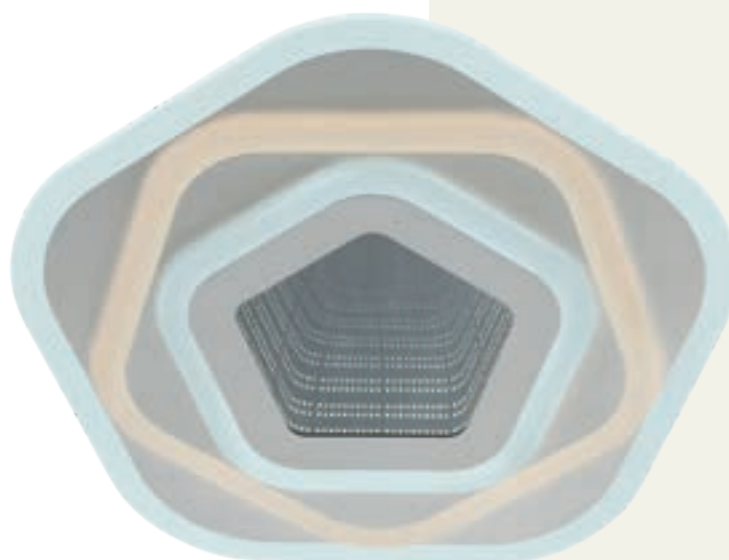
**01-2342**

SMD LED · 77W
3000/4000/6000K · CRI 85
LED flux 10000 lm
Luminaire flux 5275 lm

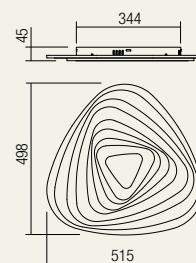
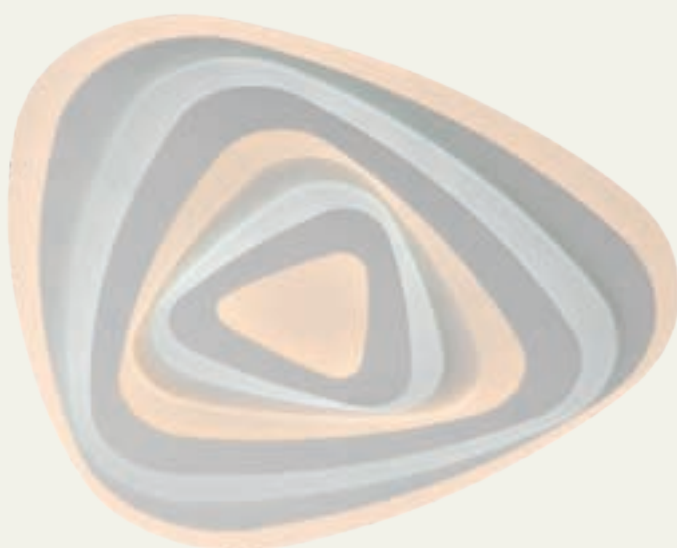
**01-2336**

SMD LED · 90W
3000/4000/6000K · CRI 85
LED flux 13200 lm
Luminaire flux 7035 lm



Nebula



Ceiling lamp for indoor equipped with SMD LEDs warm white, cool white and RGB SMD LEDs. Metal structure painted in mat white, opal methacrylate diffuser and chromed ornament. Delivered with remote control (2 AAA batteries included) with multiple functions: ON/OFF, 5 operating programs, light intensity regulation, variation of the color temperature from warm white to cool white or RGB, night light mode.

RO - Plafonieră pentru interior echipată cu LED-uri SMD alb cald, alb rece și LED-uri SMD RGB. Structură din metal vopsit alb mat, dispersor din metacrilat opal și ornament cromat. Livrată cu telecomandă (cu 2 baterii AAA incluse) cu următoarele funcții: ON/OFF, 5 programe de funcționare, reglarea intensității luminoase, setarea temperaturii de culoare a luminii de la alb cald la alb rece sau RGB, mod lumină veghe.

IT - Plafoniera per interni equipaggiata con LED SMD bianco caldo, bianco freddo e LED SMD RGB. Struttura in metallo verniciato bianco opaco, diffusore in metacrilato opale con ornamento cromato. Fornita con telecomando (2 batterie AAA incluse) con molteplici funzioni: ON/OFF, 5 programmi operativi, regolazione dell'intensità della luce, variazione della temperatura del colore da bianco caldo a bianco freddo oppure RGB e modalità luce notturna.

RU - Плафон для интерьера, оснащенный светодиодами SMD, теплый белый, холодный белый и светодиоды RGB SMD. Металлическая структура, покрашенная в матовый белый, опаловый метакрилатный рассеиватель и хромированное декоративное украшение. Поставляется с дистанционным управлением (2 батарейки AAA включены) со следующими функциями: ВКЛ / ВЫКЛ, 5 программ работы, регулирование интенсивности света, настройка цветовой температуры от теплого белого до холодного белого цвета или RGB, дежурная ночная лампочка.

HU - Beltéri mennyezeti lámpa, meleg fehér, hideg fehér SMD LED és SMD RGB LED-el szerelve, matt fehér fém szerkezet, metakril opál diszperzör, krom diszkekkel. A lámpákhoz távirányító tartozik (2db.AAA elem inkl.). A távirányítónak a következő funkciói vannak: KI/BE kapcsolás, 5 működési beállítás, fényerőszabályzás, színhőmérséklet állítás meleg fehérről hideg fehérre vagy RGB, időzítés és készenléti állapot.

BG - Таванно осветление за интериор, разполага със SMD светодиоди за топло бяло, студено бяло и SMD RGB светодиоди. Метална структура боядисана в матово бяло, дифузер от опалов метакрилатен и хромирана декорация. Доставка се с дистанционно управление (с 2 AAA батерии включени), със следните функции: ON/OFF, 5 работни програми, регулиране на интензитета на светлината, настройка за цветова температура на светлината от топло бяло до студено бяло или RGB, светлина в режим на готовност.

SK - Stropné interiérové svietidlo pre interiér vybavené SMD LED diódami teplej bielej, studenej bielej a RGB SMD LED diódami. Kovová konštrukcia lakovaná matnou bielou farbou, difúzor metakrylátového opálu a chrómovaný ornament. Dodáva sa s diaľkovým ovládaním (súčasťou balenia sú 2 batérie AAA) s viacerými funkciami: ON / OFF, 5 prevádzkových programov, regulácia intenzity svetla, zmena teploty farieb od teplej bielej po studenú bielu alebo RGB, režim nočného svetla.

RAINBOW MODE



INFINITE COLORS WITH RGB LIGHT CONTROL

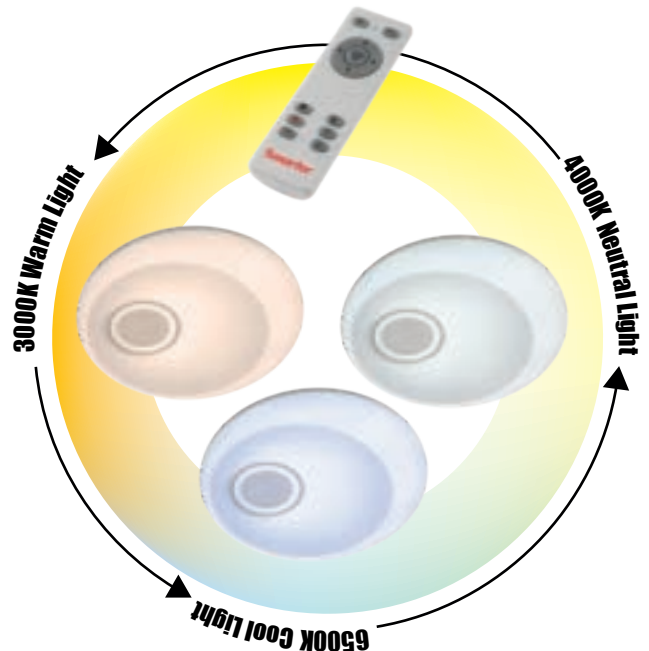

INFO/DIMENSIONS

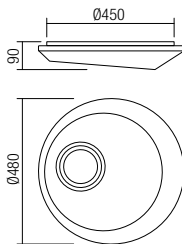



05-920

SMD LED · 48W
CCT 3000-6500K + RGB · CRI 80
LED flux 4300 lm
Luminaire flux 2650 lm





- **5 LIGHT PROGRAM**
- **LIGHT COLOR TEMPERATURE CONTROL**
3000/4000/6500K
- **RGB CONTROL**
- **REMOTE CONTROL**
- **DIMMER**
- **NIGHT LIGHT MODE**

Andes



Wi-Fi CONNECTION APP CONTROL + REMOTE CONTROL



Available on



Works with



Ceiling lamp for indoor equipped with SMD LEDs warm white, cool white and RGB SMD LEDs, with TUYA system control. Metal structure painted in mat white, opal methacrylate diffuser with glittering effect and chromed ornament. Delivered with remote control (2 AAA batteries included) with multiple functions: ON/OFF, 5 operating programs, light intensity regulation, variation of the color temperature from warm white to cool white or RGB, night light mode.

RO · Plafonieră pentru interior echipată cu led-uri SMD alb cald, alb rece și LED-uri SMD RGB, dotată cu sistem de control TUYA. Structură din metal vopsit alb mat, dispersor din metacrilat opal cu efect de sclipire și ornament cromat. Livrată cu telecomandă (cu 2 baterii AAA incluse) cu următoarele funcții: ON/OFF, 5 programe de funcționare, reglarea intensității luminoase, setarea temperaturii de culoare a luminii de la alb cald la alb rece sau RGB, mod lumină veghe.

IT · Plafoniera per interni equipaggiata con LED SMD bianco caldo, bianco freddo e LED SMD RGB, dotata di sistema di controllo TUYA. Struttura in metallo verniciato bianco opaco, diffusore in metacrilato opale brillantato con ornamento cromato. Fornita con telecomando (2 batterie AAA incluse) con molteplici funzioni: ON/OFF, 5 programmi operativi, regolazione dell'intensità della luce, variazione della temperatura del colore da bianco caldo a bianco freddo oppure RGB e modalità luce notturna.

RU · Потолочный светильник для внутреннего освещения, оснащенный светодиодами SMD теплого белого, холодного белого свечения и RGB SMD, с системой управления TUYA. Металлическая структура, окрашенная в матовый белый цвет, рассеиватель из опалового метакрилата с блестящим эффектом и хромированным орнаментом. Поставляется с пультом дистанционного управления (2 батарейки AAA в комплекте) с несколькими функциями: ВКЛ/ВЫКЛ, 5 рабочих программ, регулировка яркости света, изменение цветовой температуры от теплого белого до холодного белого или RGB, режим ночного освещения.

HU · Meleg-fehér és hideg-fehér SMD LED-ekkel és RGB SMD LED-ekkel felszerelt beltéri mennyezetlámpa, TUYA vezérlőrendszerrel. Matt fehérre festett fémstruktúra, csillgó hatású opál metakrilát fényoszóró és krómozott díszelemekkel. Távirányítóval jön (amely 2 AAA elemet tartalmaz), amelynek a funkciói a következők: BE/KI, 5 működési program, a fényerő szabályozása, a színhőmérséklet szabályozása meleg fehértől hideg fehérig, vagy RGB, virrasztófény üzemmód.

BG · Таванно осветление за интериор, оборудвано със SMD светодиоди, с топло бяла, топло студена светлина и SMD RGB светодиоди, със система за управление TUYA. Метална структура боядисана в матово бяло, дифузер от опалов метакрилат с блестящ ефект и хромирана декорация. Доставка се дистанционно управление (с 2 AAA батерии включени), със следните функции: ON/OFF (ВКЛЮЧВАНЕ/ИЗКЛЮЧВАНЕ), 5 операционни програми, регулиране на силата на светлината, избиране на цветоата температура на светлината от топло бяло до студено бяло или RGB, режим на готовност.

SK · Interiérové stropné svietidlo vybavené teplou bielou, studenou bielou SMD LED a RGB SMD LED, vybavené riadiacim systémom TUYA. Štruktúra z matného bieleho lakovaného kovu, difúzor z lešteného opálového metakrylátu s chrómovaným ornamentom. Dodáva sa s diaľkovým ovládaním (vrátane 2 batérií typu AAA) s viacerými funkciami: ZAP/VYP, 5 prevádzkových programov, nastavenie intenzity svetla, kolísanie teploty od teplej bielej po studenú bielu alebo RGB a nočné osvetlenie.

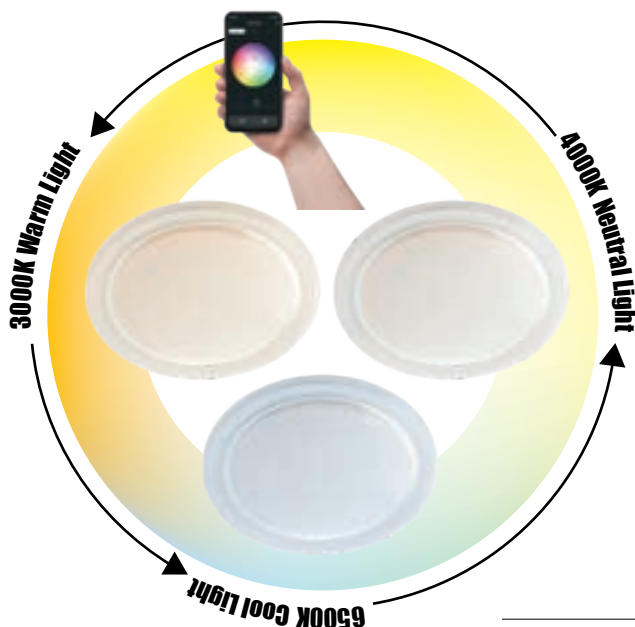

**INFINITE COLORS
WITH RGB
LIGHT CONTROL**



**DIFFUSER WHIT
GLITTERING EFFECT**

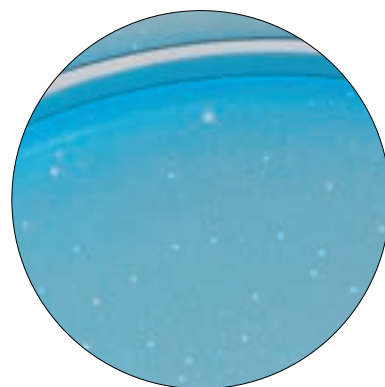

INFO/DIMENSIONS

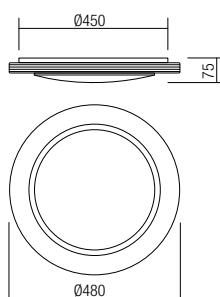

05-917

SMD LED 48W
CCT 3000-6500K + RGB
CRI 80
LED flux 5200 lm
Luminaire flux 3024 lm



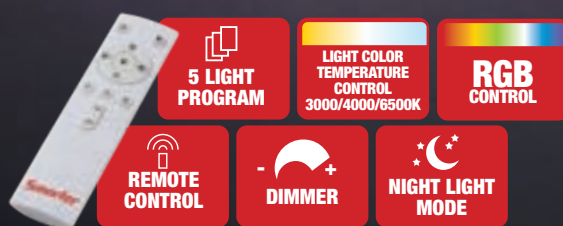

Azul



Wi-Fi CONNECTION APP CONTROL + REMOTE CONTROL



Available on



Works with



Ceiling lamp for indoor equipped with SMD LEDs warm white, cool white and RGB SMD LEDs, with TUYA system control. Metal structure painted in mat white, opal methacrylate diffuser with glittering effect, central decoration and chromed ornament. Delivered with remote control (2 AAA batteries included) with multiple functions: ON/OFF, 5 operating programs, light intensity regulation, variation of the color temperature from warm white to cool white or RGB, night light mode.

RO · Plafonieră pentru interior echipată cu led-uri SMD alb cald, alb rece și LED-uri SMD RGB, dotată cu sistem de control TUYA. Structură din metal vopsit alb mat, dispersor din metacrilat opal cu efect de sclipire, decorațiune centrală și ornament cromat. Livrată cu telecomandă (cu 2 baterii AAA incluse) cu următoarele funcții: ON/OFF, 5 programe de funcționare, reglarea intensității luminoase, setarea temperaturii de culoare a luminii de la alb cald la alb rece sau RGB, mod lumină veghe.

IT · Plafoniera per interni equipaggiata con LED SMD bianco caldo, bianco freddo e LED SMD RGB, dotata di sistema di controllo TUYA. Struttura in metallo verniciato bianco opaco, diffusore in metacrilato opale brillantato con decorazione centrale e ornamento cromato. Fornita con telecomando (2 batterie AAA incluse) con molteplici funzioni: ON/OFF, 5 programmi operativi, regolazione dell'intensità della luce, variazione della temperatura del colore da bianco caldo a bianco freddo oppure RGB e modalità luce notturna.

RU · Потолочный светильник для внутреннего освещения, оснащенный светодиодами SMD теплого белого, холодного белого свечения и RGB SMD, с системой управления TUYA. Металлическая структура, окрашенная в матовый белый цвет, рассеиватель из опалового метакрилата с блестящим эффектом и хромированным орнаментом. Поставляется с пультом дистанционного управления (2 батарейки AAA в комплекте) с несколькими функциями: ВКЛ/ВЫКЛ, 5 рабочих программ, регулировка яркости света, изменение цветовой температуры от теплого белого до холодного белого или RGB, режим ночного освещения.

HU · Meleg-fehér, hideg-fehér SMD LED-ekkel és RGB SMD LED-ekkel felszerelt beltéri mennyezeti lámpa, TUYA vezérlőrendszerrel. Matt fehérre festett fémstruktúra, csillogó hatású opál metakrilát fényező és krómozott díszelemekkel. Távirányítóval jön (amely 2 AAA elemet tartalmaz), amelynek a funkciói a következők: BE/KI, 5 működési program, a fényerő szabályozása, a színhőmérséklet szabályozása meleg fehértől hideg fehérig vagy RGB-ig, virrasztófény üzemmód.

BG · Таванно осветление за интериор, оборудвано със SMD светодиоди, с топло бяла, топло студена светлина и SMD RGB светодиоди, със система за управление TUYA. Метална структура боядисана в матово бяло, дифузер от опалов метакрилат с блестящ ефект, централна декорация и хромирана украса. Доставка се дистанционно управление (с 2 AAA батерии включени), със следните функции: ON/OFF (ВКЛЮЧВАНЕ/ИЗКЛЮЧВАНЕ), 5 операционни програми, регулиране на силата на светлината, избиране на цветовата температура на светлината от топло бяло до студено бяло или RGB, режим на готовност.

SK · Interiérové stropné svetidlo vybavené teplou bielou, studenou bielou SMD LED a RGB SMD LED, vybavené riadiacim systémom TUYA. Matná biela lakovaná kovová štruktúra, difúzor z lešteného opálového metakrylátu s centrálnou dekoráciou a chrómovaným ornamentom. Dodáva sa s diaľkovým ovládaním (vrátane 2 batérií typu AAA) s viacerými funkciami: ZAP/VYP, 5 prevádzkových programov, nastavenie intenzity svetla, kolísanie teploty od teplej bielej po studenú bielu alebo RGB a nočné osvetlenie.

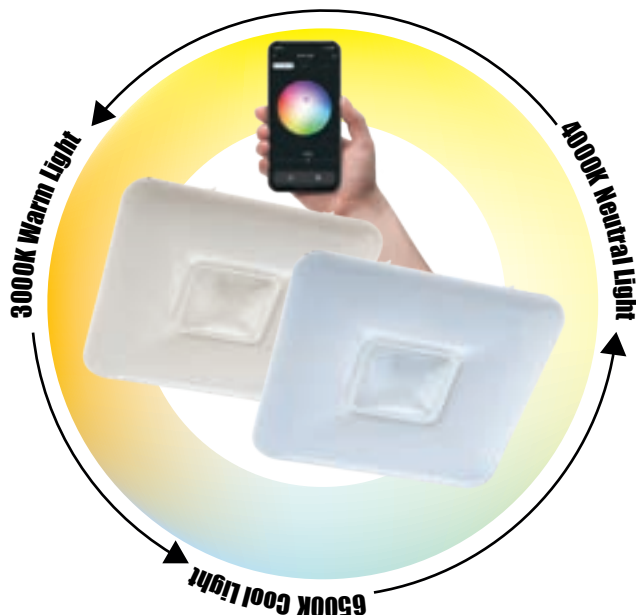

**INFINITE COLORS
WITH RGB
LIGHT CONTROL**

**DIFFUSER WHIT
GLITTERING EFFECT**



INFO/DIMENSIONS

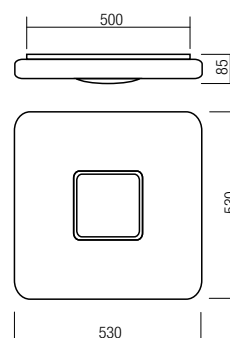

05-918

SMD LED 48W
CCT 3000-6500K + RGB
CRI 80
LED flux 5200 lm
Luminaire flux 3024 lm



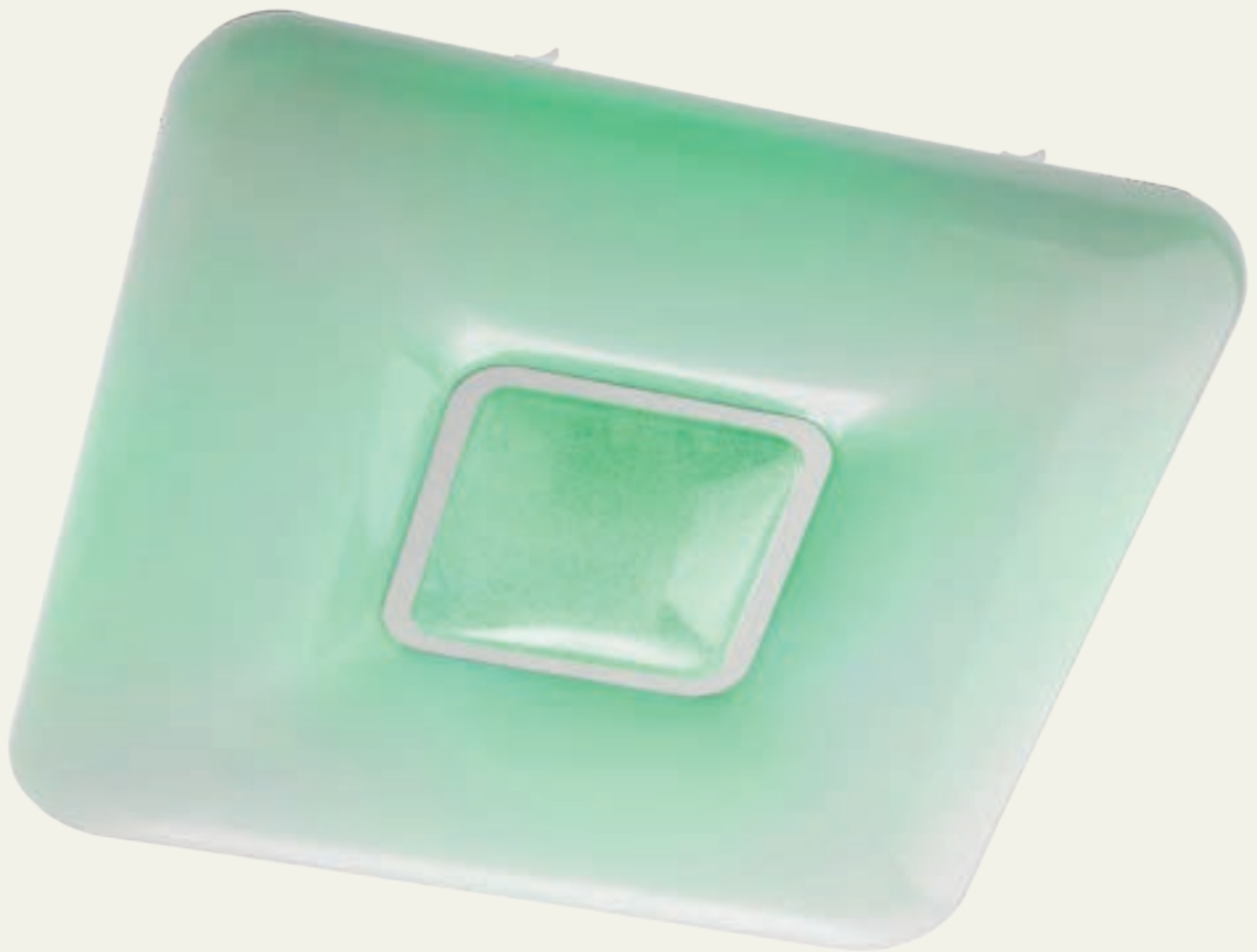

Azuki



Ceiling lamp for indoor equipped with SMD LEDs, metal structure painted in mat white, opal and transparent acrylic diffusers with air bubbles effect. Delivered with remote control (2 AAA batteries included) with multiple functions: ON/OFF, 3 operating programs, light intensity regulation, variation of the color temperature from warm white to cool white, timer and night light mode.

RO · Plafonieră pentru interior echipată cu LED-uri SMD, structură din metal vopsit alb mat cu dispersoare din acril opal și acril transparent cu efect de bule de aer. Livrată cu telecomandă (cu 2 baterii AAA incluse) cu următoarele funcții: ON/OFF, 3 programe de funcționare, reglarea intensității luminoase, setarea temperaturii de culoare a luminii de la alb cald la alb rece, timer și mod lumină veghe.

IT · Plafoniera per interni equipaggiata con LED SMD, struttura in metallo verniciato bianco opaco, diffusori in acrilico opal e acrilico trasparente con effetto bolle. Fornita con telecomando (2 batterie AAA incluse) con molteplici funzioni: ON/OFF, 3 programmi operativi, regolazione dell'intensità della luce, variazione della temperatura del colore da bianco caldo a bianco freddo, timer e modalità luce notturna.

RU · Плафон для интерьера, оснащенный светодиодами SMD, металлическая структура, покрашенная в матовый белый, акриловые рассеиватели опаловый и прозрачный с эффектом воздушных пузырьков. Поставляется с дистанционным управлением (2 батарейки AAA включены) со следующими функциями: ВКЛ / ВЫКЛ, 3 программы работы, регулирование интенсивности света, настройка цветовой температуры от теплого белого до холодного белого цвета, таймер и дежурная ночная лампочка.

HU · Beltéri mennyezeti lámpa, SMD LED-el szerelve, matt fehér fém szerkezet, levegő buborék hatású áttetsző akril diszperzör. Állítható szín hőmérséklet meleg fehérről hideg fehérre. A mennyezeti lámpákhoz távirányító tartozik (2db. AAA elem inkl.). A távirányítóknak a következő funkciói vannak: KI/BE kapcsolás, 3 működési beállítás, fényerőszabályzás, színhőmérséklet állítás meleg fehérről hideg fehérre, időzítés és készenléti állapot.

BG · Таванно осветление за интериор, разполага със SMD светодиоди, метална структура, боядисана в матово бяло, с дифузери от опалов акрилен и прозрачен акрилен, с ефект на мехурчета. Доставка се с дистанционно управление (с 2 AAA батерии включени), със следните функции: ON/OFF, 3 работни програми, регулиране на интензитета на светлината, настройка за цветовата температура на светлината от топло бяло до студено бяло, таймер и светлина в режим на готовност.

SK · Stropné interiérové svetidlo vybavené SMD LED diódami, kovová konštrukcia lakovaná matnou bielou, opál a priehľadné akrylové difúzory s efektom vzduchových bublín. Dodáva sa s diaľkovým ovládaním (súčasťou balenia sú 2 batérie AAA) s viacerými funkciami: ON / OFF, 3 prevádzkové programy, regulácia intenzity svetla, zmena teploty farieb od teplej bielej po studenú bielu, režim časovača a nočného svetla.

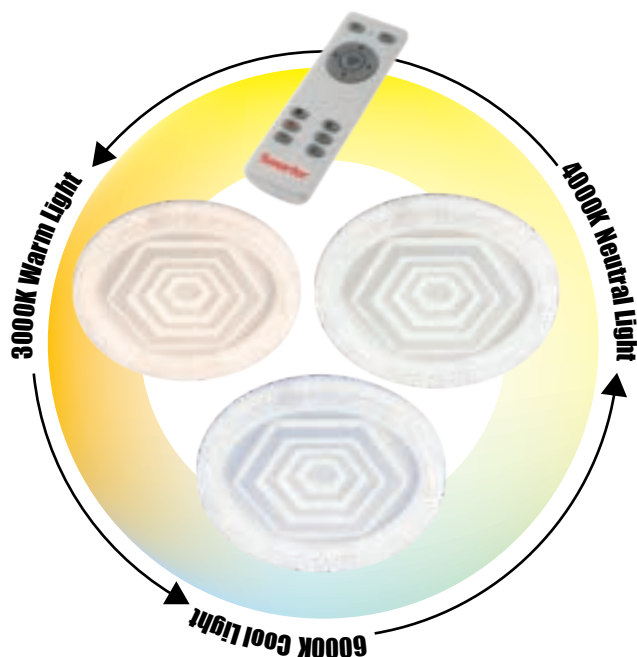

INFO/DIMENSIONS

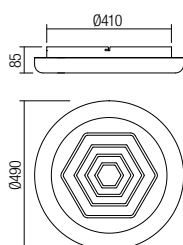

05-921

SMD LED · 110W
CCT 3000/4000/6000K · CRI 86
LED flux 14000 lm
Luminaire flux 8140 lm

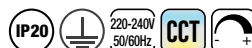



05-921

Squash



Ceiling lamp for indoor equipped with SMD LEDs, with TUYA system control. Metal structure painted in mat white, opal methacrylate diffuser with glittering effect and chromed ornament. Delivered with remote control (2 AAA batteries included) with multiple functions: ON/OFF, 5 operating programs, light intensity regulation, variation of the color temperature from warm white to cool white or RGB, night light mode.

RO - Plafonieră pentru interior echipată cu LED-uri SMD, dotată cu sistem de control TUYA. Structură din metal vopsit alb mat, dispersor din metacrilat opal cu efect de sclipire și ornament cromat. Livrată cu telecomandă (cu 2 baterii AAA incluse) cu următoarele funcții: ON/OFF, 5 programe de funcționare, reglarea intensității luminoase, setarea temperaturii de culoare a luminii de la alb cald la alb rece sau RGB, mod lumină veghe.

IT - Plafoniera per interni equipaggiata con LED SMD, dotata di sistema di controllo TUYA. Struttura in metallo verniciato bianco opaco, diffusore in metacrilato opale brillantato con ornamento cromato. Fornita con telecomando (2 batterie AAA incluse) con molteplici funzioni: ON/OFF, 5 programmi operativi, regolazione dell'intensità della luce, variazione della temperatura colore, da bianco caldo a bianco freddo, oppure RGB e modalità luce notturna.

RU - Плафон для интерьера, оснащенный светодиодами SMD, с системой управления TUYA. Металлическая структура, покрашенная в матовый белый, опаловый метакрилатный рассеиватель с эффектом блеска и хромированным декоративным украшением. Поставляется с дистанционным управлением (2 батарейки AAA включены) со следующими функциями: ВКЛ / ВЫКЛ, 5 программ работы, регулирование интенсивности света, настройка цветовой температуры от теплого белого до холодного белого цвета или RGB, дежурная ночная лампочка.

HU - Beltéri mennyezeti lámpák, SMD LED-el szerelve, TUYA rendszerrel. Matt fehér fém szerkezet, csillogó opal metakril diszperzór, króm dísz. Távirányítóval szállítva (inkl. 2 AAA elem), a következő funkciókkal: ON/OFF kapcsolat, 5 működési program, fényerőszabályzás, állítható színhőmérséklet meleg fehérről hideg fehérre és RGB-re, ór fény.

BG - Таванно осветление за интериор, оборудвано със SMD светодиоди, разполага с контролна система TUYA. Метална структура, боядисана в матово бяло, опалов метакрилатен дифузер с блестящ ефект и хромирано украшение. Предлага се с дистанционно управление (с 2 включени AAA батерии), със следните функции: ON/OFF, 5 работни програми, регулиране на интензитета на светлината, настройване на цветната температура на светлината от топло бяло до студено бяло или RGB, светлина в режим на готовност.

SK - Vnútné stropné svetidlo vybavené SMD LED diódami, s ovládaním systému TUYA. Kovová konštrukcia lakovaná matnou bielou, opalový metakrylátový difúzor s trblietavým efektom a pochrómovaným ornamentom. Dodáva sa s diaľkovým ovládaním (2 batérie AAA sú súčasťou dodávky) s viacerými funkciami: ZAP/VYP, 5 operačných programov, regulácia intenzity svetla, zmena teploty farby od teplej bielej po studenú bielu alebo RGB, režim nočného svetla.

Wi-Fi CONNECTION APP CONTROL + REMOTE CONTROL



Available on



Works with

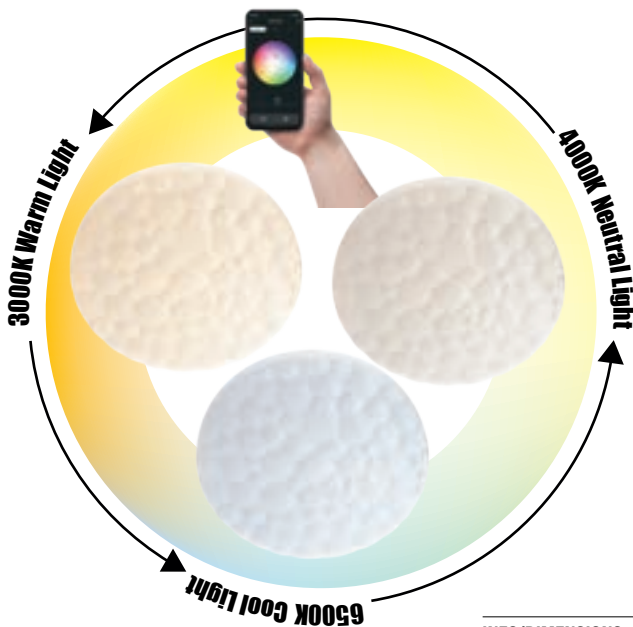

INFINITE COLORS WITH RGB LIGHT CONTROL

INFO/DIMENSIONS

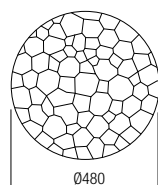
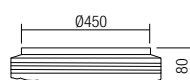

05-926

SMD LED · 48W
CCT 3000-6500K + RGB · CRI 80
LED flux 5200 lm
Luminaire flux 3221 lm





Galax



Ceiling lamp for indoor equipped with SMD LEDs warm white and cool white, with TUYA system control. Metal structure painted in mat white, opal methacrylate diffuser with glittering effect and central decoration, chromed ornaments. Delivered with remote control (2 AAA batteries included) with multiple functions: ON/OFF, 4 operating programs, light intensity regulation, variation of the color temperature from warm white to cool white, night light mode.

Wi-Fi CONNECTION APP CONTROL + REMOTE CONTROL



Available on



Works with



RO - Plafonieră pentru interior echipată cu led-uri SMD alb cald și alb rece, dotată cu sistem de control TUYA. Structură din metal vopsit alb mat, dispersor din metacrilat opal cu decorațiune centrală și ornamente cromate. Livrată cu telecomandă (cu 2 baterii AAA incluse) cu următoarele funcții: ON/OFF, 4 programe de funcționare, reglarea intensității luminoase, setarea temperaturii de culoare a luminii de la alb cald la alb rece, mod lumină veghe.

IT - Plafoniera per interni equipaggiata con LED SMD bianco caldo, bianco freddo, dotata di sistema di controllo TUYA. Struttura in metallo verniciato bianco opaco, diffusore in metacrilato opale brillantato con decorazione centrale e ornamenti cromati. Fornita con telecomando (2 batterie AAA incluse) con molteplici funzioni: ON/OFF, 4 programmi operativi, regolazione dell'intensità della luce, variazione della temperatura del colore da bianco caldo a bianco freddo e modalità luce notturna.

RU - Потолочный светильник для внутреннего освещения, оснащенный светодиодами SMD теплого белого и холодного белого цвета, с системой управления TUYA. Металлическая структура, окрашенная в матовый белый цвет, опаловый метакрилатный диффузор с блестящим эффектом и центральной отделкой, хромированные орнаменты. Поставляется с пультом дистанционного управления (2 батарейки AAA в комплекте) с несколькими функциями: ВКЛ/ВЫКЛ, 4 рабочие программы, регулировка интенсивности света, изменение цветовой температуры от теплого белого до холодного белого, режим ночного освещения.

HU - Meleg-fehér és hideg-fehér SMD LED-ekkel és RGB SMD LED-ekkel felszerelt beltéri mennyezeti lámpa, TUYA vezérlőrendszerrel. Matt fehérre festett fémstruktúra, csillgó hatású opál metakrilát fényzóró és krómzott díszelemekkel. Távirányítóval jön (amely 2 AAA elemet tartalmaz), amelynek a funkciói a következők: BE/KI, 4 működési program, a fényerő szabályozása, a színhőmérséklet szabályozása meleg fehértől hideg fehérig, virrasztófény üzemmód.

BG - Таванно осветление за интериор, оборудвано със SMD светодиоди, с топло бяла и студена бяла светлина, и система за управление TUYA. Метална структура боядисана в матово бяло, дифузер от опалов метакрилат, с централна декорация и хромирани украси. Доставка се дистанционно управление (с 2 AAA батерии включени), със следните функции: ON/OFF (ВКЛЮЧВАНЕ/ИЗКЛЮЧВАНЕ), 4 операционни програми, регулиране на силата на светлината, избиране на цветовата температура на светлината от топло бяло до студено бяло, режим на готовност.

SK - Interiérové stropné svietidlo vybavené teplou bielou, studenou bielou LED diódou SMD, vybavené riadiacim systémom TUYA. Matná biela lakovaná kovová štruktúra, difúzor z lešteného opálového metakrylátu s centrálnou dekoráciou a chrómovanými ornamentami. Dodáva sa s diaľkovým ovládaním (vrátane 2 AAA batérií) s viacerými funkciami: ZAP/VYP, 4 operačné programy, nastavenie intenzity svetla, kolísanie teploty od teplého bieleho po studené biele a nočné svetlo.

DIFFUSER WHIT GLITTERING EFFECT

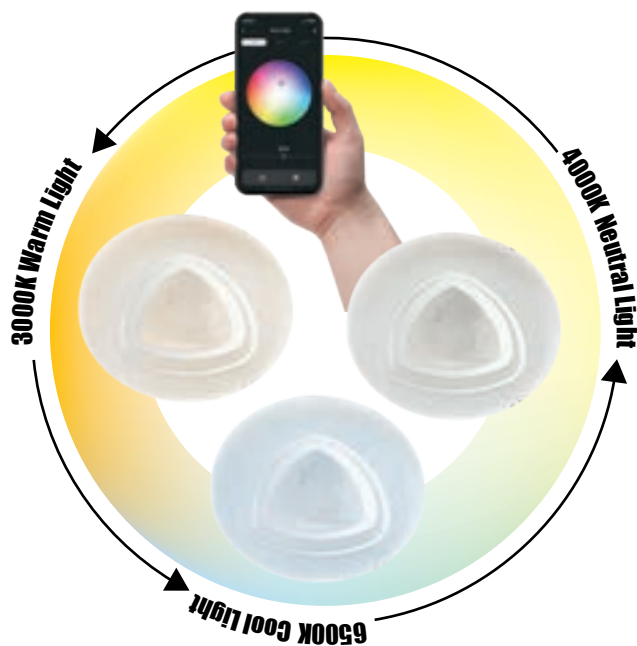

INFO/DIMENSIONS

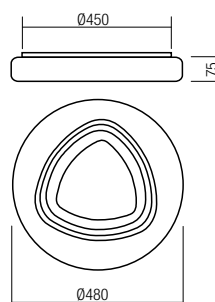

05-919

SMD LED 48W
CCT 3000-6500K
CRI 80
LED flux 5200 lm
Luminaire flux 3324 lm





Sumo



Ceiling lamp for indoor equipped with SMD LEDs. Metal structure painted in mat white, opal PMMA diffuser with central decoration and chromed ornament, coffee plastic outer frame.

RO · Plafonieră pentru interior echipată cu LED-uri SMD. Structură din metal vopsit alb mat, dispersor din PMMA opal cu decorațiune centrală și ornament cromat, cornișă exterioară din plastic cafeniu.

IT · Plafoniera per interni equipaggiata con LED SMD. Struttura in metallo verniciato bianco opaco, diffusore in PMMA opale con decorazione centrale e ornamento cromato, cornice esterna in plastica caffè.

RU · Плафон для интерьера, оснащенный светодиодами SMD, металлическая структура, покрашенная в матовый белый, опаловый рассеиватель из PMMA, с центральным украшением и хромированным декоративным украшением, с пластиковой рамой кофейного цвета с наружной стороны.

HU · Beltéri mennyezeti lámpák, SMD LED-el szerelve. Matt fehér fém szerkezet, opál PMMA diszperzór központi dísszel, műanyag kávé színű külső rész.

BG · Таванно осветление за интериор, оборудвано със SMD светодиоди. Метална структура, боядисана в матово бяло, PMMA опалов дифузер с централна декорация и хромирано украшение, външен корниз от кафява пластмаса.

SK · Stropné svetidlo do interiéru vybavené LED diódami SMD. Kovová konštrukcia lakovaná v matnej bielej farbe, opálový difúzor PMMA s centrálnou ozdobou a pochrómovaným ornamentom, vonkajší plastový rám v kávevej farbe.



05-925

INFO/DIMENSIONS



05-925 White

SMD LED · 36W · 4000K · CRI 80

LED flux 3750 lm

Luminaire flux 1656 lm

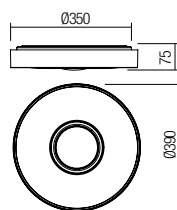



Optic



Ceiling lamp for indoor equipped with SMD LEDs. Metal structure painted in mat white, opal PMMA diffuser with transparent outer frame and chromed ornament.

RO · Plafonieră pentru interior echipată cu LED-uri SMD. Structură din metal vopsit alb mat, dispersor din PMMA opal cu cornișă exterioară transparentă și ornament cromat.

IT · Plafoniera per interni equipaggiata con LED SMD. Struttura in metallo verniciato bianco opaco, diffusore in PMMA opale con cornice trasparente e ornamento cromato.

RU · Плафон для интерьера, оснащенный светодиодами SMD, металлическая структура, покрашенная в матовый белый, опаловый рассеиватель из PMMA, с прозрачной рамой с наружной стороны и хромированным декоративным украшением.

HU · Beltéri mennyezeti lámpák, SMD LED-el szerelve. Matt fehér fém szerkezet, opál PMMA diszperzór, kívül áttetsző résszel, króm dísz.

BG · Таванно осветление за интериор, оборудвано със SMD светодиоди. Метална структура, боядисана в матово бяло, PMMA опалов дифузер с прозрачен външен корниз и хромирано украшение.

SK · Interiérové stropné svietidlo vybavené LED diódami SMD Kovová konštrukcia lakovaná v matnej bielej farbe, opalový difúzor PMMA s priehľadným vonkajším rámom a pochrómovaným ornamentom.



05-924



INFO/DIMENSIONS



05-924 White

SMD LED · 46W · 4000K · CRI 80

LED flux 4900 lm

Luminaire flux 2892 lm

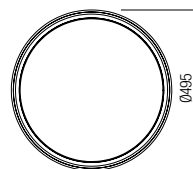
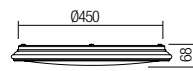



Memo

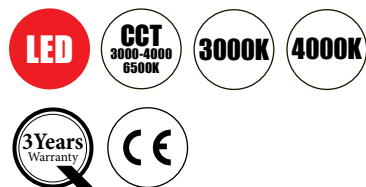

Ceiling lamps for indoor equipped with SMD LEDs, direct/indirect light emission. Structure of polycarbonate and ABS with mat white or mat black finish with diffuser of opal polycarbonate and variants with structure of PP and ABS with mat white or mat black finish with diffuser of opal PS. Available in versions which allow variation of the light color temperature from warm white to cool white by wall switch.

RO · Plafoniere pentru interior echipate cu LED-uri SMD, emisie directă/indirectă a luminii. Structură din policarbonat și ABS alb mat sau negru mat cu dispersor din policarbonat opal și variante cu structura din PP și ABS alb mat sau negru mat cu dispersor din PS opal. Disponibile în versiuni care permit setarea temperaturii de culoare a luminii de la alb cald la alb rece prin acționarea comutatorului.

IT · Plafoniere per interni equipaggiate con LED SMD, ad emissione luminosa diretta/indiretta. Struttura in policarbonato e ABS bianco opaco o nero opaco con diffusore in policarbonato opale e varianti con struttura in PP e ABS bianco opaco o nero opaco con diffusore in PS opale. Disponibile in versioni che consentono la variazione della temperatura del colore, da bianco caldo a bianco freddo tramite il commutatore a parete.

RU · Потолочные светильники для интерьера, оснащенные светодиодами SMD, с прямым/отраженным излучением света. Каркас из поликарбоната и ABS, матовый белый или черный матовый с рассеивателем из опалового поликарбоната и варианты с каркасом из PP и матовым белым или матовым черным ABS с рассеивателем из опалового PS. Доступны версии, позволяющие изменять цветовую температуру света от теплого белого до холодного белого при помощи выключателя.

HU · Beltéri mennyezeti lámpák, SMD LED-el szerelve, direkt/indirekt fény szórású. Matt fehér vagy matt fekete polikarbonát és ABS szerkezet, PS opál diszperzör. Egyes változatoknál állítható színhőmérséklet, meleg fehérről hideg fehérre.

BG · Таванни лампи за закрито оборудвани с SMD светодиоди, директно/непряко излъчване на светлина. Структура от поликарбонат и ABS с матово бяло или матово черно покритие с дифузьор от опал поликарбонат и варианти със структура от PP и ABS с матово бяло или матово черно покритие с дифузьор от опал PS. Предлага се във версии, които позволяват промяна на цветовата температура на светлината от топло бяло до студено бяло чрез превключвател на стената.

SK · Interiérové stropné svietidlá vybavené SMD LED, s priamym/nepriamym svietením. Konštrukcia z polykarbonátu a ABS v matnej bielej alebo v matnej čiernej povrchovej úprave, difúzor z opálového polykarbonátu a varianty štruktúry z PP a ABS v matnej bielej alebo v matnej čiernej farby s opálovým PS difúzorom. Dostupné vo verziách, ktoré umožňujú zmenu teploty farby svetla od teplej bielej po studenú bielu nástenným vypínačom.

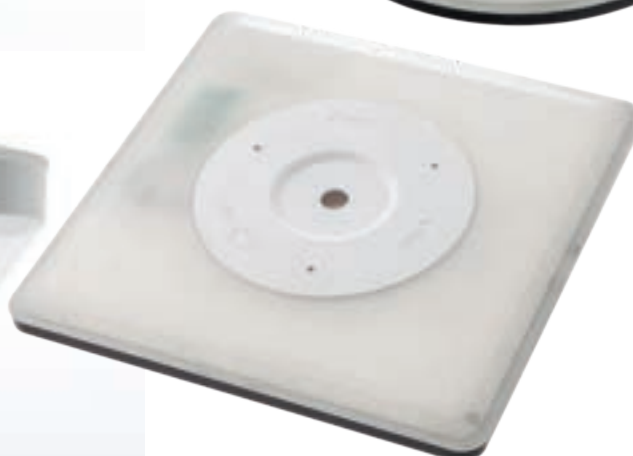
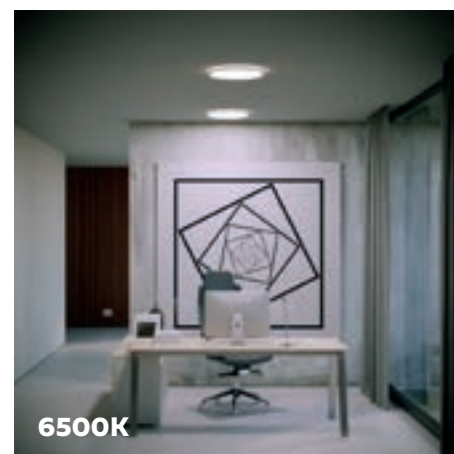
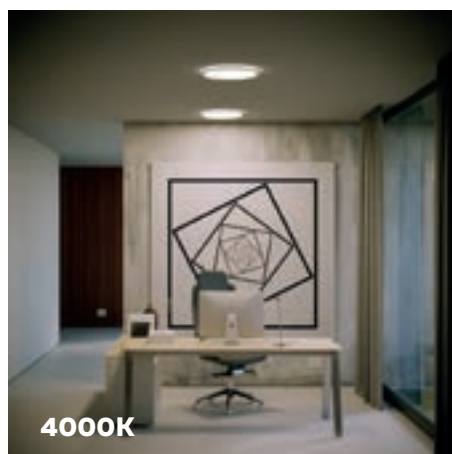
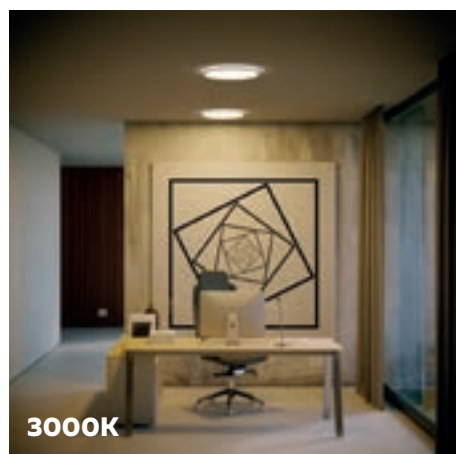

INFO/DIMENSIONS



CCT VERSIONS

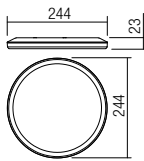

05-942 White
05-943 Black

SMD LED 15W
CCT 3000/4000/6500K · CRI 80
LED flux 3000K: 1800 lm, 4000K: 1900 lm, 6500K: 1900 lm
Luminaire flux 3000K: 1300 lm, 4000K: 1450 lm, 6500K: 1450 lm



SINGLE COLOR TEMPERATURE VERSIONS

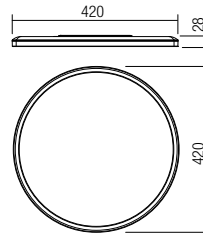

05-944 White
05-945 Black

SMD LED · 24W · 3000K · CRI 80
LED flux 2900 lm
Luminaire flux 2200 lm

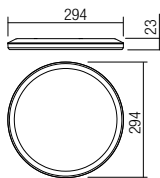

05-934 White
05-935 Black

SMD LED · 24W
CCT 3000/4000/6500K · CRI 80
LED flux 3000K: 2600 lm, 4000K: 2700 lm, 6500K: 2700 lm
Luminaire flux 3000K: 1700 lm, 4000K: 1900 lm, 6500K: 1900 lm

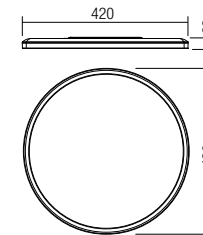

05-938 White
05-939 Black

SMD LED · 24W · 4000K · CRI 80
LED flux 3000lm
Luminaire flux 2200 lm

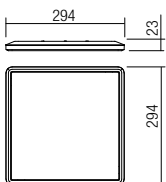

05-936 White
05-937 Black

SMD LED · 24W
CCT 3000/4000/6500K · CRI 80
LED flux 3000K: 2600 lm, 4000K: 2700 lm, 6500K: 2700 lm
Luminaire flux 3000K: 1800 lm, 4000K: 2000 lm, 6500K: 2000 lm

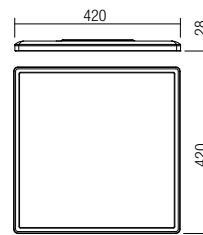

05-940 White
05-941 Black

SMD LED · 24W · 3000K · CRI 80
LED flux 2900 lm
Luminaire flux 2200 lm

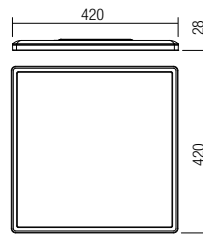

05-946 White
05-947 Black

SMD LED · 24W · 4000K · CRI 80
LED flux 3000 lm
Luminaire flux 2200 lm



Verena



Ceiling lamps for interior equipped with SMD LEDs, metal structure painted in white with black polycarbonate triangular frame, white acryl diffuser with glittering effect.

RO · Plafoniere pentru interior echipate cu LED-uri SMD, structură din metal vopsit alb cu ramă triunghiulară din policarbonat negru, dispersor din acril alb cu efect de sclipire.

IT · Plafoniere per interni equipaggiate con LED SMD, struttura in metallo verniciato bianco con cornice triangolare in policarbonato nero, diffusore in acrilico bianco finitura brillantata.

RU · Плафоны для интерьера, оснащенные светодиодами SMD, металлическая структура, покрашенная в белый цвет, с треугольным поликарбонатным черным обрамлением, белый акриловый рассеиватель с эффектом блеска.

HU · Beltéri mennyezeti lámpák, SMD LED-el szerelve, fehér fémszerkezet háromszögű fekete polikarbonát kerettel, csillogó fehér akril diszperzór.

BG · Тавани осветления за интериор, разполагат с SMD светодиоди, метална структура, боядисана в бяло, с триъгълна рамка от черен поликарбонат, дифузер от бял акрилен с ефект на блясък.

SK · Stropné interiérové svietidlá vybavené SMD LED diódami, kovová konštrukcia lakovaná na bielo s čiernym polykarbonátovým trojuholníkovým rámom, biely akrylový difúzor s trblietavým efektom.



05-922



05-923

INFO/DIMENSIONS

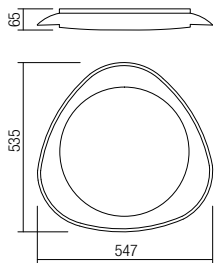
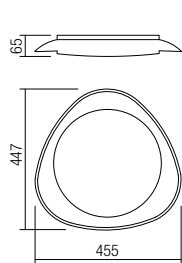

05-922

SMD LED · 24W
4000K · CRI 82
LED flux 2520 lm
Luminaire flux 1488 lm



05-923

SMD LED · 36W
4000K · CRI 82
LED flux 3850 lm
Luminaire flux 2088 lm



**DIFFUSER
WHIT
GLITTERING
EFFECT**



Knob



Ceiling lamps for indoor equipped with SMD LEDs warm white and cool white, variation of the color temperature from warm white to cool white by wall switch. Metal structure painted in mat white, mat black or mat gold, opal acrylic diffuser.

RO · Plafoniere pentru interior echipate cu LED-uri SMD alb cald și alb rece, permit setarea temperaturii de culoare a luminii de la alb cald la alb rece prin acționarea comutatorului. Structură din metal vopsit alb mat, negru mat sau auriu mat, dispersor din acril opal.

IT · Plafoniere per interni equipaggiate con LED SMD bianco caldo, bianco freddo, permetno la variazione della temperatura del colore, da bianco caldo a bianco freddo tramite il commutatore a parete. Struttura in metallo verniciato bianco opaco, nero opaco o oro opaco, diffusore in acrilico opale.

RU · Плафоны для интерьера, оснащенные светодиодами SMD, теплого белого и холодного белого цвета, настройка цветовой температуры от теплого белого до холодного белого цвета с помощью настенного выключателя. Металлическая структура, покрашенная в матовый белый, матовый черный или матовый золотистый цвет, акриловый рассеиватель опалового цвета.

HU · Beltéri mennyezeti lámpák, SMD LED-el szerelve, állítható színhőmérséklet meleg fehérről hideg fehérre kapcsoló segítségével. Matt fehér, matt fekete vagy matt arany fém szerkezet, akril opál diszperzór.

BG · Таванни осветления за интериор, оборудвани със SMD топло и студено бяло светодиоди. Метална структура, боядисана в матово бяло, матово черно или матово златно, дифузер от опалов акрилен.

SK · Interiérové stropné svietidlá vybavené SMD LED diódami teplá biela a studená biela, zmena teploty farby od teplej bielej po studenú bielu pomocou nástenného vypínača. Kovová konštrukcia lakovaná v matnej bielej, matnej čiernej alebo matnej zlatej farbe, opalový akrylový difúzor.



INFO/DIMENSIONS

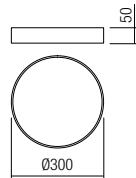

05-928 White
05-929 Gold
05-930 Black

SMD LED · 24W
 CCT 3000-6500K · CRI 80
 LED flux 2760 lm
 Luminaire flux 1380 lm

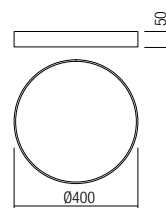

05-931 White
05-932 Gold
05-933 Black

SMD LED · 36W
 CCT 3000-6500K · CRI 80
 LED flux 4000 lm
 Luminaire flux 2180 lm





Dreamer



Wall/ceiling light fittings for interior equipped with SMD LEDs, metal structure painted in white, white acryl diffuser with glittering effect.

RO - Aplice/plafoniere pentru interior echipate cu LED-uri SMD, structură din metal vopsit alb, dispersor din acril alb cu efect de sclipire.

IT - Applique/plafoniere per interni equipaggiate con LED SMD, struttura in metallo verniciato bianco, diffusore in acrilico bianco finitura brillantata.

RU - Настенные/потолочные светильники для интерьера, оснащенные светодиодами SMD, металлическая структура окрашена в белый цвет, рассеиватель из белого акрила с блестящим эффектом.

HU - Beltéri fali/mennyezeti lámpák, SMD LED-el szerelve, fehér fém szerkezet, csillogó fehér akril diszperzór.

BG - Стенни/таванни осветления за интериор, разполагат със SMD светодиоди, метална структура боядисана в бяло, бял акрилен дифузер с блестящ ефект.

SK - Svietidlá na stenu/strop pre interiér vybavené LED diódami SMD, kovová konštrukcia lakovaná v bielej farbe, biely akrylový difúzor s trblietavým efektom.



05-906



05-907



05-908

DIFFUSER WHIT
GLITTERING EFFECT

INFO/DIMENSIONS

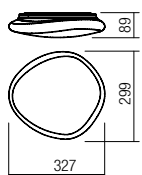

05-906

SMD LED · 18W · 4000K · CRI 85
LED flux 1800 lm
Luminaire flux 1200 lm

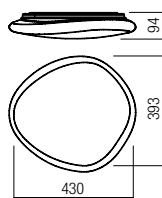

05-907

SMD LED · 36W · 4000K · CRI 85
LED flux 3750 lm
Luminaire flux 2500 lm

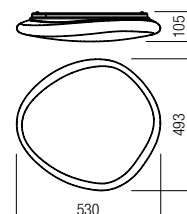

05-908

SMD LED · 46W · 4000K · CRI 85
LED flux 4900 lm
Luminaire flux 3250 lm





05-907

Emerald



Series of wall/ceiling light fittings for interior equipped with SMD LEDs, metal structure painted in white, white acryl diffuser with glittering effect.

RO · Serie de aplicie/plafoniere pentru interior echipate cu LED-uri SMD, structură din metal vopsit alb, dispersor din acril alb cu efect de sclipire.

IT · Serie di applique/plafoniere per interni equipaggiate con LED SMD, struttura in metallo verniciato bianco, diffusore in acrilico bianco finitura brillantata.

RU · Серия бра/потолочных светильников для интерьера, оснащенных светодиодами SMD, структура из металла окрашенного в белый цвет, рассеиватель из белого акрила со сверкающим эффектом.

HU · Beltéri fal/mennyezeti lámpák, SMD LED-el szerelve, fehér fémszerkezet, akril csillogó hatású diszperzór.

BG · Серия осветителни тела за стена/таван за интериор, оборудвани с SMD LED, метална конструкция, боядисана в бял, бял акрилен дифузьор с блестящ ефект.

SK · Sériu nástenných/stropných interiérových svietidiel, vybavených LED SMD diódami, kovová štruktúra lakovaná v bielej farbe, biely akrylový difúzor s trblietavým efektom.



INFO/DIMENSIONS

05-853 SMD LED · 18W 4000K · CRI 85 LED flux 1850 lm Luminaire flux 1461 lm	05-854 SMD LED · 24W 4000K · CRI 85 LED flux 2520 lm Luminaire flux 1956 lm	05-855 SMD LED · 32W 4000K · CRI 85 LED flux 3400 lm Luminaire flux 2584 lm

Hipno



Wall/ceiling light fittings for interior equipped with SMD LEDs, metal structure painted in white, white acrylic diffuser with grey decoration and glittering effect.

RO - Aplice/plafoniere pentru interior echipate cu LED-uri SMD, structură din metal vopsit alb, dispersor din acril alb cu decorațiune gri și efect de sclipire.

IT - Applique/plafoniere per interni equipaggiate con LED SMD, struttura in metallo verniciato bianco, diffusore in acrilico bianco con decorazione grigia e finitura brillantata.

RU - Бра/потолочные светильники для интерьера оснащенные светодиодами SMD, структура из металла окрашенного в белый цвет, рассеиватель из белого акрила с серыми украшениями и эффектом блеска.

HU - Beltéri fali/mennyezeti lámpatestek, SMD LED-el szerelve, fehér fémszerkezet, fehér akril diszperzör, csillogó szürke díszítéssel.

BG - Интериорно осветително тяло за монтаж на стена/таван, оборудвано с SMD диоди, метална основа, боядисана в бяло, бял дифузер със сива декорация и блестящ ефект.

SK - Nástenné a stropné svietidlá pre interiér vybavené LED diódami SMD, kovová konštrukcia lakovaná v bielej farbe, s bielym akrylovým difúzorom so sivou výzdobou a trblietavým efektom.



INFO/DIMENSIONS

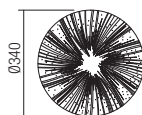
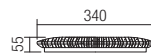

05-884
SMD LED · 18W · 4000K · CRI 85
LED flux 2000 lm
Luminaire flux 1410 lm

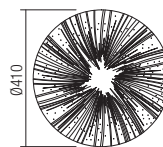
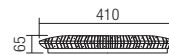

05-885
SMD LED · 24W · 4000K · CRI 85
LED flux 2520 lm
Luminaire flux 1796 lm

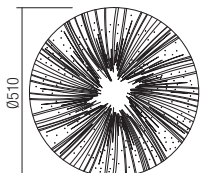
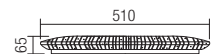

05-886
SMD LED · 36W · 4000K · CRI 85
LED flux 3850 lm
Luminaire flux 2655 lm



Flora



Wall/ceiling light fittings for interior equipped with SMD LEDs, metal structure painted in white, diffuser of patterned opal acryl with glittering effect, chromed central ornament.

RO · Aplice/plafoniere pentru interior echipate cu LED-uri SMD, structură din metal vopsit alb, dispersor din acril amprentat alb cu efect de sclipire, ornament central cromat.

IT · Applique/plafoniere per interni, equipaggiate con LED SMD, struttura in metallo verniciato bianco, diffusore stampato ad iniezione in acrilico bianco finitura brillantata, decorazione centrale cromata.

RU · Бра/потолочные светильники для интерьера, оснащенные светодиодами SMD, структура из металла окрашенного в белый цвет, рассеиватель из тесненного белого акрила со сверкающим эффектом, хромированным центральным орнаментом.

HU · Beltéri fal/mennyezeti lámpák, SMD LED-el szerelve, fehér fémszerkezet, akril csillogó hatású diszperzór, króm rögzítő elemekkel.

BG · Стени/таванни осветителни тела за интериор, оборудвани със SMD LED, метална конструкция боядисана в бяло, дифузьор от шарени акрил акрил с блестящ ефект, хромиран централен украшение.

SK · Nástenné/stropné interiérové svietidlá, vybavené LED SMD diódami, kovová štruktúra lakovaná v bielej farbe, difúzor v opálovom akryle s trblietavým efektom, s chrómovým centrálnym efektom.



INFO/DIMENSIONS

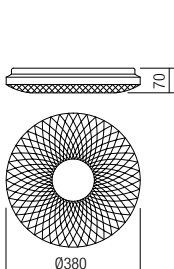

05-856
SMD LED · 24W · 4000K · CRI 85
LED flux 2520 lm
Luminaire flux 1956 lm

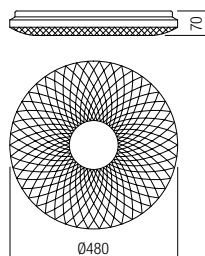

05-857
SMD LED · 32W · 4000K · CRI 85
LED flux 3400 lm
Luminaire flux 2584 lm



Tetris



Wall/ceiling light fittings for interior, equipped with SMD LEDs, metal structure painted in white, shade of transparent acryl with diamond pattern edge, white plastic diffuser with glittering effect.

RO · Aplice/plafoniere pentru interior, echipate cu LED-uri SMD, structură din metal vopsit alb, abajur din acril transparent amprentat, model diamant și dispersor din plastic alb cu efect de sclipire.

IT · Applique/plafoniere per interni, equipaggiate con LED SMD, struttura in metallo verniciato bianco, paralume stampato ad iniezione in acrilico trasparente, modello diamante, diffusore in plastica bianca finitura brillantata.

RU · Бра/потолочные светильники для интерьера, оснащенные светодиодами SMD, структура из металла окрашенного в белый цвет, абажур из прозрачного акрила в форме бриллиантов и рассеиватель из белого пластика с переливающимся эффектом.

HU · Beltéri fali/mennyezeti világítótestek, SMD LED-el ellátva, fehér fémszerkezet, áttetsző akril ernyővel, csillogó hatású műanyag fehér diszperzor.

BG · Интериорни аплици/плафаниери, оборудвани с SMD LED-ове, структура от метал боядисан в бяло, абажур от прозрачен акрил с отпечатьци, модел диамант и разсейвател от бяла пластмаса с мигащ ефект.

SK · Sériá nástenných a stropných interiérových svietidiel s LED SMD diódami, kovová biela štruktúra, tienidlá z priehľadného akrylu s blikajúcim efektom.



05-844



05-846

INFO/DIMENSIONS

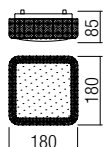

05-844

SMD LED · 12W
4000K · CRI 82
LED flux 1280 lm
Luminaire flux 876 lm

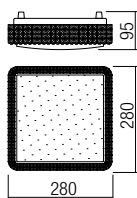

05-845

SMD LED · 18W
4000K · CRI 82
LED flux 1850 lm
Luminaire flux 1278 lm

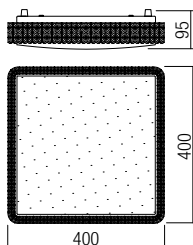

05-846

SMD LED · 22W
4000K · CRI 82
LED flux 2280 lm
Luminaire flux 1606 lm



Aragon

Ceiling lamps for interior equipped with SMD LEDs, metal structure painted in white, white acrylic diffuser with glittering effect and central transparent decoration.

RO · Plafoniere pentru interior echipate cu LED-uri SMD, structură din metal vopsit alb, dispersor din acril alb cu efect de scîlpire și decorațiune centrală transparentă.

IT · Plafoniere per interni equipaggiate con LED SMD, struttura in metallo verniciato bianco, diffusore in acrilico bianco finitura brillantata con decorazione centrale trasparente.

RU · Потолочные светильники для интерьера, оснащенные светодиодами SMD, металлическая структура, окрашенная в белый цвет, белый акриловый рассеиватель с блестящим эффектом и центральной прозрачной отделкой.

HU · SMD LED-ekkel felszerelt beltéri mennyezeti lámpa, fehérre festett fémstruktúra, csillogó hatású fehér akril fényzóró, krómozott díszelemekkel.

BG · Тавани осветления за интериор, оборудвани със SMD светодиоди, метална структура боядисана в бяло, бял акрилен дифузер с блестящ ефект и централна прозрачна декорация.

SK · Interiérové stropné svietidlá vybavené LED diódami SMD, kovovou štruktúrou lakovaná v bielej farbe, bielym akrylovým difúzorom s lešteným povrchom a priehľadnou centrálnou dekoráciou.



05-914



05-916

INFO/DIMENSIONS

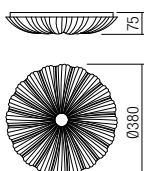

05-914

SMD LED · 24W · 4000K · CRI 85
LED flux 2520 lm
Luminaire flux 1824 lm

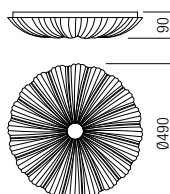

05-915

SMD LED · 36W · 4000K · CRI 85
LED flux 3850 lm
Luminaire flux 2556 lm

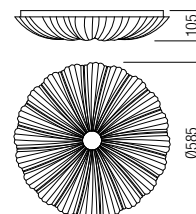

05-916

SMD LED · 48W · 4000K · CRI 85
LED flux 5200 lm
Luminaire flux 3648 lm





05-915

Brille



Series of wall/ceiling light fittings for interior, equipped with SMD LEDs, metal structure painted in white, injection molded diffuser of transparent acryl with diamond pattern, white plastic diffuser.

RO · Serie de aplici/plafoniere pentru interior, echipate cu LED-uri SMD, structură din metal vopsit alb, abajur din acril transparent amprentat model diamant și dispersor din plastic alb.

IT · Serie di applique/plafoniere per interni, equipaggiate con LED SMD, struttura in metallo verniciato bianco, paralume stampato ad iniezione in acrilico trasparente, modello diamante, diffusore in plastica bianca.

RU · Серия настенных/потолочных светильников для интерьера, оснащенных светодиодами SMD, металлическая структура, окрашенная в белый цвет, рассеиватель из прозрачного акрила с алмазным тиснением и белый пластиковый рассеиватель.

HU · Beltéri fali/mennyezeti lámpatestek, SMD LED-el szerelve, attetsző akril gyémánt mintás ernyővel és fehér műanyag diszperzór.

BG · Серия интериорни аплици/плафониери оборудвани със SMD LED-ове, структура от метал боядисан в бяло, абажур от прозрачен акрил с отпечатъци модел диамант и разсейвател от бяла пластмаса.

SK · Séria interiérových nástenných/stropných svietidiel, vybavená LED SMD diódami, kovová konštrukcia v bielej farbe, difúzor z priehľadného akrylu s diamantovým vzorom.



INFO/DIMENSIONS

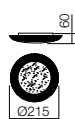

05-850

SMD LED · 12W · 4000K · CRI 82
LED flux 1180 lm
Luminaire flux 967 lm



05-851

SMD LED · 12W · 4000K · CRI 82
LED flux 1180 lm
Luminaire flux 967 lm

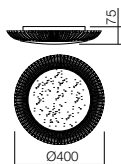

05-852

SMD LED · 24W · 4000K · CRI 82
LED flux 2500 lm
Luminaire flux 1975 lm



Kuna



Series of wall/ceiling light fittings for interior, equipped with SMD LEDs, metal structure painted in white, injection molded diffuser of transparent acryl, crystal effect.

RO · Serie de aplicie/plafoniere pentru interior, echipate cu LED-uri SMD, structură din metal vopsit alb, dispersor din acril transparent amprentat efect cristal.

IT · Serie di applique/plafoniere per interni, equipaggiate con LED SMD, struttura in metallo verniciato bianco, paralume stampato ad iniezione in acrilico trasparente, effetto cristallo.

RU · Серия настенных/потолочных светильников для интерьера, оснащенных светодиодами SMD, металлическая конструкция, окрашенная в белый цвет, рассеиватель из прозрачного акрила с кристаллическим эффектом.

HU · Beltéri falikar/mennyezeti, SMD LED-el ellátva, fehér fémszerkezet, kristályos hatású áttetsző akril diszperzör.

BG · Серия интериорни аплици/плафонiere оборудвани със SMD LED-ове, струкура от метал боядисана в бяло, инжекционно формован разсейвател от прозрачен акрил с кристален ефект.

SK · Sériá interiérových nástenných/stropných svietidiel, vybavených LED SMD diódami, kovová konštrukcia biela, difúzor z priehľadného akrylu s kryštálovým efektom.



INFO/DIMENSIONS



05-847
SMD LED · 12W · 4000K · CRI 82
LED flux 1180 lm
Luminaire flux 873 lm

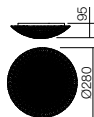

05-848
SMD LED · 12W · 4000K · CRI 82
LED flux 1180 lm
Luminaire flux 873 lm

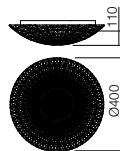

05-849
SMD LED · 24W · 4000K · CRI 82
LED flux 2500 lm
Luminaire flux 1825 lm



Lucino

Ceiling lamp for interior, equipped with SMD LEDs, metal structure painted in white, white acryl diffuser with glittering effect, central decoration and chromed ornaments.



RO · Plafonieră pentru interior, echipată cu LED-uri SMD, structură din metal vopsit alb, dispersor din acril alb cu efect de sclipire, decorațiune centrală și ornamente cromate.

IT · Plafoniera per interni, equipaggiata con LED SMD, struttura in metallo verniciato bianco, diffusore in acrilico bianco finitura brillantata, decorazione centrale trasparente e ornamenti cromati.

RU · Потолочный светильник для интерьера, оснащенный светодиодами SMD, металлическая структура, окрашенная в белый цвет, рассеиватель из белого акрила с блестящим эффектом, центральное украшение и орнаменты хромированы.

HU · SMD LED-ekkel felszerelt beltéri mennyezeti lámpa, fehérre festett fémstruktúra, csillogó hatású fehér akril fényoszóró, krómozott díszelemekkel.

BG · Таванно осветление за интериор, оборудвано със SMD светодиоди, метална структура, боядисана в бяло, бял акрилен дифузер с блестящ ефект, централна декорация и хромирани украси.

SK · Interiérové stropné svietidlo, vybavené SMD LED, kovovou štruktúrou lakovanou v bielej farbe, bielym akrylovým difúzorom s lešteným povrchom, priehľadnou centrálnou dekoráciou a chrómovanými ornamentami.



05-913



DIFFUSER WHIT GLITTERING EFFECT



05-912

INFO/DIMENSIONS

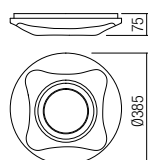

05-912

SMD LED · 24W · 4000K · CRI 85
LED flux 2520 lm
Luminaire flux 1794 lm

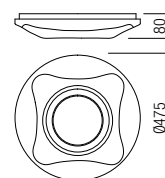

05-913

SMD LED · 36W · 4000K · CRI 85
LED flux 3850 lm
Luminaire flux 2592 lm



Odiseea



Series of wall lamps and ceiling lamps for interior equipped with SMD LEDs, metal structure painted in white, mirrored glass frame and screen printed glass diffuser with central crystal decoration, fixing element of chromed metal.

RO · Serie de aplicе și plafoniere pentru interior echipate cu LED-uri SMD, structură din metal vopsit alb, cornișă din sticlă oglindată și dispersor din sticlă serigrafată cu decorațiune centrală din cristale, accesorii de fixare din metal cromat.

IT · Serie di applique e plafoniere per interni equipaggiate con LED SMD, struttura in metallo verniciato bianco, cornice in vetro specchiato e diffusore in vetro serigrafato bianco con decorazione centrale in cristalli, accessori di fissaggio in metallo cromato.

RU · Серия бра/потолочных светильников для интерьера, оснащенные светодиодами SMD, металлическая структура, окрашена в белый цвет, рама из зеркального стекла и рассеиватель из стекла с трафаретной печатью и центральной отделкой из хрустала, крепежный элемент из хромированного металла.

HU · Beltéri falí/mennyezeti lámpák, SMD LED-el szerelve, fehér fém szerkezet, színtanymású fehér üveg diszperzór, kristály díszítéssel, króm rögzítő elemekkel.

BG · Серия стени лампи и таванни осветителни тела за интериора, разполагат със SMD светодиоди, метална структура боядисана в бяло, корниз от огледално стъкло и дифузер от ситопечатно стъкло, с централна кристална декорация, фиксиращи аксесоари от хромиран метал.

SK · Sériа nástenných/stropných interiérových svietidiel, vybavených LED SMD diódami, kovová konštrukcia lakovaná bielou farbou, zrkadlový sklenený rám a sklenený difúzor so sietotlačou s dekoráciou z krištáľu, upevňovací prvok z chrómovaného kovu.



05-911

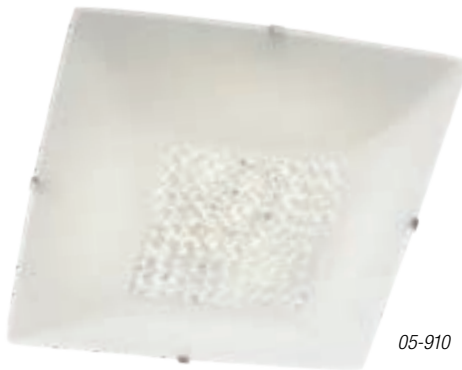

05-910



05-909

INFO/DIMENSIONS

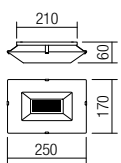

05-909
SMD LED · 10W
4000K · CRI 82
LED flux 950 lm
Luminaire flux 740 lm

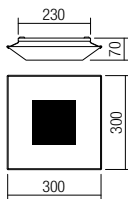

05-910
SMD LED · 12W
4000K · CRI 82
LED flux 1300 lm
Luminaire flux 904 lm

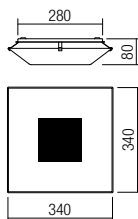

05-911
SMD LED · 18W
4000K · CRI 82
LED flux 1850 lm
Luminaire flux 1314 lm



Cocoon



Series of interior light fittings, metal structure painted in white/satin nickel metal, diffuser of glass with screen printed white decoration and embellished with glass beads, chromed fixing elements.

RO · Serie de corpuri de iluminat pentru interior, structură din metal vopsit alb/metal nichelat, dispersor din sticlă cu decor serigrafat alb și ornat cu granule din sticlă, elemente de fixare cromate.

IT · Serie di lampade per interni, struttura in metallo verniciato bianco/metallo nichel opaco, diffusore in vetro serigrafato bianco e decorato con graniglia, elementi di fissaggio cromati.

RU · Серия светильников для интерьера, структура из металла окрашенного в белый/никелированный металл, рассеиватель из стекла с напечатанным белым рисунком и украшенный стеклянными гранулами, хромированные крепежные элементы.

HU · Beltéri világítótestek, fehér/nickel fémszerkezet, üveg diszpezőr üveg granulátum diszítéssel, króm rögzítő elemekkel.

BG · Серия интериорни осветителни тела, конструкция от метал боядисани в бял/сатен никел метал, стъклен дифузер със ситопечат и бяла украса и украсени със стъклени перли, хромирани фиксиращи елементи.

SK · Sériá interiérových svietidiel, kovová konštrukcia lakovaná v bielej a chrómovej farbe, sklenené difúzory s kryštálovou výzdobou, upevňovacie prvky v chróme.



05-877



05-873



05-876

INFO/DIMENSIONS

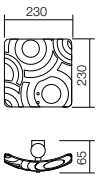

05-873

E27, 1 x max. 42W

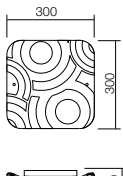

05-874

E27, 1 x max. 42W

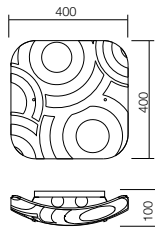

05-875

E27, 2 x max. 42W

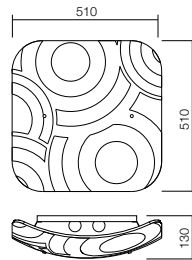

05-876

E27, 3 x max. 42W

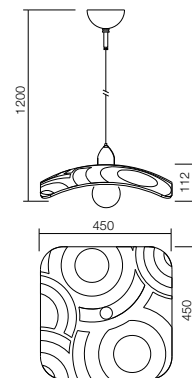

05-877

E27, 1 x max. 42W



Sektor



Series of lamps for interior, metal structure painted in white, glass diffuser with screen printed white decoration embellished with glass beads, chromed fixing elements.

RO - Serie de lămpi pentru interior, structură din metal vopsit alb, dispersor din sticlă cu decor serigrafat alb și ornat cu granule din sticlă, elemente de fixare cromate.

IT - Serie di lampade per interni, struttura in metallo, verniciata a polveri bianco, diffusore in vetro serigrafato bianco e decorato con graniglia, elementi di fissaggio cromati.

RU - Серия светильников для внутреннего освещения, структура из металла окрашенного в белый цвет, рассеиватель из стекла с напечатанным белым рисунком и украшенный стеклянными гранулами, крепление из хромированного металла.

HU - Beltéri lámpasor, fehér fémszerkezet, üveg diszpezór üveg granulátum díszítéssel, króm rögzítő elemekkel.

BG - Серия интериорни лампи, метална конструкция, боядисана в бяло, стъклен дифузор със ситопечат, бяла декорация, украсена със стъквени перли, хромирани фиксиращи елементи.

SK - Rad interiérových svietidiel, vybavených LED SMD diódami, kovová štruktúra lakovaná v bielej farbe, sklenený difúzor s bielymi dekoráciami, so sklenenými korálikmi, upevňovacie prvky v chróme.



05-871

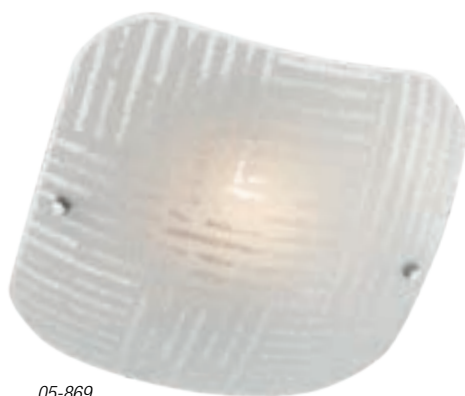

05-869



05-870

INFO/DIMENSIONS

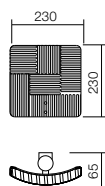

05-868

E27, 1 x max. 42W

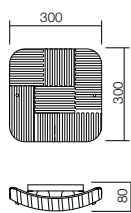

05-869

E27, 1 x max. 42W

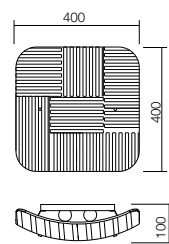

05-870

E27, 2 x max. 42W

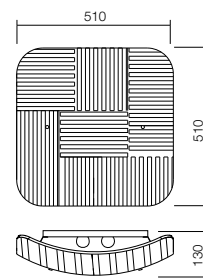

05-871

E27, 3 x max. 42W

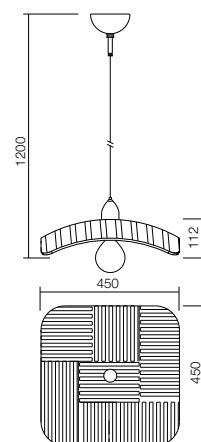

05-872

E27, 1 x max. 42W





05-870

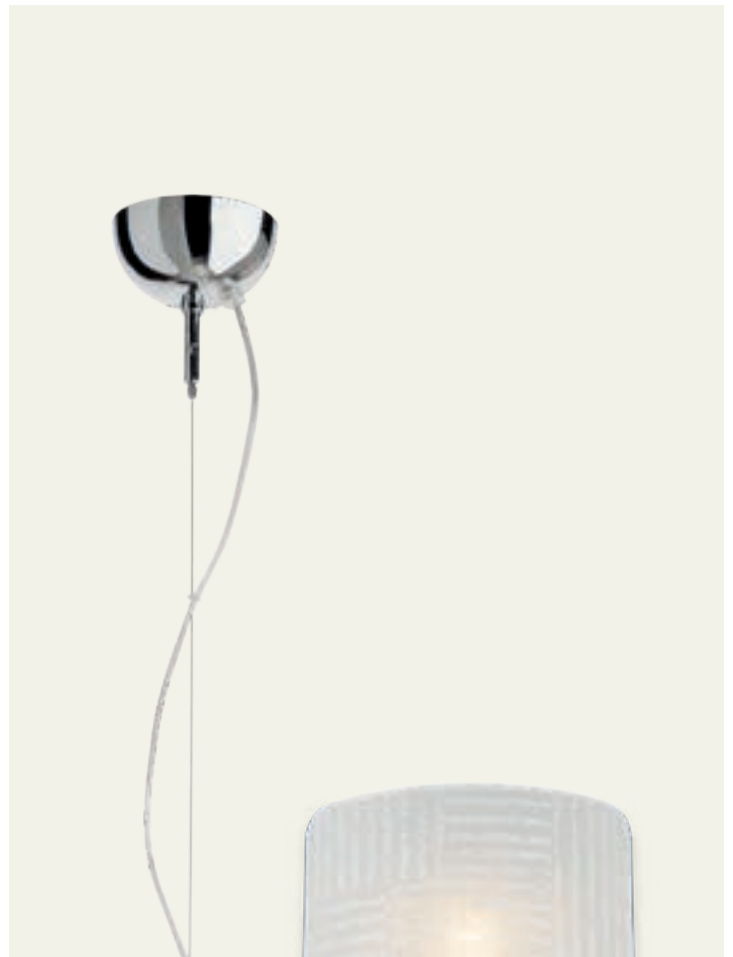

05-868



05-872



05-872



Lamps for interior, metal structure painted in white, diffuser of glass with screen printed white decoration and embellished with glass beads, chromed fixing elements.

RO · Corpuri de iluminat pentru interior, structură din metal vopsit alb, dispersor din sticlă cu decor serigrafat alb și ornate cu granule din sticlă, elemente de fixare cromate.

IT · Apparecchi per interni struttura in metallo, verniciata a polveri bianco, diffusore in vetro serigrafato bianco e decorato con graniglia, elementi di fissaggio cromati.

RU · Светильники для интерьера, металлическая структура, окрашенная в белый цвет, рассеиватель из стекла с трафаретной печатью белого цвета, украшенный стеклянными бусинами, хромированные элементы крепления.

HU · Beltéri lámpatestek, fehér fém szerkezet, szitanyomású fehér üveg diszperzór, üvegszemcsés díszítéssel, króm rögzítő elemekkel.

BG · Осветителни тела за интериор, метална структура боядисана в бяло, стъклен дифузер със ситопечатна декорация, украсен със стъкленни гранули, хромирани фиксиращи елементи.

SK · Svietidlá do interiéru, kovová konštrukcia lakovaná bielou farbou, difúzor zo skla s potlačou bielej dekorácie a ozdobený sklenenými perličkami, pochrómované upevňovacie prvky.

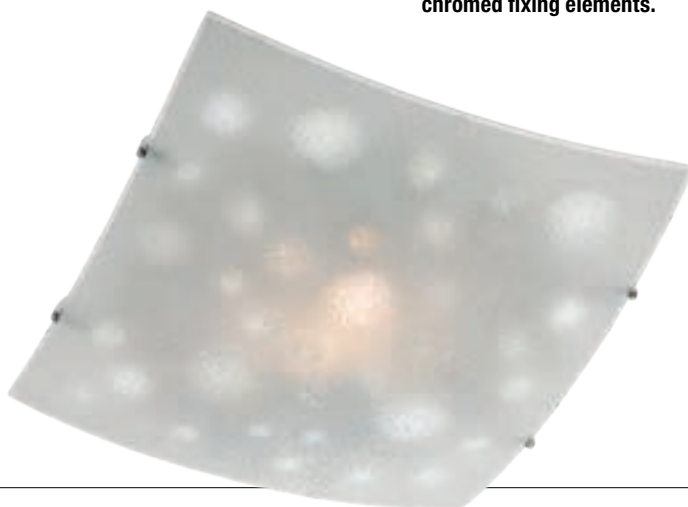

05-904

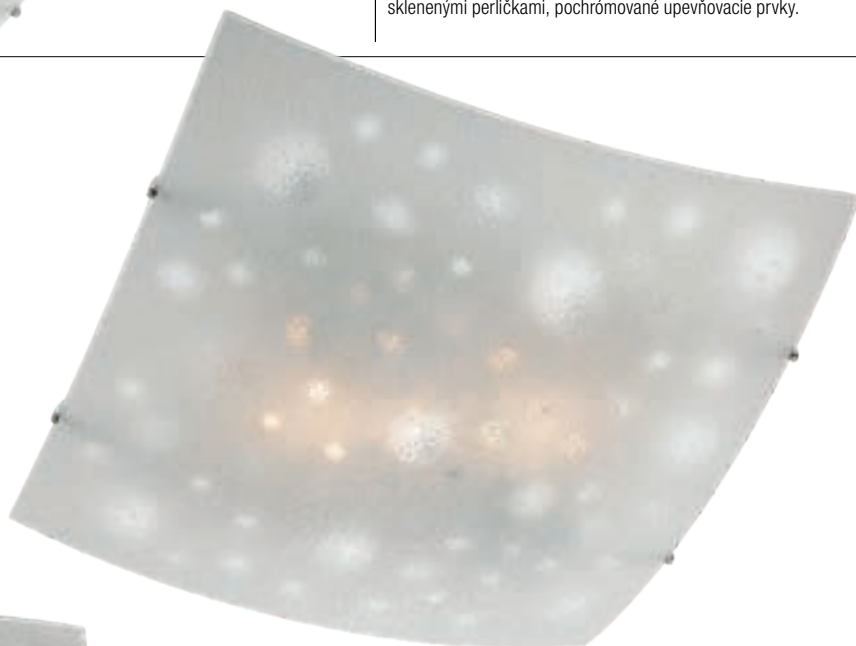

05-905



05-903

INFO/DIMENSIONS

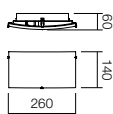
**05-903**

E27, 1 x max. 42W

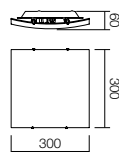
**05-904**

E27, 1 x max. 42W

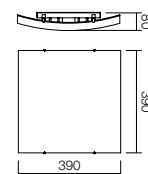
**05-905**

E27, 2 x max. 42W





05-904

Sunny

Ceiling lamps for indoor, metal structure painted in white, screen printed glass diffuser decorated with glass granules, chrome fixing element.



05-841



05-840

RO - Plafoniere pentru interior, structură din metal vopsit alb, dispersor din sticlă serigrafată și decorată cu granule de sticlă, cu element de fixare cromat.

IT - Plafoniere per interni, struttura verniciata a polveri bianco, diffusore in vetro serigrafato decorato con graniglia, elementi di fissaggio cromati.

RU - Потолочные светильники для внутреннего освещения, металлическая конструкция, окрашенная в белом цвете, диффузор из сериграфированного стекла с украшениями из стеклянных бусин, с хромированным крепежным элементом.

HU - Beltéri mennyezeti lámpa, fehérre festett fémszerkezettel, krómozott rögzítőelemmel ellátott, üveggranulátummal díszített, szitanyomatos üveg diszperzórral.

BG - Интериорни плафониери, структура от метал, боядисан в бяло, разсейвател от сериграфирано стъкло и украсено със стъквени перли, с хромиран закрепващ елемент.

SK - Stropné svetidlá pre interiér, kovová konštrukcia lakovaná vo farbe bielej, sietotlačovaným sklenným difúzorom zdobeným sklennými granulami, s upevňovacím chrómovým prvkom.

INFO/DIMENSIONS

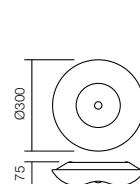
**05-840**

E27, 2 x max. 42W

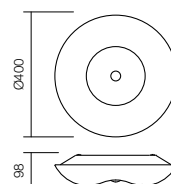
**05-841**

E27, 3 x max. 42W



Shake



Series of interior light fittings, printed glass diffuser, metal structure electrostatically painted in white, chromed fixing elements.

RO - Serie de lămpi pentru interior, dispersor din sticlă serigrafată, structură din metal vopsit în câmp electrostatic culoare albă, elemente de fixare cromate.

IT - Serie di lampade per interni, diffusore in vetro serigrafato, struttura di metallo verniciato a polveri bianco, elementi di fissaggio cromati.

RU - Серия светильников для внутреннего освещения, диффузор из сериграфированного стекла, металлическая структура, окрашенная в электростатическом поле белого цвета, хромированные крепежные элементы.

HU - Beltéri lámpasor szitanyomatos üveg diszperzórral, elektrosztatikus mezőben fehérre festett fémszerkezettel, krómzott rögzítő elemekkel.

BG - Серия интериорни лампи, разсейвател от сериграфирано стъкло, структура метал боядисан в электростатично поле, бял цвят, хромирани фиксиращи елементи.

SK - Rad interiérových svetidiel, tlačný sklenený difúzor, kovová konštrukcia maľovaná v elektrostatickom poli v bielej farbe, s chrómovanými upevňovacími prvkami.

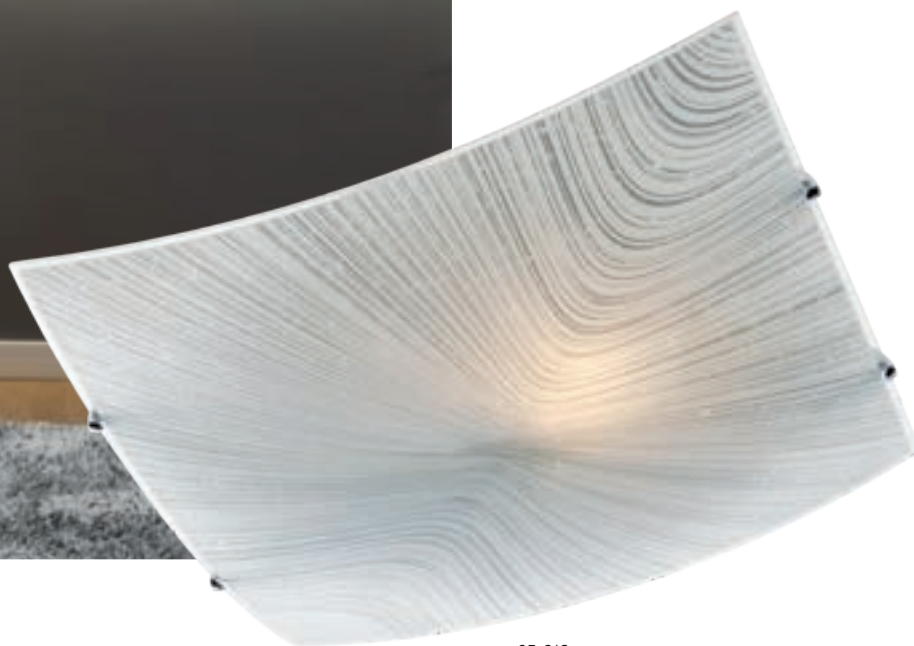

05-813



05-811

INFO/DIMENSIONS

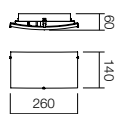
**05-811**

E27, 1 x max. 42W

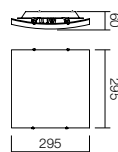
**05-812**

E27, 1 x max. 42W

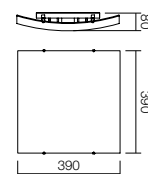
**05-813**

E27, 2 x max. 42W



Selene



Series of lamps with white screen printed glass diffuser, metal structure painted in white with chromed fixing accessories of the glass.

RO · Serie de lămpi cu dispersor din sticlă serigrafată albă, structură din metal vopsit alb cu accesorii cromate de fixare a sticlei.

IT · Serie di lampade con diffusore in vetro serigrafato bianco e struttura di metallo verniciato in bianco con accessori cromati di fissaggio del vetro.

RU · Серия светильников с диффузором из сериграфированного стекла, металлическая конструкция, окрашенная в белом цвет, или конструкция из сатинированного никеля, с хромированными элементами для крепления стекла.

HU · Világítótest sorozat szitanyomatos üveg diszperzórral, fehérre festett vagy szatinált nikkelt fémszerkezettel, az üveg rögzítésére szolgáló krómozott rögzítő-elemekkel.

BG · Серия осветителни тела с разсейвател от сериграфирано стъкло и структура от метал, боядисан в бяло или сатениран никел с хромирани аксесоари за фиксиране на стъклото.

SK · Sériá lămp s bielym sietotlačovým skleneným difúzorom, kovová konštrukcia maľovaná v bielej farbe s chrómovaným príslušenstvom.



05-567

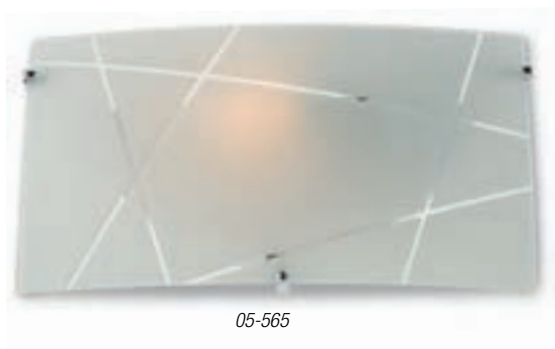

05-565



INFO/DIMENSIONS

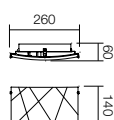

05-565

E27, 1 x max. 42W

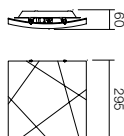

05-566

E27, 1 x max. 42W

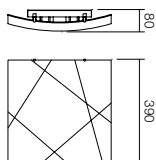

05-567

E27, 2 x max. 42W



Kate

Indoor lamps, white metal structure with chrome details, screen printed glass diffuser.

RO · Serie de corpuri de iluminat pentru interior, structură din metal vopsit alb cu detalii cromate, dispersor din sticlă serigrafată.

IT · Serie di lampade per interni, struttura in metallo verniciato bianco con dettagli cromati, diffusore in vetro serigrafato.

RU · Серия осветительных тел для внутреннего освещения, структура из металла, крашенного в белый цвет, с хромированными деталями, диффузор из сериграфированного стекла.

HU · Világító testek sorozat belső számára, krómozott részletű fehérre festett fém szerkezet, szerigrafált üveg diszperzór.

BG · Серия вътрешни осветителни тела, структура от бяло боядисан метал с хромирани детайли, разпръсквач от сериграфирано стъкло.

SK · Interiérové lampy, biela kovová konštrukcia s chrómovanými detailmi, sietotlačové sklo difúzora.

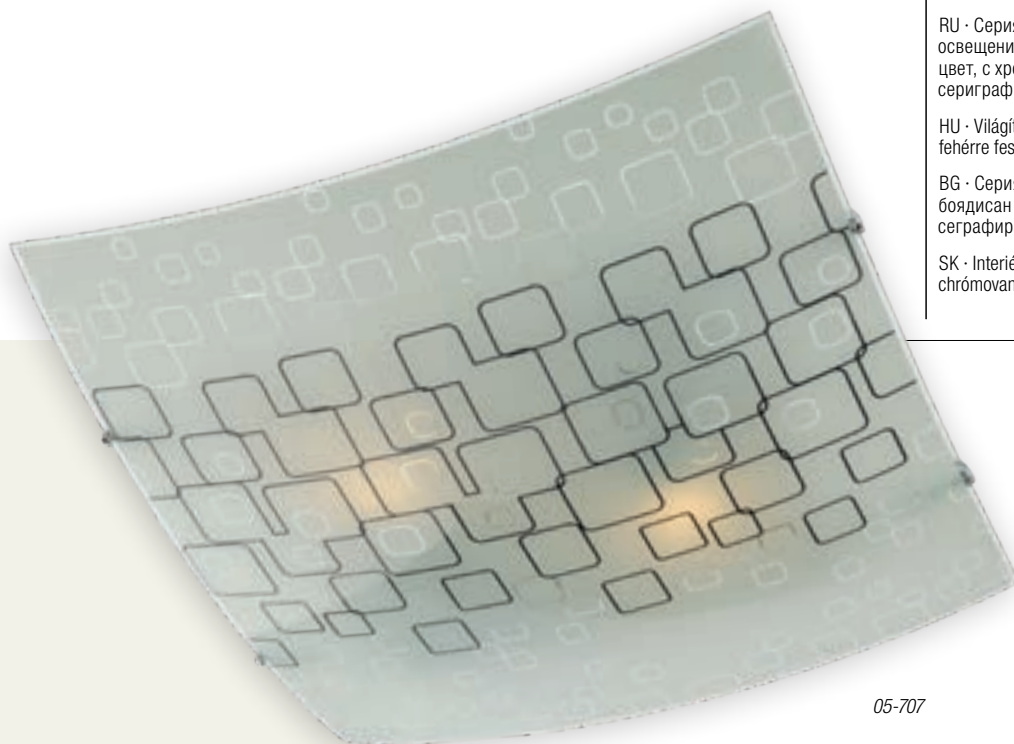

05-707



05-705

INFO/DIMENSIONS

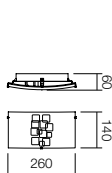

05-705

E27, 1 x max. 42W

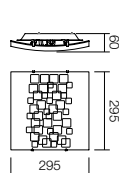

05-706

E27, 1 x max. 42W

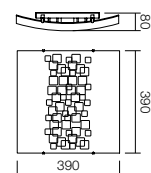

05-707

E27, 2 x max. 42W





Series of light fixtures for interior equipped with SMD LEDs, metal structure painted in white, screen printed glass diffuser with silver or gold foil application and central crystal decoration, fixing element of chromed metal.

RO · Corpuri de iluminat pentru interior echipate cu LED-uri SMD, structură din metal vopsit alb, abajur din sticlă serigrafată cu aplicație foiță argint sau aur și decorațiune centrală din cristale, accesorii de fixare din metal cromat.

IT · Apparecchi per interni equipaggiati con LED SMD, struttura in metallo verniciato bianco, diffusore in vetro serigrafato bianco con applicazione foglia argento oppure oro e decorazione centrale in cristalli, accessori di fissaggio in metallo cromato.

RU · Серия светильников для интерьера, оснащенных светодиодами SMD, металлическая структура окрашена в белый цвет, стеклянный диффузор с трафаретной печатью с серебряной или золотой фольгой и хрустальной центральной отделкой, крепежные элементы из хромированного металла.

HU · Beltéri lámpatestek, SMD LED-el szerelve, fehér fém szerkezet, szitanyomású fehér üveg diszperzór, ezüst vagy arany fólia díszítéssel és króm kötőelemekkel.

BG · Осветителни тела за интериор, разполагат със SMD светодиоди, метална структура боядисана в бяло, екранен стъклен абажур със сребърна или златна фолио и централна украса от кристал, фиксиращи аксесоари от хромиран метал.

SK · Sériá svietidiel do interiéru vybavených LED diódami SMD, kovová konštrukcia lakovaná bielou farbou, sklenený sieťotlač so striebornou alebo zlatou fóliou a krištáľovou dekoráciou, upevňovací prvok z chrómovaného kovu.

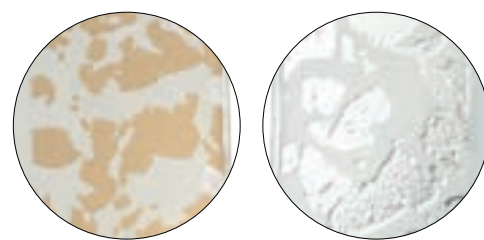

GOLD FOIL

SILVER FOIL

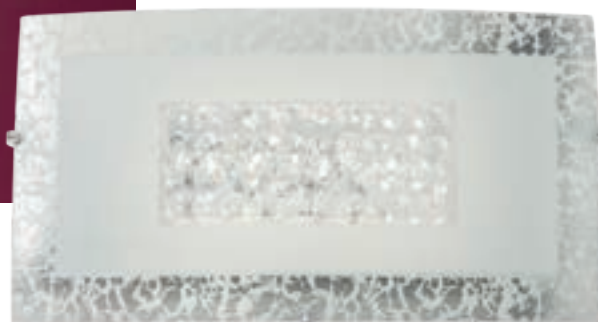

05-896

INFO/DIMENSIONS

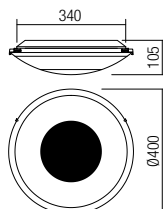
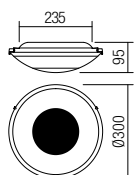
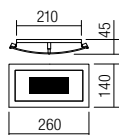

● 05-895 Gold
● 05-896 Silver

SMD LED · 10W · 4000K · CRI 85
LED flux 950 lm
Luminaire flux 756 lm



● 05-897 Gold
● 05-898 Silver

SMD LED · 12W · 4000K · CRI 85
LED flux 1300 lm
Luminaire flux 904 lm



● 05-899 Gold
● 05-900 Silver

SMD LED · 18W · 4000K · CRI 85
LED flux 1850 lm
Luminaire flux 1325 lm





05-899



05-898



05-897

Virginia



Series of lamps with alabaster glass diffuser available in several colors: white and tobacco and metal structure painted in white with chrome or brown clips. The suspensions have adjustable height mount in white or gold plastic.

RO · Serie de lămpi cu dispersor din sticlă tip alabastru în variante de culori: alb și tabac și structură din metal vopsit alb cu cleme cromate sau brunate. Suspensiile au montură din plastic alb sau auriu cu înălțime reglabilă sau fixă.

IT · Serie di lampade con diffusore in vetro di tipo alabastro in diversi colori: bianco e tabacco e struttura di metallo verniciato in bianco con morsetti cromati o marroni. Le sospensioni hanno la montatura di plastica bianca o dorata con altezza regolabile o fissa.

RU · Серия ламп с диффузором из стекла типа алебастра в разных цветовых вариантах: белого и табачного цвета. Металлическая структура, окрашенная в белый цвет, с хромированными или воронеными скобами. Обделка подвесок сделаны из белого или золотистого пластика с подвижной или неподвижной высотой.

HU · Alabástrom típusú üvegből készült diszperzoros lámpák sorozat, különböző színekkel: fehér vagy tabak és fehérre festett fém szerkezet, krómozott vagy barna fogokkal. A felfüggesztések fehér vagy aranyos műanyagból való merev vagy beállítható magasságú.

BG · Серия лампи със стъклен разпръсквач вид алабастр във варианти за цветове: бяло или тютюн и бяло боядисано метална структура с хромирани или кафяви боядисани щипки. Окачванията имат рамка от бяла или златна пластмаса с регулируема или фиксирана височина.

SK · Sériá lămp so skleneným difúzorom alabaster vo farebných variantách: biela alebo tabak a kovová konštrukcia v bielej farbe s chrómom alebo hnedými svorkami. Zavesenie má pevnú súčasť zo zlatého plastu s nastaviteľnou výškou.



05-677



05-378

INFO/DIMENSIONS

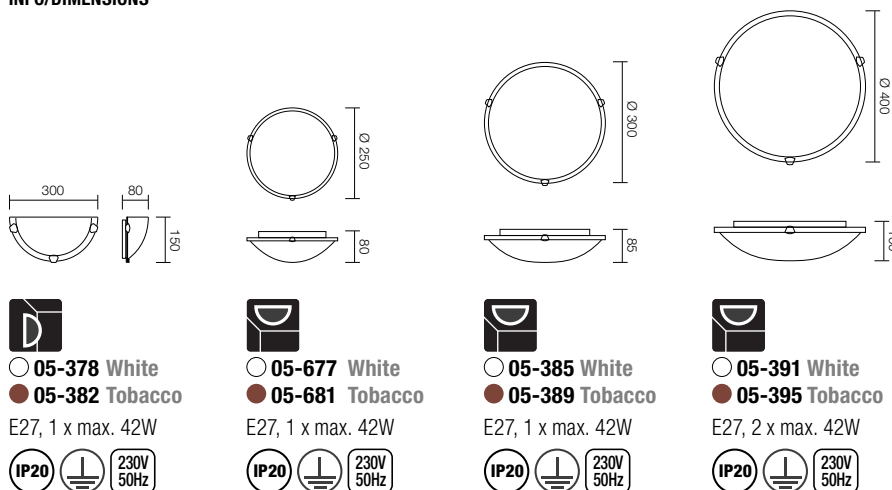

○ 05-378 White
● 05-382 Tobacco
E27, 1 x max. 42W



○ 05-677 White
● 05-681 Tobacco
E27, 1 x max. 42W



○ 05-385 White
● 05-389 Tobacco
E27, 1 x max. 42W



○ 05-391 White
● 05-395 Tobacco
E27, 2 x max. 42W



White ○

Tobacco ●



Virginia



05-369



05-366

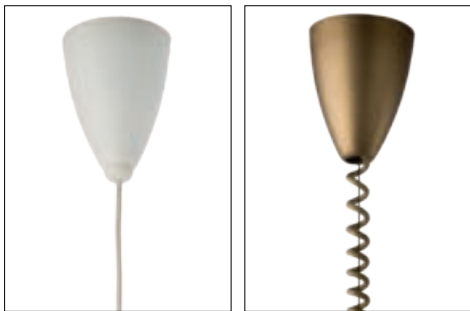

FIXED WIRE

MOBILE WIRE

INFO/DIMENSIONS

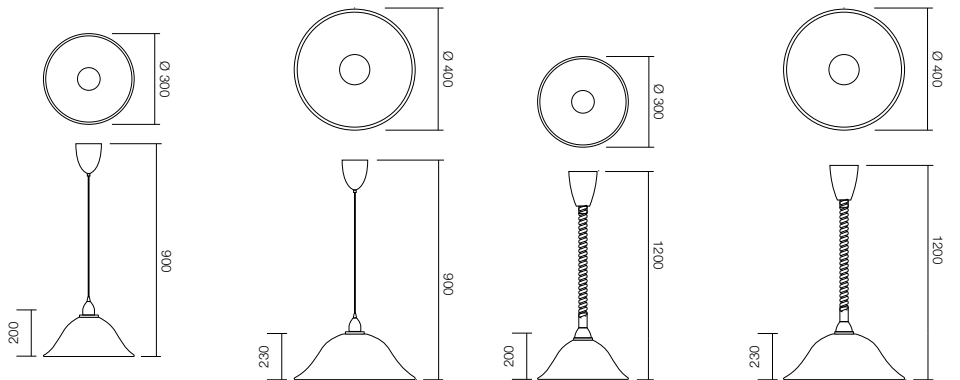

 Fixed Wire
 ○ 05-364 White
 ● 05-365 Tobacco

E27, 1 x max. 42W



 Fixed Wire
 ○ 05-366 White
 ● 05-367 Tobacco

E27, 1 x max. 42W



 Mobile Wire
 ○ 05-368 White
 ● 05-369 Tobacco

E27, 1 x max. 42W



 Mobile Wire
 ○ 05-370 White
 ● 05-371 Tobacco

E27, 1 x max. 42W





05-365

Tavel



Ceiling lamp for interior, structure of metal painted in white and natural or graphite finished beech wood, white screen printed diffuser.

RO · Plafoniere pentru interior, structură din metal vopsit alb și lemn de fag natur sau finisat gri grafit, dispersor din sticlă serigrafată.

IT · Plafoniera per interni, struttura in metallo verniciato bianco e legno di faggio naturale o con finitura grigio grafito, diffusore in vetro serigrafato bianco.

RU · Потолочные светильники для интерьера, структура из металла окрашенного в белый цвет и натурального букowego дерева или букowego дерева с графитовой отделкой, рассеиватель из стекла с трафаретной печатью.

HU · Beltéri mennyezeti lámpatestek, fehér fémszerkezet, natúr tölgy vagy grafit színben, szitázott üveg diszperzór.

BG · Плафон, метална основа, боядисана в бяло и натурален бук с графитен завършек, бял дифузер.

SK · Stropné svetidlo pre interiér, štruktúra kovu lakovaná bielej farbe a prírodnej z grafitu z bukového dreva, biely difúzor.



05-882



05-881

INFO/DIMENSIONS

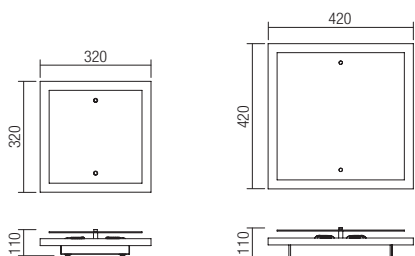

● 05-880 Natural
● 05-881 Graphite

E27, 2 x max. 42W



● 05-882 Natural
● 05-883 Graphite

E27, 4 x max. 42W





05-882



Series of lamps with ayous wood cornice finished in mahogany or walnut with burnished details, white alabaster glass diffuser.

RO · Colecție de lămpi cu cornișă din lemn de ayous în variante de finisaje: mahon sau nuc cu detalii brunate, dispersor sticlă alabastru alb.

IT · Serie di lampade con cornice di legno di ayous in varianti di finitura: mogano, noce con dettagli marroni, diffusore di vetro bianco alabastro.

RU · Серия светильников с деревянным карнизом Аюса, варианты отделочного слоя: акажу или грецкий орех с воронеными деталями; стеклянный диффузор из алебаstra белого цвета.

HU · Ayousfából készült kornisos lámpák gyűjtemény mahagóni vagy diófa kivitelben, barna részletekkel, fehér alabástrom üveg diszperzór.

BG · Колекция лампи с дървен корниз от айоус, с варианти за покритие: махагон или орех с по-брунирани детайли, бял алабастр разпръсквач.

SK · Rad interiérových svietidiel s Ayous drevenou obrubou vo variantach: mahagón alebo orech s hnedými detailami, biely alabastrový sklenené difúzor.



05-089



05-091



05-085

INFO/DIMENSIONS

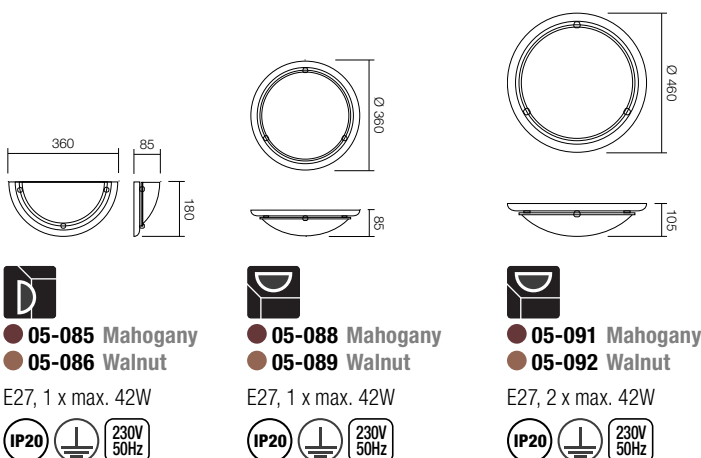





SPOT- LIGHTS

Cameo



Series of lamps for interior, structure and diffuser of die cast aluminium electrostatically painted in mat white or mat black.



04-468

RO - Serie de corpuri pentru interior, structură și dispersor din aluminiu turnat sub presiune vopsite în câmp electrostatic alb mat sau negru mat.

IT - Serie di apparecchi per interni, struttura e paralume in pressofusione di alluminio verniciati a polveri bianco opaco o nero opaco.

RU - Серия светильников для интерьера, структура и рассеиватель из алюминия литого под давлением окрашены в электростатическом поле в белый матовый или черный матовый цвет.

HU - Beltéri lámpatestek, elektrosztatikus mezőben matt fehér vagy matt feketére festett, nyomás alatt öntött alumínium szerkezet és ernyő.

BG - Серия от интериорни осветителни тела, основа и дифузер от лят алуминий, електростатично боядисан в бял мат или черен мат.

SK - Série svietidiel pre interiér, konštrukcia a difúzor z liateho hliníka elektrostaticky lakovaná v matnej bielej alebo matnej čiernej farbe.



04-469



04-474



04-471



04-474

INFO/DIMENSIONS

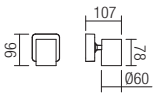

- 04-467 Mat White
- 04-468 Mat Black

GU10, 1 x max. 35W

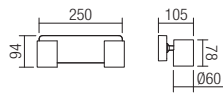

- 04-469 Mat White
- 04-470 Mat Black

GU10, 2 x max. 35W

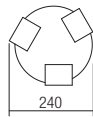
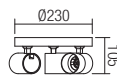

- 04-471 Mat White
- 04-472 Mat Black

GU10, 3 x max. 35W

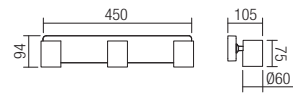

- 04-473 Mat White
- 04-474 Mat Black

GU10, 3 x max. 35W



Vertigo



Indoor spotlights, chromed metal structure, diffuser of mat white painted metal with circular decorative perforations.

RO - Corpuri de iluminat pentru interior, structură din metal cromat, dispersor din metal vopsit alb cu perforații decorative circulare.

IT - Apparecchi di illuminazione per interni, struttura in metallo cromato, diffusore in metallo verniciato bianco opaco con perforazioni decorative circolari.

RU - Светильники для интерьера структура из хромированного металла, рассеиватель из окрашенного в белый цвет матового металла с круглыми декоративными перфорациями.

HU - Beltéri lámpa testek, króm fémszerkezet, fehér fém diszperzór, kör dísz kivágásokkal.

BG - Интериорни насочващи осветителни тела, корпус от хромиран метал, дифузер от метал в цвят бял мат, с кръгли декоративни перфорации.

SK - Interiérové spotové svietidlá, chrómová štruktúra, difúzor v matnej bielej farbe s kruhovými dekoráciami.



04-509

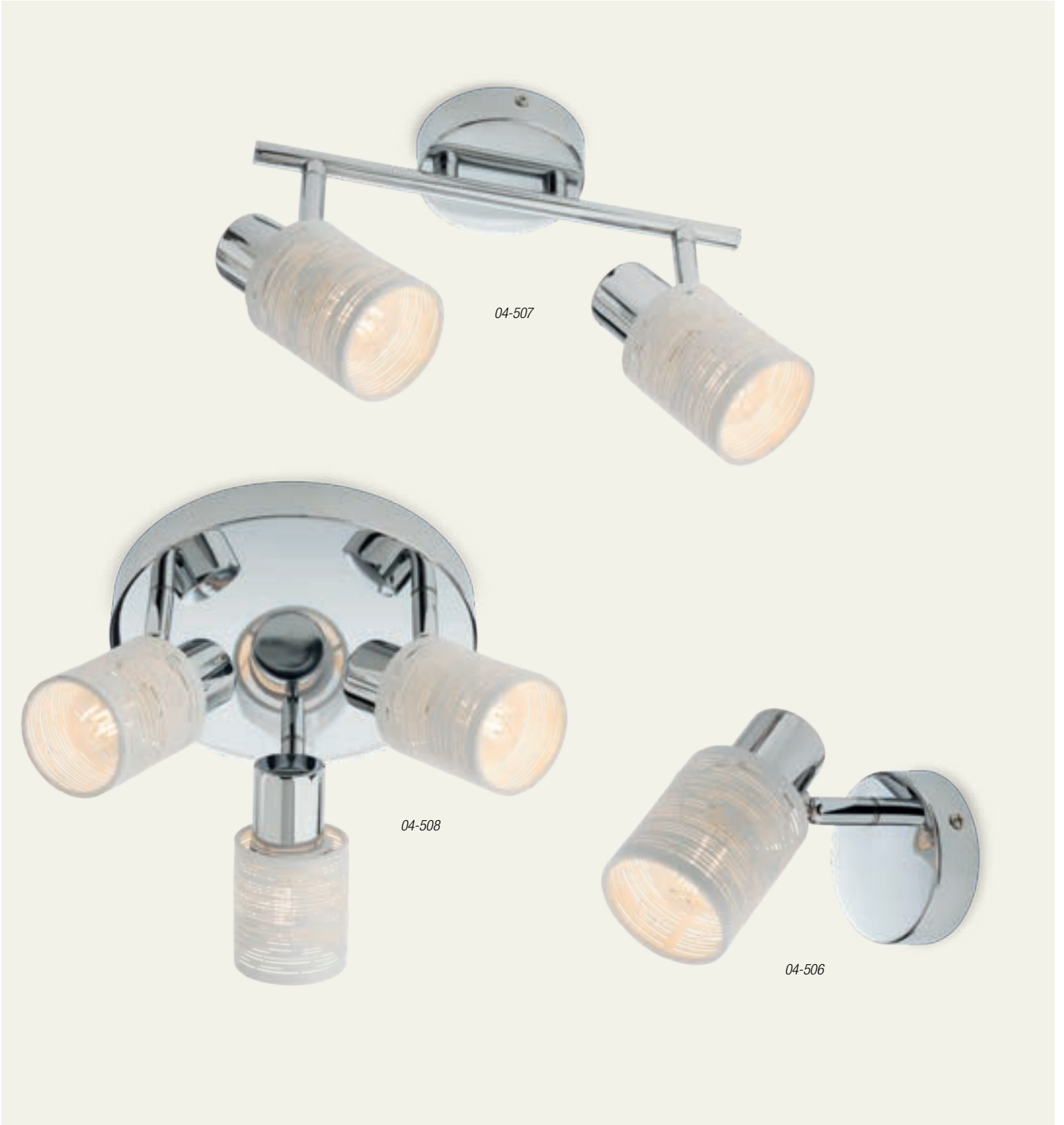

04-507

04-508

04-506

INFO/DIMENSIONS

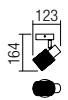

04-506

E14, 1 x max. 28W

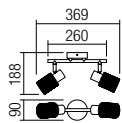

04-507

E14, 2 x max. 28W

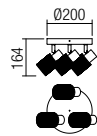

04-508

E14, 3 x max. 28W

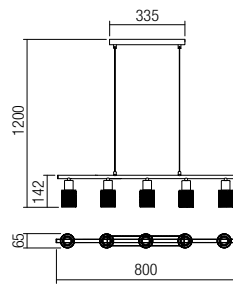

04-509

E14, 5 x max. 28W



Basket



Series of light fixtures for interior, metal structure painted in sand black and natural wood resembling decorations, fretted bronze shades. Bulbs not included.

RO · Serie de corpuri de iluminat pentru interior, structură din metal vopsit negru mat cu decorațiuni finisate tip lemn natur, abajururi din metal traforat bronz. Becurile nu sunt incluse.

IT · Serie di apparecchi per interni, struttura in metallo nero opaco con decorazioni verniciate tipo legno naturale, paralumi in metallo traforato finitura bronzo. Lampadine non incluse.

RU · Серия светильников для интерьера, структура из металла, покрашенного в матовый черный, с отделкой в виде декоративных украшений, похожих на натуральное дерево, с металлическими абажурами, отделанными под лепную бронзу. Лампочки не включены.

HU · Beltéri lámpa testek, matt fekete fém szerkezet natúr fa diszítéssel, bronz színű fém ernyő. Az izzó nem tartozék.

BG · Серия осветителни тела за интериор, метална структура, боядисана в матово черно, декорации със завършек от тип естествено дърво, абажури от бронзов перфориран метал. Крушките не са включени.

SK · Sériá interiérových svietidiel, kovová konštrukcia lakovaná pieskovou čiernou s prírodnými drevenými ozdobami. Žiarovky nie sú súčasťou balenia.



04-519

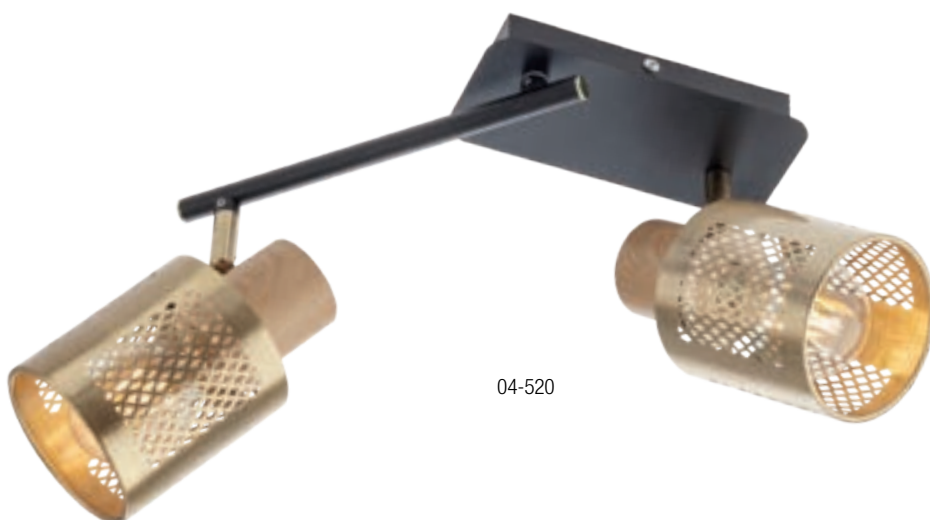

04-520

INFO/DIMENSIONS

**04-519**

E27, 1 x max. 42W

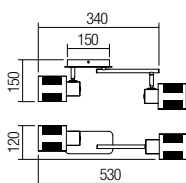
**04-520**

E27, 2 x max. 42W

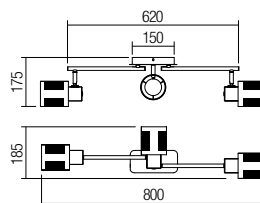
**04-521**

E27, 3 x max. 42W

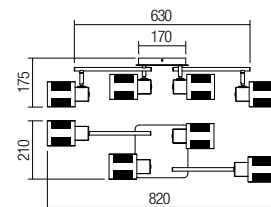
**04-522**

E27, 4 x max. 42W





04-521



04-522

Pons



Light fixtures for interior, metal structure painted in mat black with chromed details, fretted rose gold shades. Bulbs not included.

RO - Corpuri de iluminat pentru interior, structură din metal vopsit negru mat cu detalii cromate, abajururi din metal traforat finisat aur roz. Becurile nu sunt incluse.

IT - Apparecchi luminosi per interni, struttura in metallo nero opaco con dettagli cromati, paralumi in metallo traforato finitura oro rosa. Lampadine non incluse.

RU - Светильники для интерьера, структура из металла, покрашенного в матовый черный с хромированными деталями, с металлическими абажурами, отделанными под лепное золото. Лампочки не включены.

HU - Beltéri lámpa testek, matt fekete fém szerkezet króm diszítéssel, arany színű fém ernyő. Az izzó nem tartozék.

BG - Осветителни тела за интериор, метална структура, боядисана в матово черно, с хромирани детайли, абажури от перфориран метал с розово злато завършек. Крушките не са включени.

SK - Interiérové svietidlá, kovová konštrukcia lakovaná v matnej čiernej farbe s chrómovanými detailami, s odtieňmi ružového zlata. Žiarovky nie sú súčasťou balenia.



04-523

INFO/DIMENSIONS

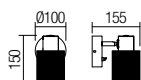

04-523

E27, 1 x max. 42W

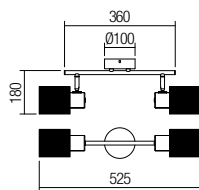

04-524

E27, 2 x max. 42W

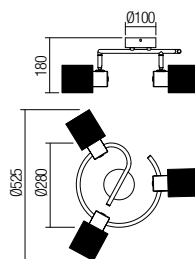

04-525

E27, 3 x max. 42W

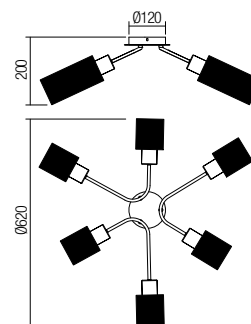

04-526

E27, 6 x max. 42W





04-524



04-525



04-526

Ronin

Series of light fittings for interior, metal structure electrostatically painted in black with fretted copper plated metal diffusers.

RO · Serie de lămpi pentru interior, structură din metal vopsit în câmp electrostatic negru cu dispersoare din metal traforat finisaj cupru.

IT · Serie di lampade per interni, struttura in metallo verniciato a polveri nero, diffusori in metallo traforato finitura rame.

RU · Серия светильников для интерьера, металлическая конструкция окрашенная в электростатическом поле в черный цвет с рассеивателями из тесненного металла с медной отделкой.

HU · Beltéri világítótestek, elektrosztatikus mezőben festett fekete fémszerkezet, réz diszperzór.

BG · Серия интериорни осветителни тела, метална структура електростатично боядисана в черно с прояден метален разсейвател с медно покритие.

SK · Sériá interiérových svietidiel, kovová konštrukcia lakovaná v čiernej farbe, s medenými difúzormi.



INFO/DIMENSIONS

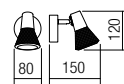

04-456

E14, 1 x max. 28W

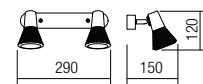

04-457

E14, 2 x max. 28W

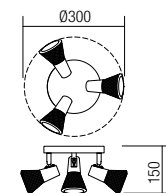

04-458

E14, 3 x max. 28W

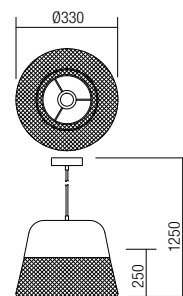

04-459

E27, 1 x max. 42W





04-459



Torn



Light fixtures for interior, metal structure painted in mat black with bronze details, fretted bronze shades. Bulbs not included.



04-516

RO · Corpuri de iluminat pentru interior, structură din metal vopsit negru mat cu detalii bronz, abajururi din metal traforat finisat bronz. Becurile nu sunt incluse.

IT · Apparecchi per interni, struttura in metallo nero opaco con dettagli bronzo, paralumi in metallo traforato finitura bronzo. Lampadine non incluse.

RU · Светильники для интерьера, структура из металла, покрашенного в матовый черный с бронзовыми деталями, с металлическими абажурами, отделанными под лепное золото. Лампочки не включены.

HU · Beltéri lámpa testek, matt fekete fém szerkezet bronz díszítéssel, bronz színű fém ernyő. Az izzó nem tartozék.

BG · Осветителни тела за интериор, метална структура, боядисана в матово черно, с бронзови детайли, абажури от перфориран метал с бронзов завършек. Крушките не са включени.

SK · Interiérové svietidlá, kovová konštrukcia lakovaná v matnej čiernej farbe s bronzovými detailami, s bronzovými odtieňmi. Žiarovky nie sú súčasťou balenia.

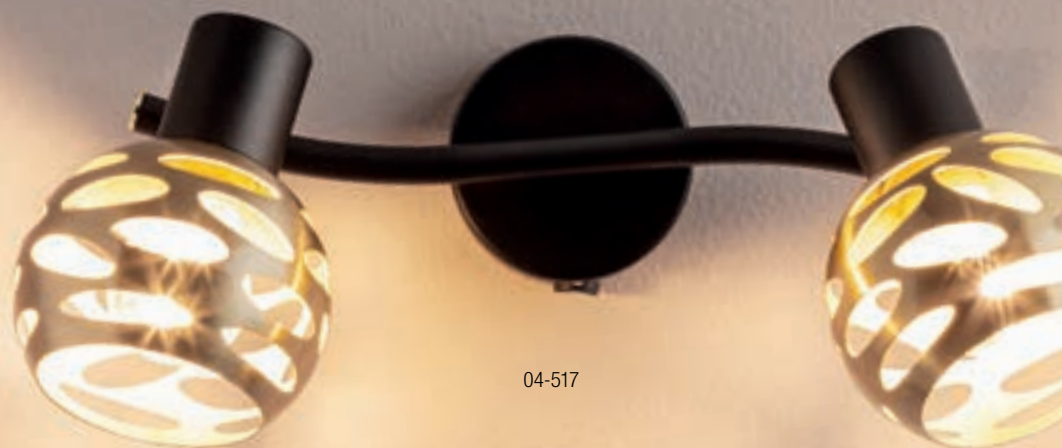

04-517



04-517



04-518

INFO/DIMENSIONS

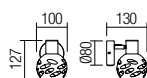
**04-516**

E14, 1 x max. 28W

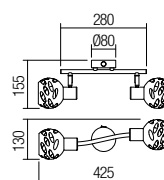
**04-517**

E14, 2 x max. 28W

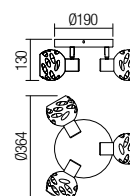
**04-518**

E14, 3 x max. 28W





Series of interior light fittings, metal structure electrostatically painted in mat black with antique copper details.



04-499

RO - Serie de corpuri de iluminat pentru interior, structură metalică vopsită electrostatic în negru mat cu detalii de cupru antichizat.

IT - Serie di lampade per interni, struttura in metallo verniciato elettrostaticamente in nero opaco con dettagli in rame antico.

RU - Серия светильников для внутреннего освещения, металлическая структура, окрашенная в электростатическом поле в матово-черный цвет с элементами античной меди.

HU - Beltéri lámpa testek, elektrosztatikus mezőben matt feketére festett fémszerkezet antik réz betéttel.

BG - Интериорни осветителни тела, корпус от метал, боядисан в черен мат с детайли в цвят античен мед.

SK - Sériá interiérových svietidiel, kovová štruktúra lakovaná v matnej čiernej farbe s detailami v antickej medenej farbe.



04-502

04-499



04-502

04-501

04-500

INFO/DIMENSIONS

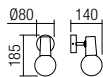

04-499

E27, 1 x max. 42W

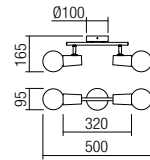

04-500

E27, 2 x max. 42W

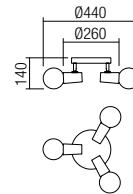

04-501

E27, 3 x max. 42W

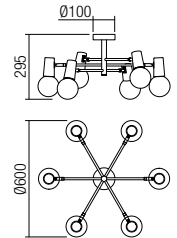

04-502

E27, 6 x max. 42W



Magis



Series of lamps for interior, structure of metal with mat black finishing and chromed detail or chromed metal with mat black details, shades of chromed glass with linear transparent decorations. Bulbs not included.

RO · Serie de lămpi pentru interior, structură din metal negru mat cu ornament cromat sau din metal cromat cu detalii negru mat, abajururi din sticlă cromată cu decor liniar transparent. Becurile nu sunt incluse.

IT · Serie di apparecchi per interni, struttura in metallo finitura nero opaco con ornamento cromato o in metallo cromato con dettagli finitura nero opaco, diffusori in vetro cromato con decoro lineare trasparente. Lampadine non incluse.

RU · Серия светильников для интерьера, металлическая структура в матово-черной отделке с хромированными деталями, абажуры из хромированного стекла с прозрачными линейными украшениями. Лампы не входят в комплект.

HU · Beltéri lámpatestek, matt fekete fémszerkezet króm díszítéssel vagy króm fémszerkezet matt fekete díszítéssel, áttetsző öveg lineárisan króm szíszítéssel. Az izzó nem tartozék.

BG · Серия от интериорни осветителни тела, метална основа с чернен матов завършек и хромни детайли или хромиран метал с черни матови детайли. Абажур от хромно стъкло с линейни прозрачни декорации. Лампите не са включени.

SK · Sérija svietidiel pre interiér, konštrukcia kovu s matnou čiernou úpravou a chrómované detaily alebo pochromovaný kov s matnými čiernymi detailmi, tienidlá chrómového skla s lineárnymi priehľadnými dekoráciami. Žiarovky nie sú súčasťou balenia.



04-482



04-481

04-480

04-479

INFO/DIMENSIONS

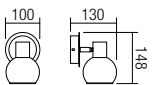

04-479

E14, 1 x max. 28W

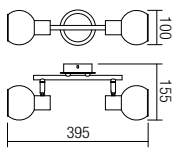

04-480

E14, 2 x max. 28W

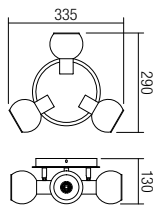

04-481

E14, 3 x max. 28W

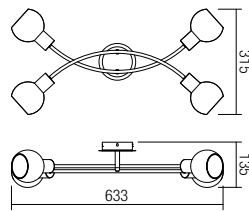

04-482

E14, 4 x max. 28W



Amber



Series of lamps for interior, metal structure with mat black finishing, transparent amber glass shades. Bulbs not included.

RO · Serie de corpuri de iluminat pentru interior, structură din metal finisat negru mat, abajururi din sticlă ambră transparentă. Becurile nu sunt incluse.

IT · Serie di apparecchi per interni, struttura in metallo finitura nero opaco, diffusori in vetro ambrà trasparente. Lampadine non incluse.

RU · Серия светильников для интерьера, структура из металла окрашенного в черный матовый цвет, абажуры из прозрачного янтарного стекла. Лампы не входят в комплект.

HU · Beltéri lámpatestek, matt fekete fémszerkezet, áttetsző borostyán üveg. Az izzó nem tartozék.

BG · Серия от интериорни осветителни тела, метална основа с черен матов завършек, абажур от прозрачно кехлибарено стъкло. Лампите/крушките не са включени.

SK · Sériá svietidiel pre interiér, konštrukcia kovu s matnou čiernou povrchovou úpravou, priehľadné tienidlá z jantárového skla. Žiarovky nie sú súčasťou balenia.



04-485



04-484

INFO/DIMENSIONS

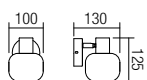
**04-483**

E14, 1 x max. 28W

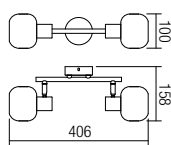
**04-484**

E14, 2 x max. 28W

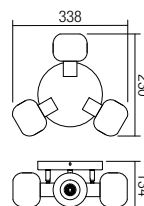
**04-485**

E14, 3 x max. 28W

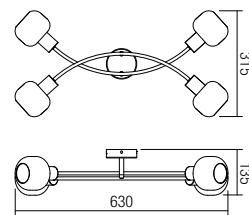
**04-486**

E14, 4 x max. 28W





04-486



04-483



Bowie



Series of light fitting for interior, metal structure with antique gold finishing and natural wood resembling painted decorations, transparent amber glass shades. Bulbs not included.

RO · Serie de corpuri de iluminat pentru interior, structură din metal finisat aur antichizat cu decorațiuni vopsite tip lemn natur, abajururi din sticlă ambra transparentă. Securile nu sunt incluse.

IT · Serie di apparecchi, struttura in metallo finitura oro anticato con decori verniciati tipo legno naturale, paralumi in vetro ambra trasparente. Lampadine non incluse.

RU · Серия светильников для интерьера, структура из металла отделанного под состаренное золото с украшениями под натуральное дерево, абажуры из прозрачного янтарного стекла. Лампы не входят в комплект.

HU · Beltéri lámpatestek, antikolt arany fémszerkezet natúr fa utánzatú díszítéssel, áttetsző borostyán üveg. Az izzó nem tartozék.

BG · Серия от интериорни осветителни тела, метална основа със завършек в състарено злато и натурално дърво, наподобяващо рисувани декорации. Абажур от прозрачно кехлибарено стъкло. Лампите/крушките не са включени.

SK · Sériá svietidiel pre interiér, kovová konštrukcia so starožitným zlatom a prírodným drevom pripomínajúcim maľované dekorácie, priehľadné tienidlá z jantárového skla. Žiarovky nie sú súčasťou balenia.



04-477



04-475

INFO/DIMENSIONS

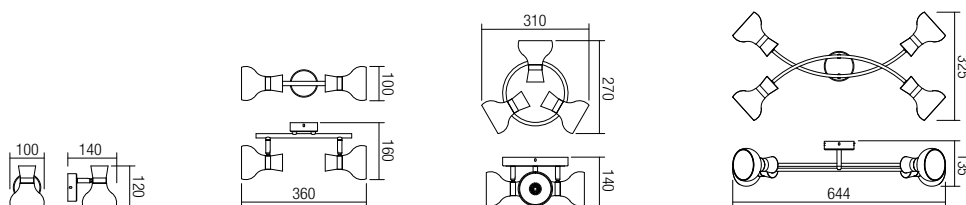
**04-475**

E14, 1 x max. 28W

**04-476**

E14, 2 x max. 28W

**04-477**

E14, 3 x max. 28W

**04-478**

E14, 4 x max. 28W





04-478



04-476

Tom

Series of light fittings for interior, metal structure finished in wenge, white alabaster glass lampshades.

RO · Serie de corpuri de iluminat pentru interior, structură din metal finisat wenge, abajururi din sticlă tip alabastru alb.

IT · Serie di lampade per interni, struttura in metallo finitura wenge, paralumi in vetro alabastro bianco.

RU · Серия светильников для внутреннего освещения, металлическая конструкция с отделочным слоем венге, стеклянные абажуры типа белого алебаstra.

HU · Beltéri világítótest sor, wenge kikészítésű fémszerkezettel, kékesfehér üveg lámpaernyőkkel.

BG · Серия интериорни осветителни тела, структура от метал с покритие венге, абажури от стъкло тип синьо бяло.

SK · Rad svetidiel pre interiér, konštrukcie z kovu Wenge, tienidlo biele alabastrové sklo.

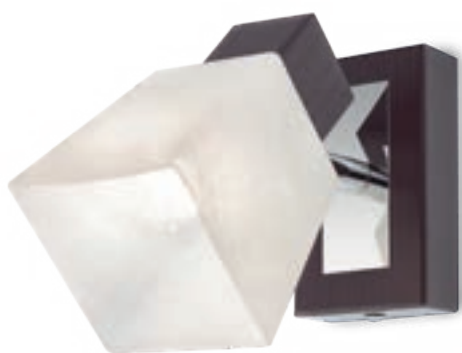

04-436



04-437

INFO/DIMENSIONS

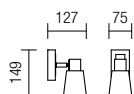
**04-436**

E14, 1 x max. 28W

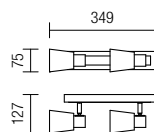
**04-437**

E14, 2 x max. 28W

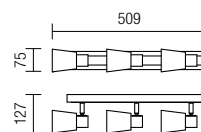
**04-438**

E14, 3 x max. 28W

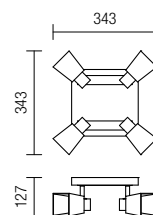
**04-439**

E14, 4 x max. 28W





04-439



04-438

Glam



Series of light fittings for interior, chromed metal structure and diffusers of chromed metal braiding with glass decorations

RO · Serie de corpuri de iluminat pentru interior, structură din metal cromat și dispersoare din împletitură metalică cromată, cu decorațiuni din sticlă.

IT · Serie di apparecchi per interni, struttura in metallo cromato, diffusori in rete metallica cromata con decorazioni in vetro.

RU · Серия светильников для внутреннего освещения, металлическая хромированная структура, диффузоры из металлической хромированной оплетки со стеклянными украшениями.

HU · Beltéri világítótestek sorozata, krómozott fémszerkezet és krómozott fémes fonat diszperzórok, üveg díszítőelemekkel.

BG · Серия интериорни осветителни тела, структура от хромиран метал и разсейватели от хромирана метална плетка, със стъклени украшения.

SK · Rad svetidiel pre interiér, chrómová kovová konštrukcia a pochrómovaný kov so sklenenými ozdobami.



04-373



04-372



04-375



04-374

INFO/DIMENSIONS

<p>04-372 E14, 1 x max. 28W IP20 230V 50Hz</p>	<p>04-373 E14, 2 x max. 28W IP20 230V 50Hz</p>	<p>04-374 E14, 3 x max. 28W IP20 230V 50Hz</p>	<p>04-375 E14, 5 x max. 28W IP20 230V 50Hz</p>



FOR KIDS



Indoor lamps for interior, structure and diffusers of multicolored metal and natural wood decorations.

RO · Serie de lămpi pentru interior, structură și dispersoare din metal vopsit multicolor, ornamente din lemn natur.

IT · Serie di lampade per interni, struttura e paralumi in metallo verniciato multicolore, ornamenti in legno naturale.

RU · Серия ламп для внутреннего освещения, структура и рассеиватели из металла окрашенного в различные цвета, украшения из натурального дерева.

HU · Lámpák sorozat belső számára, többszínű ernyő és fémszerkezet, natúr fa díszekkel.

BG · Серия вътрешни лампи, структура и разсейватели от метал боядисан многоцветно, орнаменти от естествено дърво.

SK · Interiérové lampy, kovová štruktúra a difúzery vo viacfarebnom prevedení s prírodnými drevenými dekoráciami.



04-511



04-510

INFO/DIMENSIONS

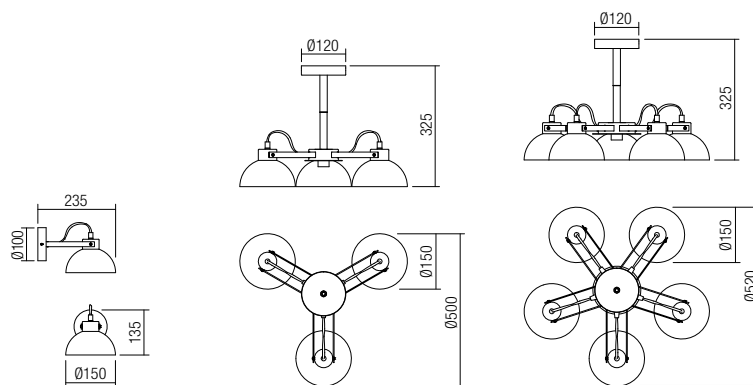

● **04-510** Red
● **04-511** Blue

E27, 1 x max. 42W



04-512

E27, 3 x max. 42W



04-513

E27, 5 x max. 42W





04-512



04-513

Safari



Light fixtures for interior, structure of metal painted in green or in white and green plastic, ornaments of multicolored PVC.

RO · Corpuri pentru interior cu structură din metal vopsit verde sau din plastic alb și verde, decorațiuni din PVC multicolore.

IT · Apparecchi per interni, struttura in metallo verniciato verde o in plastica bianca e verde, ornamenti in PVC multicolore.

RU · Светильники для интерьера, структура из металла окрашено в зеленый или пластика белого и зеленого цвета, украшения из разноцветного ПВХ.

HU · Beltéri lámpatestek, zöld fém szerkezet vagy fehér, zöld műanyag, PVC színes díszekkel.

BG · Осветелни тела за интериор със структура от метал боядисан в цвят зелено или от бяла или зелена пластмаса, многоцветни PVC декорации.

SK · Svetidlá pre interiér, štruktúra kovu lakovaná zelenou alebo bielou a zelenou farbou, ozdoby z rôznofarebného PVC.

INFO/DIMENSIONS

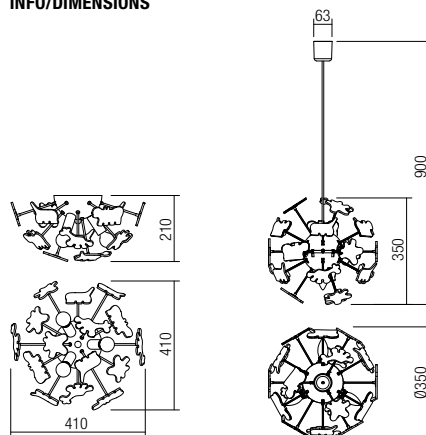

04-514

E14, 3 x max. 28W



04-515

E14, 4 x max. 28W



04-515



04-514



04-514

Happy Plane



Indoor suspensions, painted MDF structure, white blown glass diffusers.

RO · Serie de suspensii pentru interior, structură din MDF vopsit, abajururi din sticlă suflată albă.

IT · Serie di sospensioni per interni, struttura in MDF verniciato, diffusori in vetro soffiato bianco.

RU · Серия подвесок для внутреннего освещения, структура из окрашенного МДФ, абажуры из выдувного стекла белого цвета.

HU · Beltéri felfüggesztések sorozata, festett MDF szerkezet, fehérre fújt üveg lámpaernyő.

BG · Серия интериорни полилеи, структура от боядисан MDF, абажури от бяло духано стъкло.

SK · Interiérové závesné lampy, farbená konštrukcia MDF, difúzor z bieleho fúkaného skla.

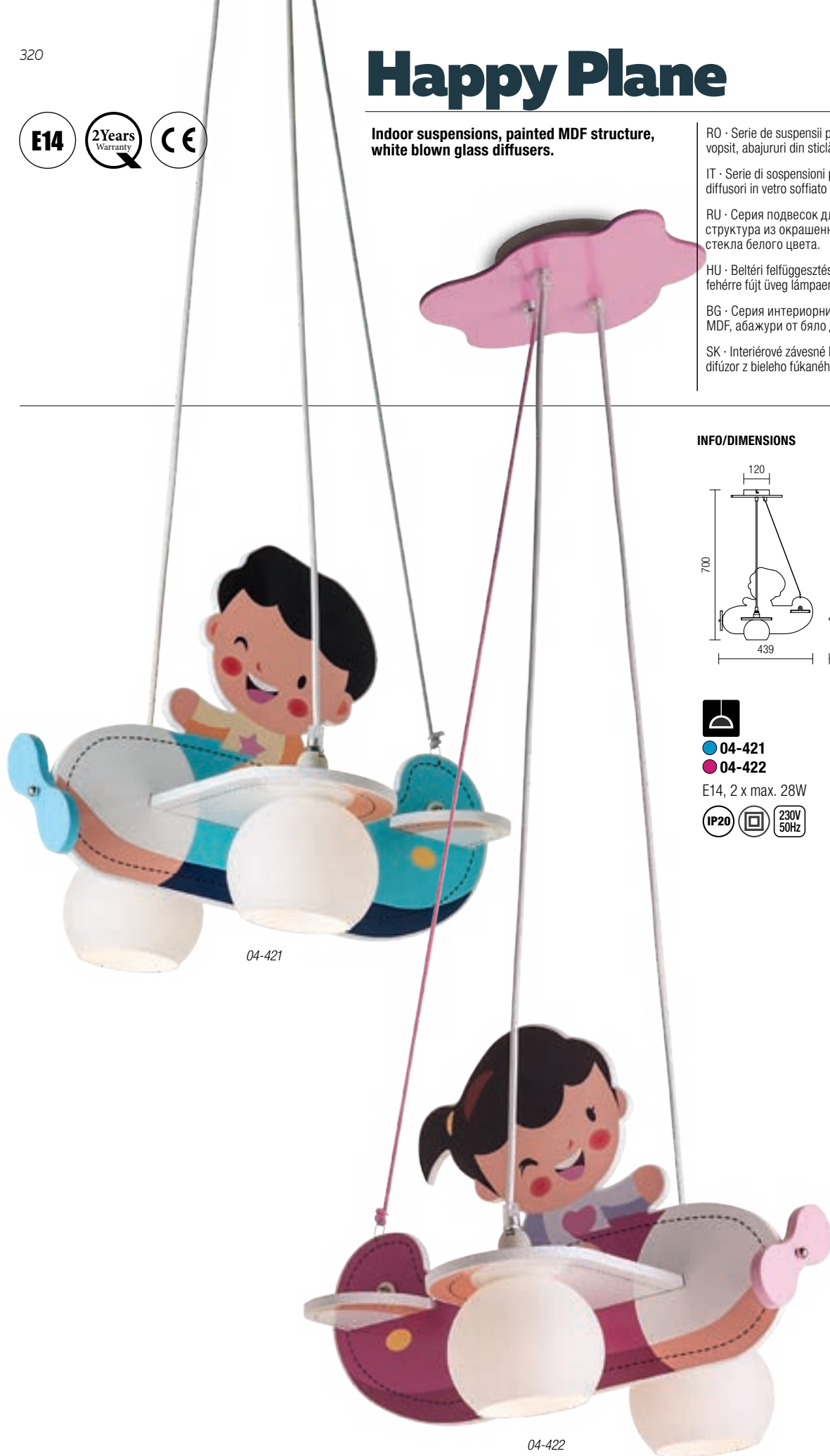

04-421

04-422

INFO/DIMENSIONS

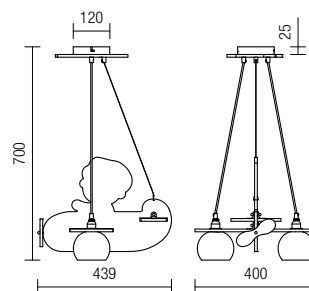

● 04-421

● 04-422

E14, 2 x max. 28W





04-421



Stories

Indoor suspensions, structure and diffuser in multicolor printed plastic material.

RO - Serie de suspensii pentru interior, structură și dispersor din material plastic imprimat multicolor.

IT - Serie di sospensioni per interni, struttura e diffusore in materiale plastico stampato multicolore.

RU - Серия подвесок для внутреннего освещения, структура и диффузор из пластика с многоцветным оттиском.

HU - Beltéri felfüggesztések sorozata, színesre nyomtatott szerkezet és lámpaernyő műanyagból.

BG - Серия интериорни полилеи, структура и разсейвател от пластмаса с многоцветен печат.

SK - Interiérové závesné lampy, štruktúra a difúzor z viacfarebného potlačeného plastového materiálu.

INFO/DIMENSIONS



04-423
04-424
04-425

E27, 1 x max. 28W

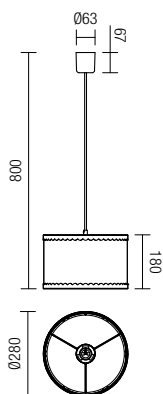

04-425





04-424



04-423

Playlight

Table lamps for interior, equipped with SMD LED RGB+WW, chromed metal base, acrylic diffuser with incisions in shape of smile face, football or terrestrial globe.

RO · Veioze pentru interior, echipate cu LED SMD RGB +WW, bază din metal cromat, dispersor din acril cu incizii decor față zâmbitoare, minge de fotbal sau glob pământesc.

IT · Lampade da tavolo per interni, equipaggiate con LED SMD RGB+WW, base in metallo cromato, diffusore in acrilico con incisioni in forma di faccia sorridente, palla di calcio o globo terrestre.

RU · Настольные лампы для интерьера, оснащенная SMD LED RGB + WW, акриловый диффузор с изображением улыбающиеся лица, футбольные или земные зарисовки.

HU · Beltéri asztali lámpák, króm fémszerkezet, akril diszperzór képekkel nevető arc, futball labda, földgömb.

BG · Настолни интериорни осветителни тела, база от хромиран метал, разсейвател от акрил – усмихнато лице, футбол или скици на земята.

SK · Interiérové stolové lampy vybavená SMD LED RGB + WW, chrómovaná kovová základňa, akrylátový difúzor s incíziou úsmev, futbal, zem.

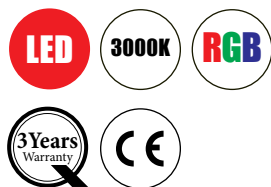

04-503

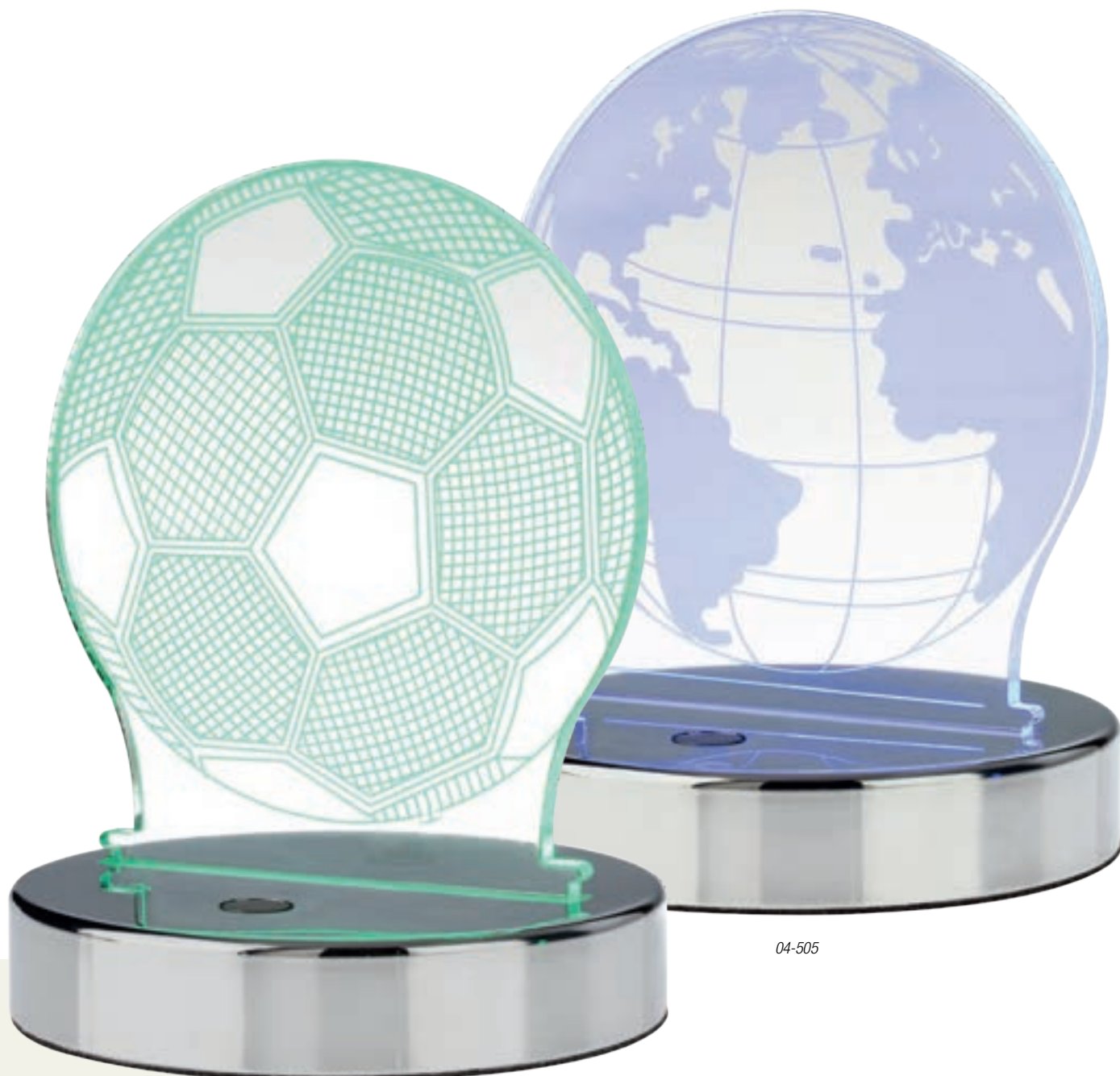

04-504

04-505

INFO/DIMENSIONS

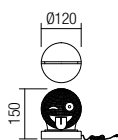

04-503
SMD LED · 3,5W
3000K + RGB · CRI 80
LED flux 309 lm
Luminaire flux 165 lm

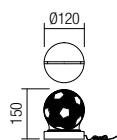

04-504
SMD LED · 3,5W
3000K + RGB · CRI 80
LED flux 309 lm
Luminaire flux 165 lm

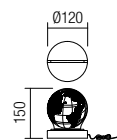

04-505
SMD LED · 3,5W
3000K + RGB · CRI 80
LED flux 309 lm
Luminaire flux 165 lm





BATH ROOM

Neptune



Series of indoor wall lamps protected against humidity, equipped with SMD LEDs, structure available in two versions, aluminium painted in mat white with polycarbonate end caps painted in mat white or chromed aluminium with chromed polycarbonate end caps, diffuser of opal PMMA.

RO · Serie de aplicе pentru interior protejate la umiditate echipate cu LED-uri SMD, structură disponibilă în două versiuni, din aluminiu vopsit alb mat cu elemente terminale din policarbonat vopsite alb mat sau din aluminiu cromat cu elemente terminale din policarbonat cromat, dispersor din PMMA opal.

IT · Serie di applique per interni protette contro l'umidità, equipaggiate con LED SMD, struttura disponibile in due versioni, in alluminio verniciato bianco opaco con elementi terminali in policarbonato verniciati bianco opaco o in alluminio cromato con elementi terminali in policarbonato cromato, diffusore in PMMA opale.

RU · Серия светильников для интерьера оснащенных светодиодами SMD, с защитой от влаги, возможны в двух вариантах, структура из алюминия окрашенного в белый цвет с концевыми элементами из белого поликарбоната или структура из хромированного алюминия с концевыми элементами из хромированного поликарбоната, рассеиватель из опалового PMMA.

HU · Beltéri falikarok, IP védelemmel, SMD LED-el szerelve, kétféle kivitelben: matt fehér alumínium szerkezet matt fehér polkarbonát végződéssel vagy krómzott alumínium szerkezet króm polkarbonát végződéssel, opál PMMA diszperzór.

BG · Серия от интериорни аплици, защитени срещу замърсявания, оборудвани с SMD диоди. Основа в два варианта - алуминий, боядисан в бял мат с поликарбонатни матови капачки, боядисани в бял мат или хромиран алуминий с хроми поликарбонатни крайни капачки. Дифузер от опалов PMMA.

SK · Sériа interiérových nástenných svietidiel chránených pred vlhkosťou, vybavených LED diódami SMD, štruktúra k dispozícii v dvoch verzách, hliníková lakovaná v matnej bielej farbe s polykarbonátovými koncovkami v matnej bielej alebo chrómovanom hliníku s chrómovanými polykarbonátovými koncovými uzávermi, difúzor opálového PMMA.



INFO/DIMENSIONS

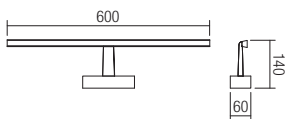

D
 ○ 01-1671 White
 ● 01-1672 Chrome
 SMD LED · 12W · 3000K · CRI 85
 LED flux 1242 lm
 Luminaire flux 798 lm



D
 ○ 01-1673 White
 ● 01-1674 Chrome
 SMD LED · 12W · 4000K · CRI 85
 LED flux 1336 lm
 Luminaire flux 846 lm

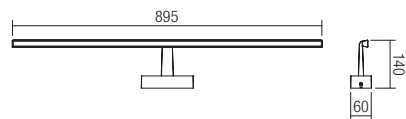

D
 ○ 01-1675 White
 ● 01-1676 Chrome
 SMD LED · 18W · 3000K · CRI 85
 LED flux 1846 lm
 Luminaire flux 982 lm



D
 ○ 01-1677 White
 ● 01-1678 Chrome
 SMD LED · 18W · 4000K · CRI 85
 LED flux 1976 lm
 Luminaire flux 1041 lm





Indoor wall lamps equipped with SMD LEDs, protected against humidity, white painted aluminium structure, opal PMMA diffuser.

RO · Aplice pentru interior echipate cu LED-uri SMD, cu grad de protecție la umiditate, structură din aluminiu vopsită alb și dispersor din PMMA opal.

IT · Applique per interni equipaggiate a LED SMD, con grado di protezione contro l'umidità, struttura in alluminio verniciato bianco, diffusore in PMMA opale.

RU · Бра для интерьера оснащенные светодиодами SMD, с защитой от влаги, структура из алюминия окрашенного в белый цвет и рассеиватель из опалового PMMA.

HU · Beltéri fali lámpák, SMD LED-el szerelve, IP védelemmel ellátva. Fehér alumínium szerkezet, opál PMMA diszperzór.

BG · Интериорни аплици, с SMD светодиоди, защитени от влага, бяло боядисана алуминиева структура, опалов PMMA дифузер.

SK · Interiérové nástenné svietidlá vybavené LED diódami SMD, chránené pred vlhkosťou, hliníková štruktúra s bielym lakovaním, opálový difúzer PMMA.



INFO/DIMENSIONS

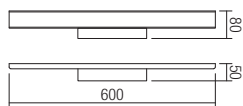

01-1526

SMD LED · 24W · 4000K · CRI 85

LED flux 3100 lm

Luminaire flux 1600 lm

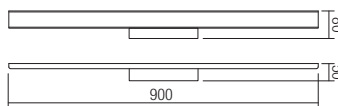

01-1527

SMD LED · 36W · 4000K · CRI 85

LED flux 4650 lm

Luminaire flux 2300 lm





Avance

Indoor wall lamps equipped with SMD LEDs, chromed metal structure, opal glass diffuser.



RO · Aplice pentru interior echipate cu LED-uri SMD, structură din metal cromat cu dispersor din sticlă alb opal.

IT · Applique per interni equipaggiate con LED SMD, struttura in metallo cromato, diffusore in vetro opalino bianco.

RU · Бра для интерьера, оснащенное светодиодами SMD, структура из хромированного металла, рассеиватель из белого опалового стекла.

HU · Beltéri falikar, SMD LED-el szerelve, króm fémszerkezet, opál üveg diszperzór.

BG · вътрешни лампи за стена, оборудвани с SMD LED-ове, хромирана метална структура, опален стъклен разсейвател.

SK · Interiérové nástenné svietidlá, vybavené LED SMD diódami, chrómovou konštrukciou a opálovým difúzorom.



01-1429



01-1430



01-1431

INFO/DIMENSIONS

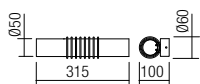

01-1429

SMD LED · 7W · 4000K · CRI 85
LED flux 850 lm
Luminaire flux 482 lm

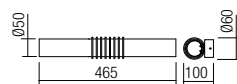

01-1430

SMD LED · 11W · 4000K · CRI 85
LED flux 1450 lm
Luminaire flux 715 lm

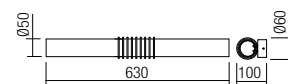

01-1431

SMD LED · 14W · 4000K · CRI 85
LED flux 1850 lm
Luminaire flux 945 lm



01-1430



Series of interior wall lamps protected against humidity, equipped with SMD LEDs, chromed metal housing and frosted acrylic diffuser.

RO · Serie de aplicе pentru interior protejate la umiditate, echipate cu LED-uri SMD, structură din metal cromat cu dispersor din acril satinat.

IT · Serie di applique per interni protette contro l'umidità, equipaggiate con LED SMD, struttura in metallo cromato e diffusore in acrilico satinato.

RU · Серия бра для внутреннего освещения с защитой от влаги, оснащенных светодиодами SMD, металлическая хромированная структура, диффузор из сатинированного акрила.

HU · Nedvességtől védett beltéri falilámpa sorozat, SMD LED-ekkel ellátva, krómozott fémszerkezettel, szatén akril diszperzórrel.

BG · Серия интериорни аплици, защитени срещу влага, оборудвани с SMD LED-ове, структура от хромиран метал с разсейвател от сатениран акрил.

SK · Rad interiérových nástenných lúč, nepremokavé, vybavené SMD LED, v chromovanom kovovom puzdre s mliečnym akrylovým difúzorom.

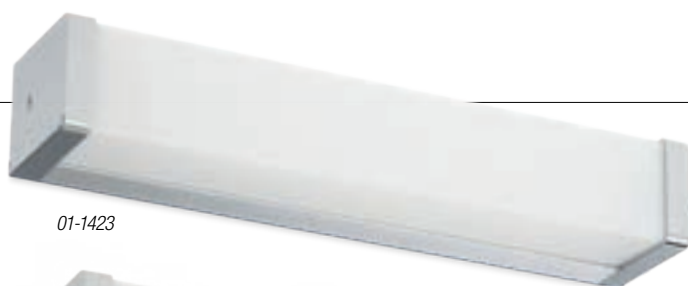

01-1423



01-1424



01-1423

01-1424

INFO/DIMENSIONS

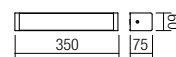

01-1423

SMD LED · 8W · 4000K · CRI 85

LED flux 950 lm

Luminaire flux 650 lm

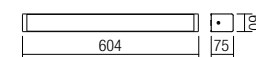

01-1424

SMD LED · 16W · 4000K · CRI 85

LED flux 1900 lm

Luminaire flux 1300 lm



Marker



Indoor wall lamp protected against humidity, equipped with SMD LEDs, structure of aluminum with chromed polycarbonate end caps, diffuser of opal polycarbonate.

RO · Aplică pentru interior protejată la umiditate, echipată cu LED-uri SMD, structură din aluminiu cu elemente terminale din policarbonat cromat și dispersor din policarbonat opal.

IT · Applique per interni protetta contro l'umidità, equipaggiata con LED SMD, struttura in alluminio ossidato con elementi terminali in policarbonato cromato, diffusore in policarbonato opale.

RU · Бра для интерьера с защитой от влаги, оснащенное светодиодами SMD, структура из алюминия, с концевыми элементами из хромированного поликарбоната и рассеивателем из опалового поликарбоната.

HU · IP védett beltéri falikar, SMD LED-el szerelve, alumínium szerkezet polikarbonát króm végekkel, opál polikarbonát diszperzór.

BG · Влагозащитени аплици, оборудвани с SMD LED-ове, арматура от алуминий с хромирани поликарбонатни крайни капачки, разсейвател от опален поликарбонат.

SK · Interiérové nástenné svietidlo, chránené proti vlhkosti, vybavené LED SMD diódami, hliníková konštrukcia s chrómovými polykarbonátovými koncovkami, difúzor z polykarbonátu.



01-1392



INFO/DIMENSIONS

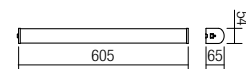

01-1392

SMD LED · 10W · 4000K · CRI 85

LED flux 1150 lm

Luminaire flux 900 lm



Amon



Indoor ceiling lamps protected against humidity, equipped with SMD LEDs, white painted metal structure, opal PMMA diffuser with chrome PMMA exterior frame.

RO · Plafoniere pentru interior protejate la umiditate, echipate cu LED-uri SMD, structură din metal vopsit alb, dispersor PMMA opal cu ramă exterioară din PMMA cromat.

IT · Plafoniere per interni protette contro l'umidità, equipaggiate con LED SMD, struttura in metallo verniciato bianco, diffusore in PMMA opalino con cornice in PMMA cromato.

RU · Потолочные светильники для интерьера, с защитой от влаги, оснащены светодиодами SMD, структура из металла окрашена в белый цвет, опаловый рассеиватель из PMMA с хромированной внешней рамой из PMMA.

HU · Beltéri mennyezeti lámpák, SMD LED-el szerelve, fehér fém szerkezet, opál PMMA diszperzór, króm PMMA külső kerettel.

BG · Таванни осветления за интериор, защитени срещу влага, разполагат със SMD светодиоди, метална структура боядисана в бяло, опалов PMMA дифузер с вътрешна рамка от хромиран PMMA.

SK · Interiérové stropné lampy chránené pred vlhkosťou, vybavené SMD LED diódami, kovovou štruktúrou s bielym lakováním, opálovým difúzorom PMMA s chrómovaným vonkajším rámom PMMA.



01-2180



01-2181

INFO/DIMENSIONS

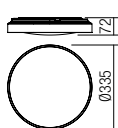

01-2180
SMD LED · 18W
4000K · CRI 80
LED flux 1800 lm
Luminaire flux 930 lm

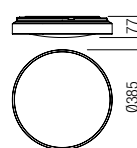

01-2181
SMD LED · 23W
4000K · CRI 80
LED flux 2350 lm
Luminaire flux 1140 lm



01-2181



Zing

Series of indoor waterproof ceiling lamps, equipped with SMD LEDs, structure of chromed acryl and diffuser of transparent acryl decorated with crystal resembling granules.

RO · Serie de plafoniere pentru interior protejate la umiditate, echipate cu LED-uri SMD, structură din acril cromat și dispersor transparent din acril decorat cu granule efect cristal.

IT · Serie di plafoniere per interni protette contro l'umidità, equipaggiate con LED SMD, struttura in acrilico cromato e diffusore in acrilico trasparente con effetto graniglia di cristallo.

RU · Серия потолочных светильников для интерьера с защитой от влаги, оснащенных светодиодами SMD, структура из хромированного акрила и рассеиватель из прозрачного акрила, украшенный гранулами с кристаллическим эффектом.

HU · IP védett beltéri mennyezeti lámpatestek, SMD LED-el szerelve, króm akril lámpatest, kristály hatású áttetsző akril diszperzór.

BG · Серия интериорни влагозащитени плафониери, оборудвани със SMD LED-ове, структура от хромиран акрил и прозрачен разсейвател от акрил, украсен с кристално наподобяващи гранули.

SK · Sériá stropných, vodotesných svietidiel, vybavených LED SMD diódami, štruktúra z chrómového akrylu, difúzor z priehľadného akrylu zdobeného kryštálom.



01-1286

INFO/DIMENSIONS

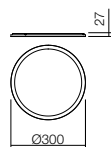

01-1285

SMD LED · 18W · 4000K · CRI 85

LED flux 2282 lm

Luminaire flux 1350 lm

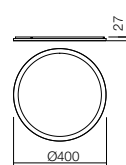

01-1286

SMD LED · 24W · 4000K · CRI 85

LED flux 2863 lm

Luminaire flux 1800 lm





Riba



Series of ceiling lamps protected against humidity, opal white glass diffuser with chromed metal decorative ring and metal frame painted in white.

RO · Serie de plafoniere cu grad de protecție la umiditate, dispersor din sticlă alb opal cu aplicație de metal cromat și montură din metal vopsit alb.

IT · Serie di plafoniere con grado di protezione contro l'umidità, diffusore in vetro bianco opale con applicazione di metallo cromato e montatura di metallo verniciato bianco.

RU · Серия потолочных светильников для интерьера с защитой от влаги, белый опаловый рассеиватель со вставками из хромированного металла и металлический элемент крепления белого цвета.

HU · IP védett beltéri mennyezeti lámpa, fehér színű fémszerkezet, fehér opál üveg króm diszítéssel.

BG · Серия интериорни влагозащитени плафониери, разсейвател от бяло опално стъкло с хромиран метален декоративен ринг и бяла метална рамка.

SK · Sériá stropných svetidiel s IP ochranou pred vlhkosťou, opálový biely sklenený difúzor, kovová štruktúra v bielej farbe.



01-1240



01-1239

INFO/DIMENSIONS

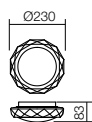
**01-1239**

E27, 1 x max. 42W

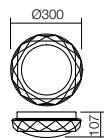
**01-1240**

E27, 2 x max. 42W



01-1240

Orbital

Interior ceiling lamps protected against humidity, white metal structure and opal white blown glass diffuser, decorative black silicone rings.

RO · Plafoniere pentru interior cu grad de protecție la umiditate, structură din metal vopsit alb și dispersor din sticlă suflată alb opal cu inele decorative din silicon negru.

IT · Plafoniere con grado di protezione contro l'umidità, struttura in metallo verniciato bianco, diffusore in vetro soffiato bianco opale con anelli decorativi in silicone nero.

RU · Потолочные светильники для внутреннего освещения со степенью защиты от влаги, металлическая структура, окрашенная в белом цвете, диффузор из выдувного стекла белого опалового цвета с декоративными кольцами из чёрного силикона.

HU · Beltéri mennyezeti lámpák, nedvesség elleni védelemmel, fehérre festett fémszerkezet és opálos fehérre fújt üveg diszperzór fekete szilikon díszítő gyűrűkkel.

BG · Интериорни плафониери със защитна степен срещу влага, структура от метал боядисан в бяло и дисперсор от духано стъкло в бял опал с декоративни пръстени от черен силикон.

SK · Interiérové stojacie lampy s krytím proti vlhkosti, biely kov a opálové biele tienidlo z fúkaného skla, dekoračné čierne silikónové krúžky.



01-697



01-698

INFO/DIMENSIONS

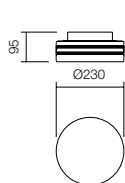

01-697

E27, 1 x max. 42W

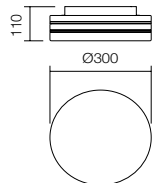

01-698

E27, 2 x max. 42W



Without decorative black silicone rings.



Lunar



Interior ceiling lamps protected against humidity, white metal structure and opal white blown glass diffuser with chromed metal decoration.

RO · Serie de plafoniere cu grad de protecție la umiditate, dispersor din sticlă alb opal cu aplicație de metal cromat și structură din metal vopsit alb.

IT · Serie di plafoniere con grado di protezione contro l'umidità, diffusore in vetro bianco opale con applicazione di metallo cromato, montatura di metallo verniciato in bianco.

RU · Серия потолочных светильников со степенью защиты от влаги, диффузор из стекла белого опалового цвета с украшением из хромированного металла, металлическая структура, окрашенная в белом цвете.

HU · Nedvesség elleni védelemmel rendelkező mennyezeti lámpák sorozata, opálos fehér üveg diszperzór krómozott fém rátéttel és fehérre festett fémszerkezettel.

BG · Серия плафониери със защитна степен срещу влага, дисперсор от бяло стъкло опал с апликация от хромиран метал и структура от метал боядисан в бяло.

SK · Interiérové stropné lampy s vysokým stupňom ochrany proti vlhkosti, biely kov a opálové biele tienidlo z fúkaného skla s chrómovým kovovým dekorom.



01-695



01-694

INFO/DIMENSIONS

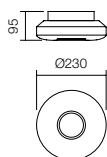
**01-694**

E27, 1 x max. 42W

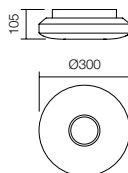
**01-695**

E27, 2 x max. 42W



01-695





Series of ceiling lamps protected against humidity, opal white glass diffuser, metal frame painted in white.

RO · Serie de plafoniere cu grad de protecție la umiditate, cu dispersor din sticlă alb opal și bază din metal vopsit alb.

IT · Serie di plafoniere con grado di protezione contro l'umidità, con diffusore in vetro bianco opale, montatura di metallo verniciato in bianco.

RU · Серия потолочных светильников с защитой против влажности, с диффузором белого стекла опала, металлическая структура, окрашенная в белый цвет.

HU · Nedvesség ellen védelmi fokozatú lámpák sorozat, opál fehér üveg diszperzór, fehérre festett fém szerelés.

BG · Серия плафониери със степен на защита от влага, с разпръсквач от опално и прозрачно стъкло, бяла боядисана метална рамка.

SK · Sériá stropných svietidiel so stupňom krytia proti vlhkosti, opálového bieleho skla, kovovým rámom v bielej farbe.



01-398

INFO/DIMENSIONS

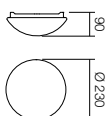

01-239

E27, 1 x max. 42W

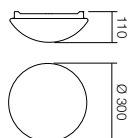

01-398

E27, 1 x max. 52W



Moon



Series of ceiling lamps protected against humidity, opal white glass diffuser with chromed metal application and metal frame painted in white.

RO · Serie de plafoniere cu grad de protecție la umiditate, cu dispersor din sticlă alb opal cu aplicație de metal cromat și montură din metal vopsit alb.

IT · Serie di plafoniere con grado di protezione contro l'umidità, diffusore in vetro bianco opale con applicazione di metallo cromato e montatura di metallo verniciato bianco.

RU · Серия потолочных светильников с уровнем защиты против влажности, с диффузором из стекла белого цвета опала, с декором из хромированного металла и металлической структурой, окрашенной в белый цвет.

HU · Krómozott fém csatlakozású és fehérre festett fém szerelésű opál fehér üvegű diszperzoros nedvesség ellen védelmi fokozatú menyezeti sorozat.

BG · Серия плафониери със степен на защита от влага, с разпръсквач от сатенено стъкло с прилагане от хромен метал и бяла боядисана метална рамка.

SK · Rad stropných svietidiel so stupňom ochrany proti vlhkosti, difúzor z opáľového bieleho skla s aplikáciou chrómu a kovovým rámom v bielej farbe.



01-543

INFO/DIMENSIONS

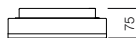
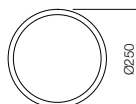
**01-544**

E27, 1 x max. 52W

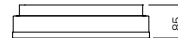
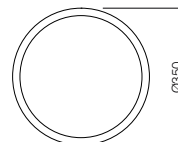
**01-543**

E27, 2 x max. 52W





RECESSED DOWN LIGHTS

PT 05 **LED** **3000K** **3 Years Warranty** **CE**



art. **70399** WH White

COB LED · 3,5+1,5W · 3000K · CRI 80
LED flux 530 lm
Luminaire flux 400 lm

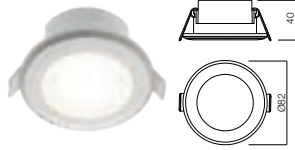

art. **70400** WH White

COB LED · 8,5+3,5W · 3000K · CRI 80
LED flux 1350 lm
Luminaire flux 1100 lm

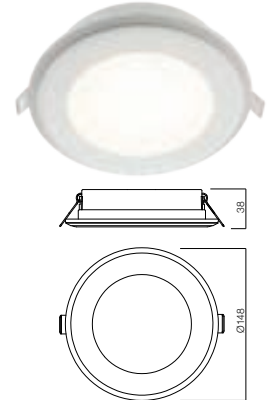

Recessed downlights equipped with SMD LED, mat white polycarbonate structure, frost polycarbonate diffuser, driver included.

RO · Spoturi echipate cu LED-uri SMD, pentru montaj încastrat, structură din policarbonat alb mat, dispersor din policarbonat satinat, alimentator inclus.

IT · Incassi fissi equipaggiati con LED SMD, struttura in policarbonato bianco opaco, diffusore in policarbonato satinato, driver incluso.

RU · Встраиваемые потолочные споты, оснащенные светодиодами SMD, матовая белая структура из поликарбоната, рассеиватель из сатинового поликарбоната, питатель входит в комплект.

HU · Beltéri besülyezett spot lámpa, SMD LED-el, matt fehér műanyag szerkezet, satén polikarbonát diszperzór, működtetőt tartalmaz.

BG · Спотове със SMD светодиоди, за вграден монтаж, структура от матов бял поликарбонат, дифузер от сатен поликарбонат, захранващото устройство е включено.

SK · Zápusťné svietidlá vybavené LED SMD, matná biela polykarbonátová štruktúra, mrazuvzdorný polykarbonátový difúzor, vrátane vodiča.

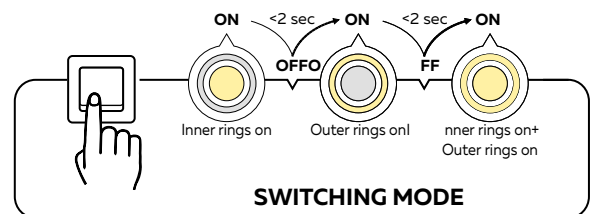



art. **70401** WH White

SMD LED · 3,5+1,5W · 3000K + RGB · CRI 80
LED flux 400 lm
Luminaire flux 360 lm

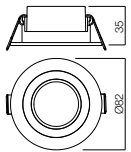

art. **70402** WH White

SMD LED · 8,5+2W · 3000K + RGB · CRI 80
LED flux 1000 lm
Luminaire flux 900 lm

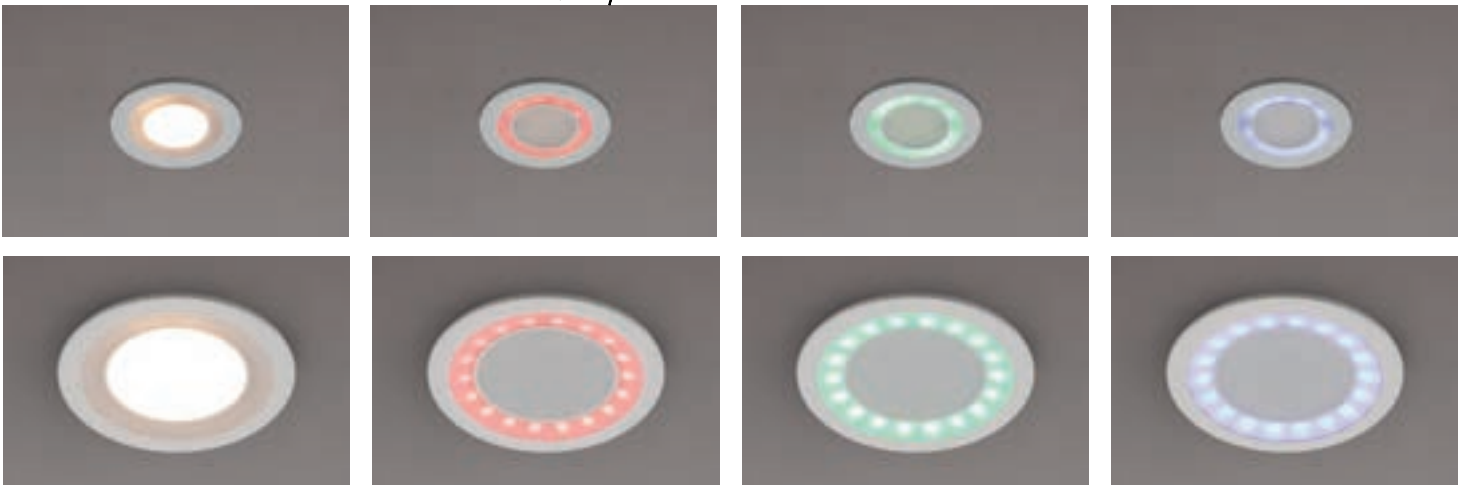
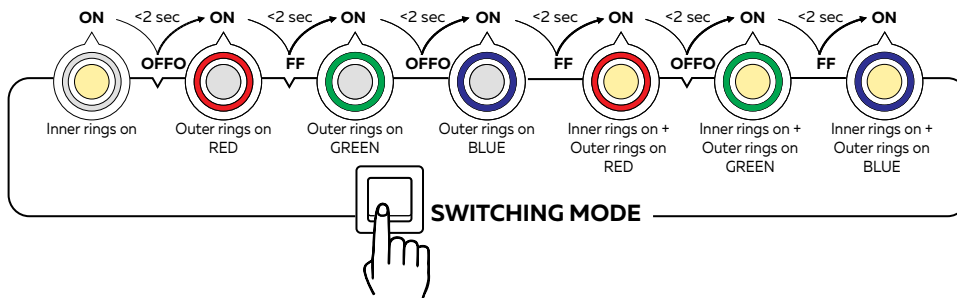
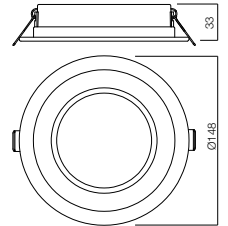

Recessed downlights equipped with SMD LED, mat white polycarbonate structure, frost polycarbonate diffuser, driver included.

RO · Spoturi echipate cu LED-uri SMD, pentru montaj încadrat, structură din policarbonat alb mat, dispersor din policarbonat satinat, alimentator inclus.

IT · Incassi fissi equipaggiati con LED SMD, struttura in policarbonato bianco opaco, diffusore in policarbonato satinato, driver incluso.

RU · Встраиваемые потолочные споты, оснащенные светодиодами SMD, матовая белая структура из поликарбоната, рассеиватель из сатинового поликарбоната, питатель входит в комплект.

HU · Beltéri besülyeszett spot lámpa, SMD LED-el, matt fehér műanyag szerkezet, satén polikarbonát diszperzór, működtetőt tartalmaz.

BG · Спотове със SMD светодиоди, за вграден монтаж, структура от матов бял поликарбонат, дифузер от сатен поликарбонат, захранващото устройство е включено.

SK · Zápustné svietidlá vybavené LED SMD, matná biela polykarbonátová štruktúra, mrazuvzdorný polykarbonátový difúzor, vrátane vodiča.

MT 143 LED



MWH Mat White



MBK Mat Black

- art. **70385** MWH Mat White 3000K
 art. **70378** MWH Mat White 4000K
 art. **70386** MBK Mat Black 3000K
 art. **70379** MBK Mat Black 4000K

COB LED · 10W · 3000K or 4000K · CRI 80
 LED flux 1126 lm or 1164 lm
 Luminaire flux 905 lm or 940 lm
 Optic 36°

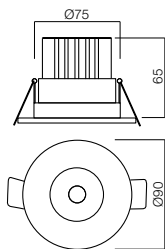

Recessed downlights equipped with COB LED, aluminium structure electrostatically painted in sand white or sand black, aluminium reflector with mirror finish and polycarbonate diffuser. Equipped with driver.

RO · Spoturi de încastrat fixe echipate cu LED COB, structură din aluminiu vopsită în câmp electrostatic alb mat sau negru mat, reflector din aluminiu oglindat și dispersor din policarbonat. Complet echipate cu alimentator.

IT · Incassi fissi equipaggiati con LED COB, struttura in alluminio verniciato a polveri bianco opaco o nero opaco, riflettore in alluminio specchiato e diffusore in policarbonato. Dotati di driver.

RU · Встраиваемые потолочные светильники, оснащенные светодиодами COB, алюминиевый корпус окрашен в электростатическом поле в матовый белый или матовый черный цвет, алюминиевый отражатель с зеркальной отделкой и рассеиватель из поликарбоната. Оборудованы блоками питания.

HU · COB LED-ekkel felszerelt, fix, befogott beszerelésű hidegtükrös lámpa, elektrosztatikus mezőben matt fehérre vagy matt feketére festett alumínium struktúra, tükröző alumínium fényvisszaverővel és polikarbonát fényszóróval. Teljesen felszerelve, tápegységgel.

BG · Фиксирани вградени точкови осветителни тела оборудвани със COB светодиод, алуминиева структура боядисана в электростатично поле в цвят матово бяло или матово черно, рефлектор от отражателен алуминий и поликарбонатен дифузьор. Напълно оборудвани с захранващо устройство.

SK · Zapustené svietidlá vybavené COB LED, hliniková štruktúra lakovaná v matnej bielej alebo matnej čiernej, hlinikový reflektor so zrkadlom a polykarbonátový difúzor. Obsahuje driver.

MT 145 LED



MWH Mat White



MBK Mat Black

- art. **70390** MWH Mat White 3000K
 art. **70383** MWH Mat White 4000K
 art. **70391** MBK Mat Black 3000K
 art. **70384** MBK Mat Black 4000K

COB LED · 11W · 3000K or 4000K · CRI 80
 LED flux 1131 lm or 1168 lm
 Luminaire flux 911 lm or 942 lm
 Optic 36°

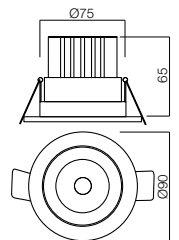

Recessed orientable downlights equipped with COB LED, aluminium structure electrostatically painted in sand white or sand black, aluminium reflector with mirror finish and polycarbonate diffuser. Equipped with driver.

RO · Spoturi de încastrat orientabile echipate cu LED COB, structură din aluminiu vopsită în câmp electrostatic alb mat sau negru mat, reflector din aluminiu oglindat și dispersor din policarbonat. Complet echipate cu alimentator.

IT · Incassi orientabili equipaggiati con LED COB, struttura in alluminio verniciato a polveri bianco opaco o nero opaco, riflettore in alluminio specchiato e diffusore in policarbonato. Dotati di driver.

RU · Встраиваемые ориентируемые потолочные светильники, оснащенные светодиодами COB, алюминиевый корпус окрашен в электростатическом поле в матовый белый или матовый черный цвет, алюминиевый отражатель с зеркальной отделкой и рассеиватель из поликарбоната. Оборудованы блоками питания.

HU · COB LED-ekkel felszerelt, irányítható, befogott beszerelésű hidegtükrös lámpa, elektrosztatikus mezőben matt fehérre vagy matt feketére festett alumínium struktúra, tükröző alumínium fényvisszaverővel és polikarbonát fényszóróval. Teljesen felszerelve, tápegységgel.

BG · Регулируеми вградени точкови осветителни тела оборудвани със COB светодиод, алуминиева структура боядисана в электростатично поле в цвят матово бяло или матово черно, рефлектор от отражателен алуминий и поликарбонатен дифузьор. Напълно оборудвани с захранващо устройство.

SK · Nastavitelné zapustené svietidlá vybavené COB LED, hliniková štruktúra v matnej bielej, alebo matnej čiernej farbe, hlinikový reflektor so zrkadlom a polykarbonátový difúzor. Obsahuje driver.

MT 144 LED



MWH Mat White



MBK Mat Black



MGD Mat Gold

- art. **70387** MWH Mat White 3000K
 art. **70380** MWH Mat White 4000K
 art. **70389** MBK Mat Black 3000K
 art. **70382** MBK Mat Black 4000K
 art. **70388** MGD Mat Gold 3000K
 art. **70381** MGD Mat Gold 4000K

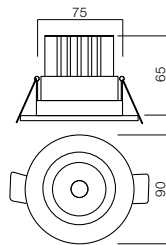

COB LED · 10W · 3000K or 4000K · CRI 80
 LED flux 1124 lm or 1134 lm
 Luminaire flux 903 lm or 926 lm
 Optic 36°



Ø75 mm

Recessed downlights equipped with COB LED, aluminium structure electrostatically painted in sand white, mat gold or sand black, aluminium reflector with mirror finish and polycarbonate diffuser. Equipped with driver.

RO · Spoturi de încastrat fixe echipate cu LED COB, structură din aluminiu vopsită în câmp electrostatic alb mat, auri mat sau negru mat, reflector din aluminiu oglindat și dispersor din policarbonat. Complet echipate cu alimentator.

IT · Incassi fissi equipaggiati con LED COB, struttura in alluminio verniciato a polveri bianco opaco, oro opaco o nero opaco, riflettore in alluminio specchiato e diffusore in policarbonato. Dotati di driver.

RU · Встраиваемые потолочные светильники, оснащенные светодиодами COB, алюминиевый корпус окрашен в электростатическом поле в матовый белый, матовый золотой или матовый черный цвета, алюминиевый отражатель с зеркальной отделкой и рассеиватель из поликарбоната. Оборудованы блоками питания.

HU · COB LED-ekkel felszerelt, fix, befogott beszerelésű hidegtükros lámpa, elektrosztatikus mezőben matt fehérre, matt aranyszínre vagy matt feketére festett alumínium struktúra, tükröző alumínium fényvisszaverővel és polikarbonát fényszóróval. Teljesen felszerelve, tápegységgel.

BG · Фиксирани вградени точкови осветителни тела оборудвани със COB светодиоди, алуминиева структура боядисана в электростатично поле в цвят матово бяло, матово златно или матово черно, рефлектор от отражателен алуминий и поликарбонатен дифузор. Напълно оборудвани с захранващо устройство.

SK · Zapustené svietidlá vybavené COB LED, hliníková štruktúra lakovaná v matnej bielej, matnej zlatej alebo matnej čiernej farbe, hliníkový reflektor so zrkadlom a polykarbonátový difúzor. Obsahuje driver.

MT 128 LED



art. **70363** WH White



art. **70364** AL Aluminium

COB LED · 5W · 4000K · CRI 80
LED flux 508 lm
Luminaire flux 368 lm
Optic 45°



Ø75 mm

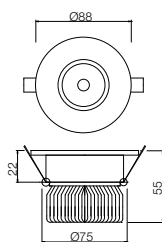

Orientable recessed COB LED downlight, structure and reflector of aluminium, polycarbonate diffuser. Driver included.

RO - Spot de încastrat orientabil cu LED COB, structură din aluminiu, reflector din aluminiu și dispersor din policarbonat transparent. Complet echipat cu alimentator.

IT - Incasso orientabile a LED, struttura in alluminio, riflettore in alluminio e diffusore in policarbonato. Dotato di driver.

RU - Управляемое встраиваемое световое пятно со светодиодами LED COB, алюминиевая конструкция, окрашенная в электростатическом поле, белого цвета, алюминиевый отражатель и диффузор из поликарбоната. Полностью оснащено фидером.

HU - Beépíthető és billenthető COB LED lámpa, elektrosztatikus térben fehérre festett alumínium szerkezettel, alumínium fényszórával és áttetsző polikarbonát diszperzórral. Táppal ellátott szerkezet.

BG - Спот за вграждане направляем с LED COB, алуминиева структура, боядисана в бяло електростатично поле, алуминиев рефлектор и разсейвател от прозрачен поликарбонат. Комплект оборудван със захранващо устройство.

SK - Orientovateľný zapustený COB LED reflektor, hliníková konštrukcia elektrostaticky maľovaná v bielej farbe, hliníkový reflektor a polykarbonátový difúzor. Súčasťou je napájač.

MT 129 LED

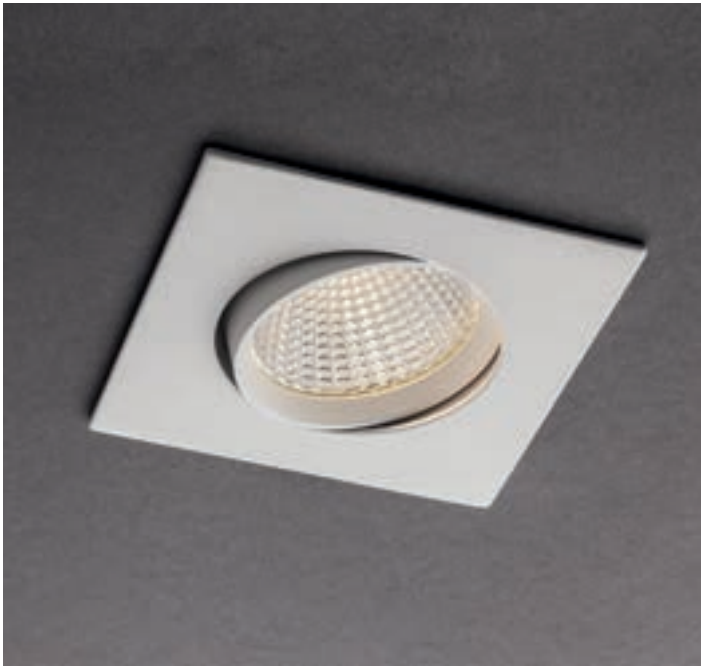

art. **70365** WH White



art. **70366** AL Aluminium

COB LED · 5W · 4000K · CRI 80
LED flux 508 lm
Luminaire flux 368 lm
Optic 45°



Ø75 mm

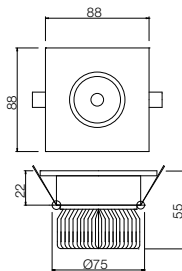

Orientable recessed COB LED downlight, structure and reflector of aluminium, polycarbonate diffuser. Driver included.

RO - Spot de încastrat orientabil cu LED COB, structură din aluminiu, reflector din aluminiu și dispersor din policarbonat transparent. Complet echipat cu alimentator.

IT - Incasso orientabile a LED, struttura in alluminio, rifletore in alluminio e diffusore in policarbonato. Dotato di driver.

RU - Управляемое встраиваемое световое пятно со светодиодами LED COB, алюминиевая конструкция, окрашенная в электростатическом поле, белого цвета, алюминиевый отражатель и диффузор из поликарбоната. Полностью оснащено фидером.

HU - Beépíthető és billenthető COB LED lámpa, elektrosztatikus térben fehérre festett alumínium szerkezettel, alumínium fényszóróval és áttetsző polikarbonát diszperzórral. Táppal ellátott szerkezet.

BG - Спот за вграждане направляем с LED COB, алуминиева структура, боядисана в бяло електростатично поле, алуминиев рефлектор и разсейвател от прозрачен поликарбонат. Комплект оборудван със захранващо устройство.

SK - Orientovateľný zapustený COB LED reflektor, hliníková konštrukcia elektrostaticky maľovaná v bielej farbe, hliníkový reflektor a polykarbonátový difúzor. Súčasťou je napájač.

MT 115 LED



art. 70316 MWH Mat White



art. 70317 AL Aluminium

POWER LED · 3 x 1W · 4000K · CRI 80
LED flux 305 lm
Luminaire flux 248 lm
Optic 45°



Ø66 mm

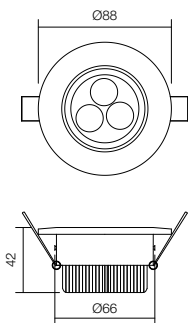

Orientable recessed LEDs downlight, aluminium structure, polycarbonate lens. Equipped with driver.

RO · Spot de încastrat orientabil cu LED-uri, structură din aluminiu și lentilă din policarbonat. Complet echipat cu alimentator.

IT · Incasso orientabile a LED, struttura in alluminio e lente in policarbonato. Dotato di driver.

RU · Направляемый встраиваемый светодиодный spot, алюминиевая структура, поликарбонатная линза. Полностью оснащен с блоком питания.

HU · Beépíthető, állítható irányú LED-es spot, elektrosztatikus mezőben fehérre festett alumínium szerkezet polikarbonát lencsével. Teljesen felszerelve tápforrással.

BG · Ориентируем прожектор за вграждане с LED-ове, алуминиева структура, леща от поликарбонат. Напълно оборудван със захранващо устройство.

SK · Nastaviteľné zapustené LED bodové svetlo, konštrukcia z hliníka a polykarbonátovej šošovky. Súčasťou je napájač.

MT 116 LED

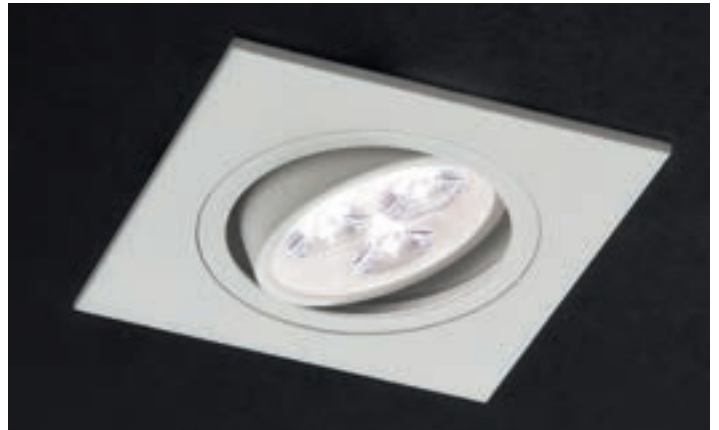

art. 70318 MWH Mat White



art. 70319 AL Aluminium

POWER LED · 3 x 1W · 4000K · CRI 80
LED flux 305 lm
Luminaire flux 248 lm
Optic 45°



Ø66 mm

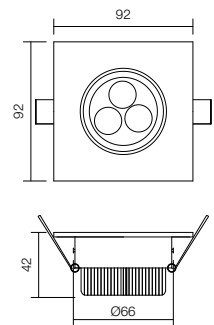

Orientable recessed LEDs downlight, aluminium structure, polycarbonate lens. Equipped with driver.

RO · Spot de încastrat orientabil cu LED-uri, structură din aluminiu și lentilă din policarbonat. Complet echipat cu alimentator.

IT · Incasso orientabile a LED, struttura in alluminio e lente in policarbonato. Dotato di driver.

RU · Направляемый встраиваемый светодиодный spot, алюминиевая структура, поликарбонатная линза. Полностью оснащен с блоком питания.

HU · Beépíthető, állítható irányú LED-es spot, elektrosztatikus mezőben fehérre festett alumínium szerkezet polikarbonát lencsével. Teljesen felszerelve tápforrással.

BG · Ориентируем прожектор за вграждане с LED-ове, алуминиева структура, леща от поликарбонат. Напълно оборудван със захранващо устройство.

SK · Nastaviteľné zapustené LED bodové svetlo, konštrukcia z hliníka a polykarbonátovej šošovky. Súčasťou je napájač.

MT 141 LED



art. **70367** WH White

COB LED · 3W · 4000K · CRI 80
LED FLUX 305 lm
Luminaire flux 191 lm
Optic 45°

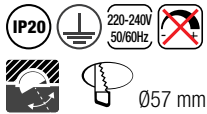

Ø57 mm

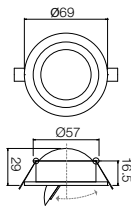

Orientable recessed COB LED downlight, aluminium structure electrostatically painted in white, aluminium reflector and polycarbonate diffuser. Driver included.

RO · Spot de încastrat orientabil cu LED COB, structură din aluminiu vopsită în câmp electrostatic alb, reflector din aluminiu și dispersor din policarbonat transparent. Complet echipat cu alimentator.

IT · Incasso orientabile a LED, struttura in alluminio verniciato a polveri bianco, riflettore in alluminio e diffusore in policarbonato. Dotato di driver.

RU · Управляемое встраиваемое световое пятно со светодиодами LED COB, алюминиевая конструкция, окрашенная в электростатическом поле, белого цвета, алюминиевый отражатель и диффузор из поликарбоната. Полностью оснащено фидером.

HU · Beépíthető és billenthető COB LED lámpa, elektrosztatikus térben fehérre festett alumínium szerkezettel, alumínium fényszórával és áttetsző polikarbonát diszperzórral. Táppal ellátott szerkezet.

BG · Спот за вграждане направляем с LED COB, алуминиева структура, боядисана в бяло електристатично поле, алуминиев рефлектор и разсейвател от прозрачен поликарбонат. Комплект оборудван със захранващо устройство.

SK · Orientovateľný zapustený COB LED reflektor, hliníková konštrukcia elektrostaticky maľovaná v bielej farbe, hliníkový reflektor a polykarbonátový difúzor. Súčasťou je napájač.

MT124 LED



art. 70359 WH White

COB LED · 3W · 4000K · CRI 80
LED flux 305 lm
Luminaire flux 162 lm
Optic 45°

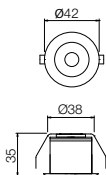

Ø38 mm

Recessed LED downlight, aluminium structure electrostatically painted in white, polycarbonate diffuser. Equipped with driver.

RO · Spot de încastrat cu LED, structură din aluminiu vopsită în câmp electrostatic culoare albă, dispersor din policarbonat. Complet echipat cu alimentator.

IT · Incasso fisso a LED, struttura in alluminio verniciato a polveri bianco, diffusore in policarbonato. Dotato di driver.

RU · Направляемый встраиваемый светодиодный спот, алюминиевая структура, окрашенная в электростатическом поле белого цвета, поликарбонатная линза. Полностью оснащен с блоком питания.

HU · Beépíthető LED-es spot, elektrosztatikus mezőben fehérre festett alumínium szerkezet polikarbonát lencsével. Teljesen felszerelve tápforrással.

BG · Прожектор за вграждане с LED-ове, алуминиева структура, боядисана в бяло електростатично поле, леща от поликарбонат. Напълно оборудван със захранващо устройство.

SK · Zapustené LED bodové svetlo, hliníková konštrukcia elektrostaticky lakovaná v bielej farbe, polykarbonátový difúzor. Súčasťou je napájač.

MT125 LED



art. 70360 WH White

COB LED · 3W · 4000K · CRI 80
LED flux 305 lm
Luminaire flux 162 lm
Optic 45°

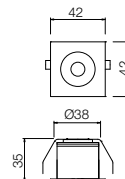

Ø38 mm

Recessed LED downlight, aluminium structure electrostatically painted in white colour, polycarbonate diffuser. Equipped with driver.

RO · Spot de încastrat cu LED, structură din aluminiu vopsită în câmp electrostatic culoare albă, dispersor din policarbonat. Complet echipat cu alimentator.

IT · Incasso fisso a LED, struttura in alluminio verniciato a polveri bianco, diffusore in policarbonato. Dotato di driver.

RU · Направляемый встраиваемый светодиодный спот, алюминиевая структура, окрашенная в электростатическом поле белого цвета, поликарбонатная линза. Полностью оснащен с блоком питания.

HU · Beépíthető LED-es spot, elektrosztatikus mezőben fehérre festett alumínium szerkezet polikarbonát lencsével. Teljesen felszerelve tápforrással.

BG · Прожектор за вграждане с LED-ове, алуминиева структура, боядисана в бяло електростатично поле, леща от поликарбонат. Напълно оборудван със захранващо устройство.

SK · Zapustené LED bodové svetlo, hliníková konštrukcia elektrostaticky lakovaná v bielej farbe, polykarbonátový difúzor. Súčasťou je napájač.

MT 126 LED



art. **70361** WH White

COB LED · 3W · 4000K · CRI 80
LED flux 305 lm
Luminaire flux 162 lm
Optic 45°

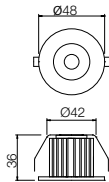

Ø42 mm

Recessed LED downlight, aluminium structure electrostatically painted in white, polycarbonate diffuser. Equipped with driver.

RO · Spot de încadrat cu LED, structură din aluminiu vopsită în câmp electrostatic culoare albă, dispersor din policarbonat. Complet echipat cu alimentator.

IT · Incasso fisso a LED, struttura in alluminio verniciato a polveri bianco, diffusore in policarbonato. Dotato di driver.

RU · Направляемый встраиваемый светодиодный спот, алюминиевая структура, окрашенная в электростатическом поле белого цвета, поликарбонатная линза. Полностью оснащен с блоком питания.

HU · Beépíthető LED-es spot, elektrosztatikus mezőben fehérre festett alumínium szerkezet polikarbonát lencsével. Teljesen felszerelve tápforrással.

BG · Прожектор за вграждане с LED-ове, алуминиева структура, боядисана в бяло электростатично поле, леща от поликарбонат. Напълно оборудван със захранващо устройство.

SK · Zapustené LED bodové svetlo, hliníková konštrukcia elektrostaticky lakovaná v bielej farbe, polykarbonátový difúzor. Súčasťou je napájač.

MT 127 LED



art. **70362** WH White

COB LED · 3W · 4000K · CRI 80
LED flux 305 lm
Luminaire flux 162 lm
Optic 45°

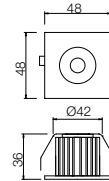
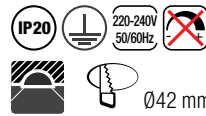

Ø42 mm

Recessed LED downlight, aluminium structure electrostatically painted in white, polycarbonate diffuser. Equipped with driver.

RO · Spot de încadrat cu LED, structură din aluminiu vopsită în câmp electrostatic culoare albă, dispersor din policarbonat. Complet echipat cu alimentator.

IT · Incasso fisso a LED, struttura in alluminio verniciato a polveri bianco, diffusore in policarbonato. Dotato di driver.

RU · Направляемый встраиваемый светодиодный спот, алюминиевая структура, окрашенная в электростатическом поле белого цвета, поликарбонатная линза. Полностью оснащен с блоком питания.

HU · Beépíthető LED-es spot, elektrosztatikus mezőben fehérre festett alumínium szerkezet polikarbonát lencsével. Teljesen felszerelve tápforrással.

BG · Прожектор за вграждане с LED-ове, алуминиева структура, боядисана в бяло электростатично поле, леща от поликарбонат. Напълно оборудван със захранващо устройство.

SK · Zapustené LED bodové svetlo, hliníková konštrukcia elektrostaticky lakovaná v bielej farbe, polykarbonátový difúzor. Súčasťou je napájač.

MT 119 LED



art. **70324** MWH Mat White



art. **70325** AL Aluminium

POWER LED · 1W · 4000K · CRI 80
LED flux 109 lm
Luminaire flux 67 lm
Optic 45°



Ø43 mm

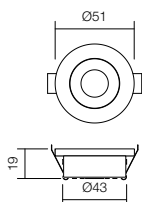

Orientable recessed LED downlight, aluminium structure, polycarbonate lens. Equipped with driver.

RO · Spot de încastrat orientabil cu LED-uri, structură din aluminiu și lentilă din policarbonat. Complet echipat cu alimentator.

IT · Incasso orientabile a LED, struttura in alluminio e lente in policarbonato. Dotato di driver.

RU · Направляемый встраиваемый светодиодный spot, алюминиевая структура, поликарбонатная линза. Полностью оснащен с блоком питания.

HU · Beépíthető, állítható irányú LED-es spot, alumínium szerkezet polikarbonát lencsével. Teljesen felszerelve tápforrással.

BG · Ориентируем прожектор за вграждане с LED-ове, алуминиева структура, леща от поликарбонат. Напълно оборудван със захранващо устройство.

SK · Nastaviteľné zapustené LED bodové svetlo, konštrukcia z hliníka a polykarbonátové šošovky. Súčasťou je napájač.

MT 120 LED

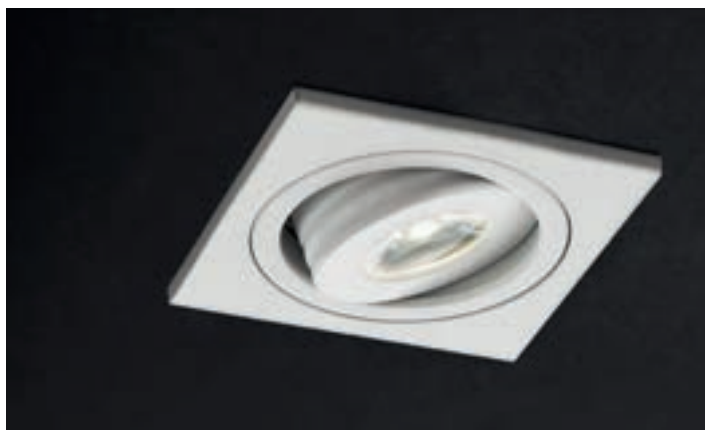

art. **70326** MWH Mat White



art. **70327** AL Aluminium

POWER LED · 1W · 4000K · CRI 80
LED flux 109 lm
Luminaire flux 67 lm
Optic 45°



Ø45 mm

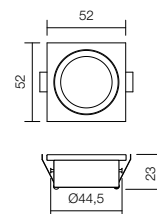

Orientable recessed LED downlight, aluminium structure, polycarbonate lens. Equipped with driver.

RO · Spot de încastrat orientabil cu LED-uri, structură din aluminiu și lentilă din policarbonat. Complet echipat cu alimentator.

IT · Incasso orientabile a LED, struttura in alluminio e lente in policarbonato. Dotato di driver.

RU · Направляемый встраиваемый светодиодный spot, алюминиевая структура, поликарбонатная линза. Полностью оснащен с блоком питания.

HU · Beépíthető, állítható irányú LED-es spot, alumínium szerkezet polikarbonát lencsével. Teljesen felszerelve tápforrással.

BG · Ориентируем прожектор за вграждане с LED-ове, алуминиева структура, леща от поликарбонат. Напълно оборудван със захранващо устройство.

SK · Nastaviteľné zapustené LED bodové svetlo, konštrukcia z hliníka a polykarbonátové šošovky. Súčasťou je napájač.

MT 117 LED



art. **70320** MWH Mat White



art. **70321** AL Aluminium

POWER LED · 1W · 4000K · CRI 80
LED flux 109 lm
Luminaire flux 67 lm
Optic 45°



Ø26 mm

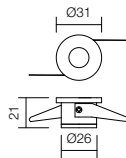

Recessed LED downlight, aluminium structure, polycarbonate lens. Equipped with driver.

RO · Spot de încadrat cu LED-uri, structură din aluminiu și lentilă din policarbonat. Complet echipat cu alimentator.

IT · Incasso fisso a LED, struttura in alluminio e lente in policarbonato. Dotato di driver.

RU · Направляемый встраиваемый светодиодный спот, алюминиевая структура, поликарбонатная линза. Полностью оснащен с блоком питания.

HU · Beépíthető LED-es spot, alumínium szerkezet polikarbonát lencsével. Teljesen felszerelve tápforrással.

BG · Прожектор за вграждане с LED-ове, алуминиева структура, леща от поликарбонат. Напълно оборудван със захранващо устройство.

SK · Zapustené LED bodové svetlo, hliníková štruktúra a polykarbonátové šošovky. Súčasťou je napájač.

MT 118 LED



art. **70322** MWH Mat White

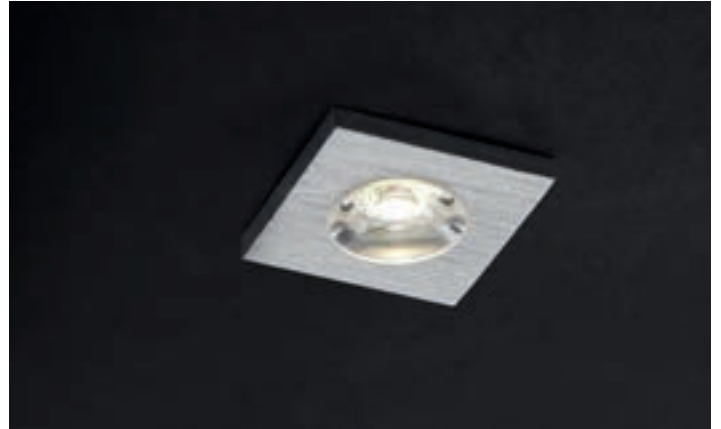

art. **70323** AL Aluminium

POWER LED · 1W · 4000K · CRI 80
LED flux 109 lm
Luminaire flux 67 lm
Optic 45°

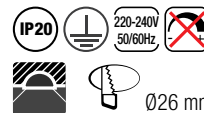

Ø26 mm

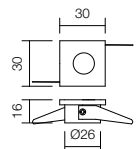

Recessed LED downlight, aluminium structure, polycarbonate lens. Equipped with driver.

RO · Spot de încadrat cu LED-uri, structură din aluminiu și lentilă din policarbonat. Complet echipat cu alimentator.

IT · Incasso fisso a LED, struttura in alluminio e lente in policarbonato. Dotato di driver.

RU · Направляемый встраиваемый светодиодный спот, алюминиевая структура, поликарбонатная линза. Полностью оснащен с блоком питания.

HU · Beépíthető LED-es spot, alumínium szerkezet polikarbonát lencsével. Teljesen felszerelve tápforrással.

BG · Прожектор за вграждане с LED-ове, алуминиева структура, леща от поликарбонат. Напълно оборудван със захранващо устройство.

SK · Zapustené LED bodové svetlo, hliníková štruktúra a polykarbonátové šošovky. Súčasťou je napájač.

PT 01



art. **70392** MWH Mat White



GU10, 1 x max. 50W

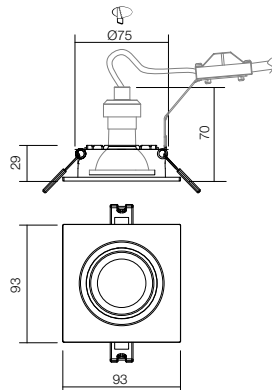

Built-in orientable downlight for interior, mat white plastic structure, with anti-yellow treatment, 5 years gurantee.

RO - Spot de încastrat orientabil pentru interior, structură din plastic alb mat, tratat anti-îngălbenire, garanție 5 ani.

IT - Incasso orientabile per interni, struttura in plastica bianca opaca, con trattamento anti giallimento, garanzia 5 anni.

RU - Встроенный ориентируемый спот светильник для интерьера, матовая белая пластиковая структура, анти-желтеющая обработка, гарантия 5 лет.

HU - Beltéri besülyeszett mozgatható spot lámpa, matt fehér műanyag szerkezet, besárgulás ellen kezelve, 5 év garancia.

BG - Регулируем спот вграждане, структура от матова бяла пластмаса, третиран срещу пожълтяване, 5 години гаранция.

SK - Vstavané orientovateľné stropné svetlo do interiéru, matná biela plastová konštrukcia, s úpravou proti zažltnutiu, záruka 5 rokov.

PT 02



art. **70393** MWH Mat White



GU10, 2 x max. 50W

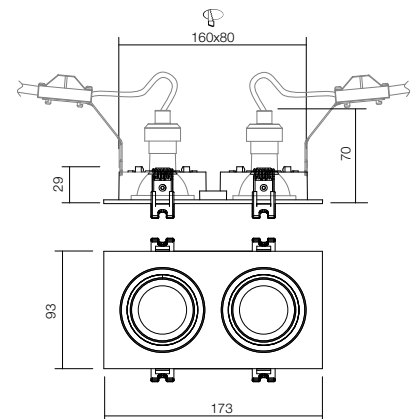

Built-in orientable downlight for interior, mat white plastic structure, with anti-yellow treatment, 5 years gurantee.

RO - Spot de încastrat orientabil pentru interior, structură din plastic alb mat, tratat anti-îngălbenire, garanție 5 ani.

IT - Incasso orientabile per interni, struttura in plastica bianca opaca, con trattamento anti giallimento, garanzia 5 anni.

RU - Встроенный ориентируемый спот светильник для интерьера, матовая белая пластиковая структура, анти-желтеющая обработка, гарантия 5 лет.

HU - Beltéri besülyeszett mozgatható spot lámpa, matt fehér műanyag szerkezet, besárgulás ellen kezelve, 5 év garancia.

BG - Регулируем спот вграждане, структура от матова бяла пластмаса, третиран срещу пожълтяване, 5 години гаранция.

SK - Vstavané orientovateľné stropné svetlo do interiéru, matná biela plastová konštrukcia, s úpravou proti zažltnutiu, záruka 5 rokov.

PT 03



art. **70394** MWH Mat White



GU10, 3 x max. 50W

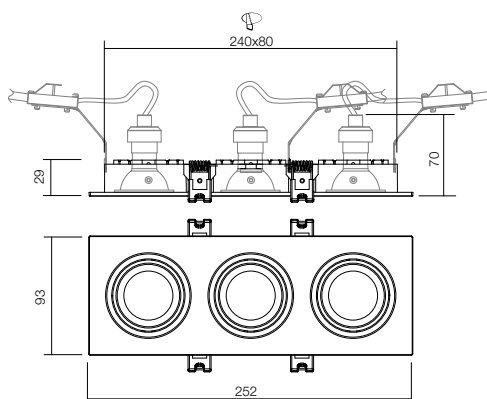
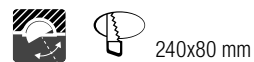

Built-in orientable downlight for interior, mat white plastic structure, with anti-yellow treatment, 5 years gurantee.

RO · Spot de încadrat orientabil pentru interior, structură din plastic alb mat, tratat anti-îngălbenire, garanție 5 ani.

IT · Incasso orientabile per interni, struttura in plastica bianca opaca, con trattamento anti giallimento, garanzia 5 anni.

RU · Встроенный ориентируемый спот светильник для интерьера, матовая белая пластиковая структура, анти-желтеющая обработка, гарантия 5 лет.

HU · Beltéri besülyeszett mozgatható spot lámpa, matt fehér műanyag szerkezet, besárgulás ellen kezelve, 5 év garancia.

BG · Регулируем спот вграждане, структура от матова бяла пластмаса, третиран срещу пожълтяване, 5 години гаранция.

SK · Vstavané orientovateľné stropné svetlo do interiéru, matná biela plastová konštrukcia, s úpravou proti zažltnutiu, záruka 5 rokov.

ELC 2374



art. **70315** MWH Mat White



art. **70083** NM Nickel Mat

GU10, 1 x max. 50W



80 x 80 mm

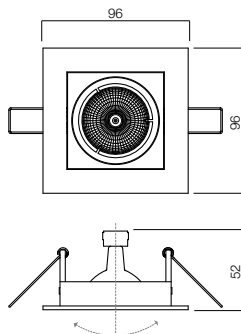

Built-in orientable downlight, zamak structure.

RO · Spot de încastrat orientabil din zamac.

IT · Incasso orientabile in fusione di zama.

RU · Подвижное встроенное световое пятно из медных сплавов.

HU · Zamakból készült beállítható beépített spot.

BG · Насочващ се вграден спот от замък.

SK · Vstavaný smerovateľný reflektor so Zamak štruktúrou.

ELC 146



art. **70009** CH Chrome



art. **70008**
WH White



art. **70082**
NM Nickel Mat



art. **70010**
PB Polish Brass



art. **70238**
AB Antique Brass



art. **70095**
RAB Red Antique Brass



art. **70013**
PS/G Pearl Silver/Gold



art. **70012**
PG/S Pearl Gold/Silver



art. **70014**
PC/CH Pearl Chrome/Chrome



art. **70011**
CM/CH Gun Metal/Chrome

GU10, 1 x max. 50W

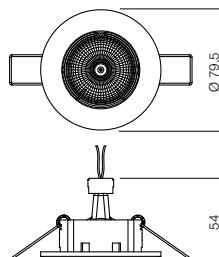

Fixed built-in downlight, zamak structure.

RO - Spot de încastrat fix, din zamak.

IT - Incasso fisso in fusione di zama.

RU - Неподвижное встроенное световое пятно из медных сплавов.

HU - Zamakból készült merev beépített spot.

BG - Фиксиран вграден спот, от замак.

SK - Pevný vstavaný reflektor so Zamak štruktúrou.

ELC 229



art. **70001** WH White



art. **70081**
NM Nickel Mat



art. **70002**
CH Chrome



art. **70237**
AB Antique Brass

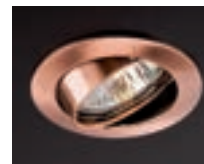

art. **70094**
RAB Red Antique Brass



art. **70005**
PG/S Pearl Gold/Silver



art. **70007**
PC/CH Pearl Chrome/Chrome



art. **70003**
PB Polish Brass



art. **70006**
PS/G Pearl Silver/Gold



art. **70004**
GM/CH Gun Metal/Chrome

GU10, 1 x max. 50W

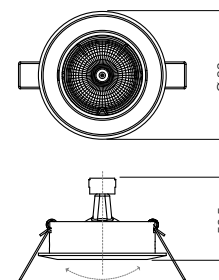

Built-in orientable downlight, zamak structure.

RO - Spot de încastrat orientabil din zamak.

IT - Incasso orientabile in fusione di zama.

RU - Подвижное встроенное световое пятно из медных сплавов.

HU - Zamakból készült beállítható beépített spot.

BG - Насочващ се вграден спот от замак.

SK - Vstavaný smerovateľný reflektor, Zamak štruktúra.

MT 122

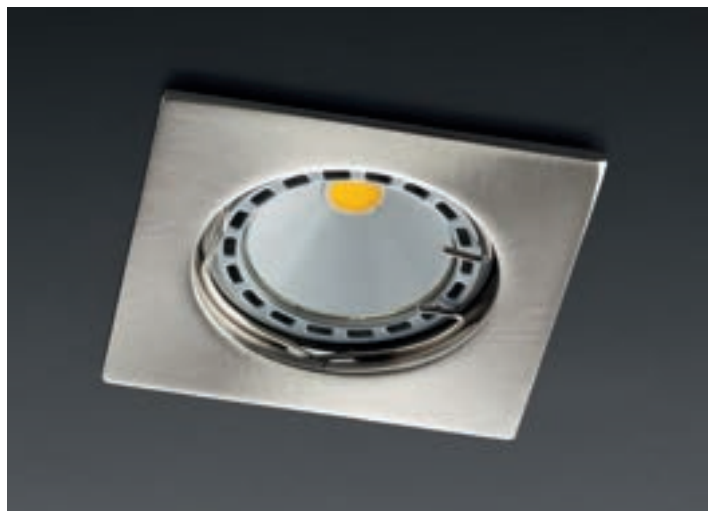

art. **70331** NM Nickel Mat



art. **70330**
MWH Mat White



art. **70328**
CH Chrome



art. **70334**
AB Antique Brass



art. **70333**
RAB Red Antique Brass



art. **70332**
PC/CH Pearl Chrome/Chrome



art. **70329**
GM/CH Gun Metal/Chrome

GU10, 1 x max. 50W

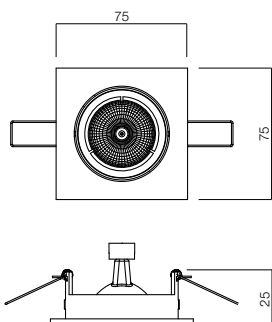

Fixed built-in downlight, aluminium structure.

RO · Spot de încastrat fix cu structură din aluminiu.

IT · Incasso fisso con struttura in alluminio.

RU · Неподвижное встроенное световое пятно с алюминиевой структурой.

HU · Alumínium szerkezetű merev beépített spot.

BG · Фиксиран вграден спот от алуминий.

SK · Pevný vstavaný reflektor s hliníkovou konštrukciou.

MT 123

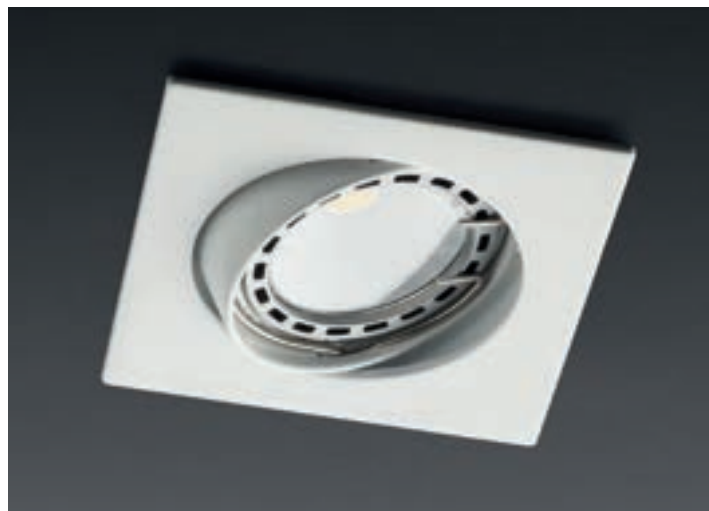

art. **70337** MWH Mat White



art. **70338**
NM Nickel Mat



art. **70335**
CH Chrome



art. **70341**
AB Antique Brass



art. **70340**
RAB Red Antique Brass



art. **70339**
PC/CH Pearl Chrome/Chrome



art. **70336**
GM/CH Gun Metal/Chrome

GU10, 1 x max. 50W

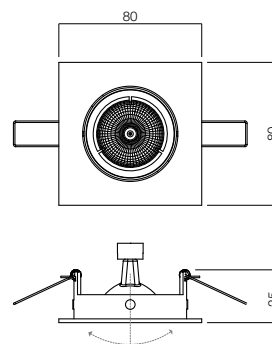

Built-in orientable downlight, aluminium structure.

RO · Spot de încastrat orientabil din aluminiu.

IT · Incasso orientabile in alluminio.

RU · Подвижное встроенное световое пятно с алюминиевой структурой.

HU · Alumíniumból készült beállítható beépített spot.

BG · Насочващ се вграден спот от алуминий.

SK · Vstavaný smerovateľný reflektor s hliníkovou konštrukciou.

ELC 104



art. **70058** CH Chrome



art. **70057** PC/CH Pearl Chrome/Chrome

Built-in orientable downlight, zamak structure.

RO · Spot de încadrat orientabil din zamac.

IT · Incasso orientabile, struttura in fusione di zama.

RU · Подвижное встроенное световое пятно из медных сплавов.

HU · Zamakból készült beállítható beépített spot.

BG · Насочващ се вграден спот със замък.

SK · Vstavaný smerovateľný reflektor so Zamak štruktúrou.

GU10, 1 x max. 50W



Ø72 mm

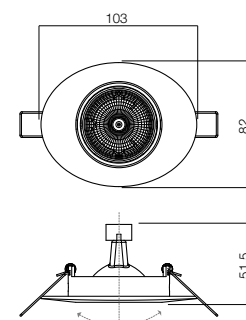

ELC307

art. **70147** WH Whiteart. **70148** CH Chromeart. **70150** MC Mat Chromeart. **70152** GM Gun Metalart. **70149** PB Polish Brassart. **70151** MB Mat Brass

GU10, 1 x max. 50W



Ø60 mm

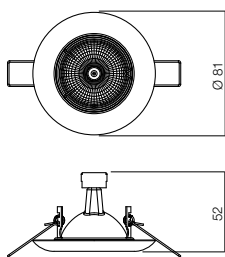

Fixed built-in downlight, metal structure.

RO · Spot de încastrat fix cu structură din metal.

IT · Incasso fisso con struttura in metallo.

RU · Неподвижное встроенное световое пятно с металлической структурой.

HU · Fém szerkezetű merev beépített spot.

BG · Фиксиран вграден спот с метална структура.

SK · Pevný vstavaný reflektor s kovovou konštrukciou.

ELC 3072

art. **70153** WH Whiteart. **70154** CH Chromeart. **70156** MC Mat Chromeart. **70158** GM Gun Metalart. **70155** PB Polish Brassart. **70157** MB Mat Brass

GU10, 1 x max. 50W

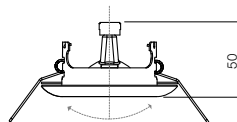
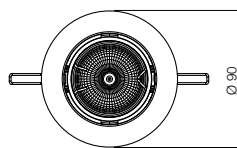

Built-in orientable downlight, metal structure.

RO - Spot de încastrat orientabil, cu structură din metal.

IT - Incasso orientabile con struttura in metallo.

RU - Подвижное встроенное световое пятно с металлической структурой.

HU - Fém szerkezetű beállítható beépített spot.

BG - Насочващ се вграден спот с метална структура.

SK - Vstavaný smerovateľný reflektor s kovovou konštrukciou.

MT 112



art. 70307 WH White



art. 70308 CH Chrome



art. 70309 NM Nickel Mat



art. 70310 AB Antique Brass

Fixed built-in downlight, metal structure.

RO · Spot de încastrat fix cu structură din metal.

IT · Incasso fisso con struttura in metallo.

RU · Неподвижное встроенное световое пятно с металлической структурой.

HU · Fém szerkezetű merev beépített spot.

BG · Фиксиран вграден спот с метална структура.

SK · Pevný vstavaný reflektor s kovovou konštrukciou.

GU5.3, 1 x max. 50W

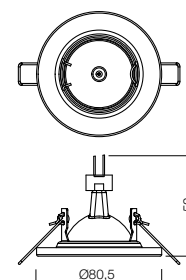

MT 101



art. **70194** CH Chrome



art. **70196** AB Antique Brass



art. **70197** RAB Red Antique Brass



art. **70195** PB Polish Brass

GU10, 1 x max. 50W

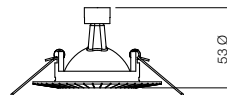
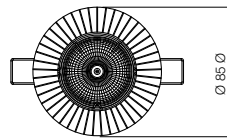

Fixed built-in downlight, aluminium structure.

RO · Spot de încastrat fix cu structură din aluminiu.

IT · Incasso fisso con struttura in alluminio.

RU · Неподвижное встроенное световое пятно с алюминиевой структурой.

HU · Alumínium szerkezetű merev beépített spot.

BG · Фиксиран вграден спот от алуминий.

SK · Pevný vstavaný reflektor s hliníkovou konštrukciou.

ELC 329



art. **70098** S/PG Silver/Pearl Gold



art. **70097** G/PS Gold/Pearl Silver



art. **70096** CH/PC Chrome/Pearl Chrome



art. **70099** G/GM Gold/Gun Metal

GU10, 1 x max. 50W

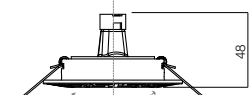
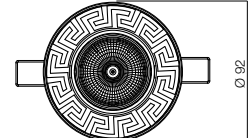

Built-in orientable downlight, zamak structure.

RO · Spot de încastrat orientabil din zamac.

IT · Incasso orientabile in fusione di zama.

RU · Подвижное встроенное световое пятно из медных сплавов.

HU · Zamakból készült beállítható beépített spot.

BG · Насочващ се вграден спот от замък.

SK · Vstavané smerovateľné bodové svetlo so štruktúrou Zamak.

ELC 127

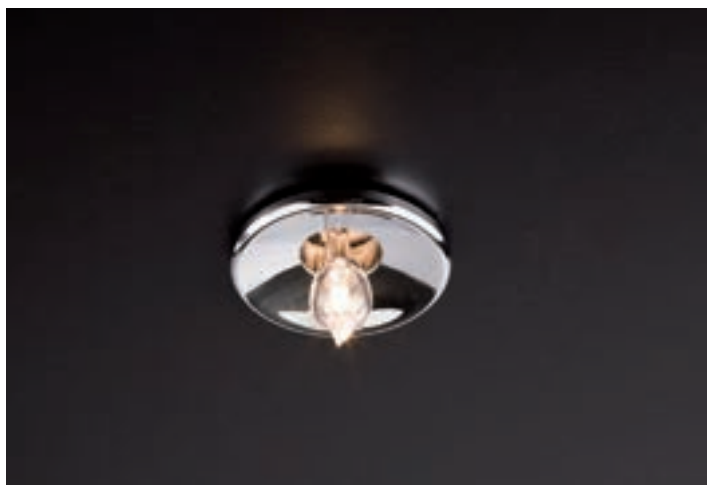

art. 70141 CH Chrome



art. 70142 SB Satin Brass

G4, 1 x max. 20W



Ø25 mm

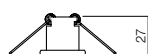

Fixed built-in downlight, zamak structure.

RO · Spot de încastrat fix, din zamac.

IT · Incasso fisso, struttura in fusione di zama.

RU · Неподвижное встроенное световое пятно из медных сплавов.

HU · Zamakból készült merev beépített spot.

BG · Фиксиран вграден спот, от замък.

SK · Pevný vstavaný reflektor so Zamak štruktúrou.

ELC 015



art. 70031 CH Chrome

G4, 1 x max. 20W



Ø55 mm

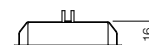
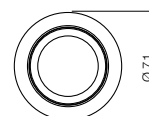

Fixed built-in downlight, metal structure, glass diffuser, specially for furniture.

RO · Spot de încastrat fix cu structură din metal, dispersor din sticlă, special pentru mobilă.

IT · Incasso fisso con struttura in metallo, diffusore in vetro, speciale per mobili.

RU · Неподвижное встроенное световое пятно с металлической структурой, диффузор: стекло, специальный для мебели.

HU · Krómozott fém szerkezetű merev beépített spot, üveg diszperzör, különösen a bútorszámára.

BG · Фиксиран вграден спот с метална структура, стъклен разпръсквач, специално за мебели.

SK · Pevný vstavaný reflektor s kovovou konštrukciou, sklenený difúzor, vhodné pre inštaláciu do nábytku.

MT 142 LED



Mat White



CH Chrome



S Silver

Downlights equipped with SMD LEDs, recessed or surface mounting, aluminium structure painted in white, chrome or silver, frost polycarbonate diffuser, driver included.

RO · Spoturi echipate cu LED-uri SMD, pentru montaj încastrat sau aparent, structură din aluminiu în versiuni alb, crom sau argintiu, dispersor din policarbonat satinat, alimentator inclus.

IT · Incassi equipaggiati con LED SMD, montaggio ad incasso o da superficie, struttura in alluminio verniciato bianco, cromato o argento, diffusore in policarbonato satinato, dotato di driver.

RU · Встраиваемые светодиодные светильники, алюминиевая конструкция, окрашенная в белый цвет, хром или серебро, рассеиватель из поликарбоната. Оснащены драйверами.

HU · Besülyeszett LED spot, fehér, króm vagy ezüst alumínium szerkezet polikarbonát lencsével, működőtétővel ellátva.

BG · Светодиодни лунни за вграждане от алуминий, боядисан в бяло, хром или сребърно, дифузер от поликарбонат, комплектовани с драйвер.

SK · Zápusťné LED svietidlá, so zapustenou alebo povrchovou montážou, hliníková štruktúra v bielej, chrómovej alebo striebornej farbe, polykarbonátový difúzor, obsahujú napájač.



SURFACE MOUNTING

RECESSED MOUNTING

art. **70368** MWH Mat White
art. **70369** CH Chrome
art. **70370** S Silver

SMD LED · 3W · 4000K · CRI 85
LED flux 308 lm
Luminaire flux 204 lm



art. **70371** MWH Mat White
art. **70372** CH Chrome
art. **70373** S Silver

SMD LED · 3W · 3000K · CRI 85
LED flux 305 lm
Luminaire flux 200 lm



SURFACE OR RECESSED MOUNTING

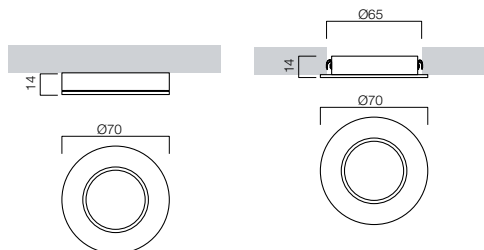

CR18 CH



art. **70220** Crystal

GU10, 1 x max. 50W

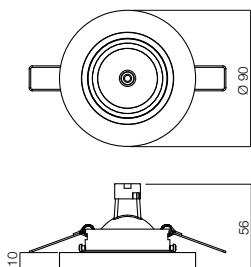

Fixed built-in downlight with chromed metal structure, crystal diffuser.

RO · Spot de încastrat fix cu structură din metal cromat, dispersor din cristal.

IT · Incasso fisso con struttura in metallo cromato, diffusore in cristallo.

RU · Неподвижное встроенное световое пятно с металлической хромированной структурой, диффузор: хрусталь.

HU · Krómzott fém szerkezetű merev beépített spot, kristály diszperzór.

BG · Фиксиран вграден спот с хромна метална структура, разпръсквач от кристал.

SK · Pevný vstavaný reflektor s chrómovou kovovou konštrukciou, krištáľový difúzor.

CR 34 LED



art. 70311 Glass

POWER LED · 3 x 1W · 4000K · CRI 80
LED flux 303 lm
Luminaire flux 248 lm
Optic 45°

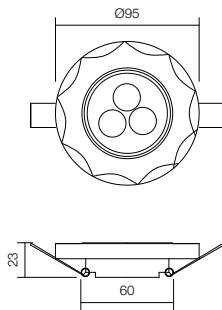

Recessed LEDs downlight, aluminium structure with transparent faceted glass frame. Equipped with driver.

RO · Spot de încadrat cu LED-uri, structură din aluminiu cu ramă din sticlă fațetată transparentă. Complet echipat cu alimentator.

IT · Incasso fisso a LED, struttura in alluminio con cornice in vetro trasparente sfaccettato. Dotato di driver.

RU · Встраиваемый светодиодный спот, алюминиевая структура с прозрачной граненой стеклянной рамкой. Полностью оснащен с блоком питания.

HU · Beépíthető LED-es spot, alumínium szerkezet csiszolt áttetsző üveg kerettel. Teljesen felszerelve tápforrással.

BG · Прожектор за вграждане с LED-ове, алуминиева структура с рамка от прозрачно фасетирано стъкло. Напълно оборудван със захранващо устройство.

SK · Zapustené LED bodové svetlo, hliníková konštrukcia s priehľadným brúseným skleneným rámom. Súčasťou je napájač.

CR 35 LED

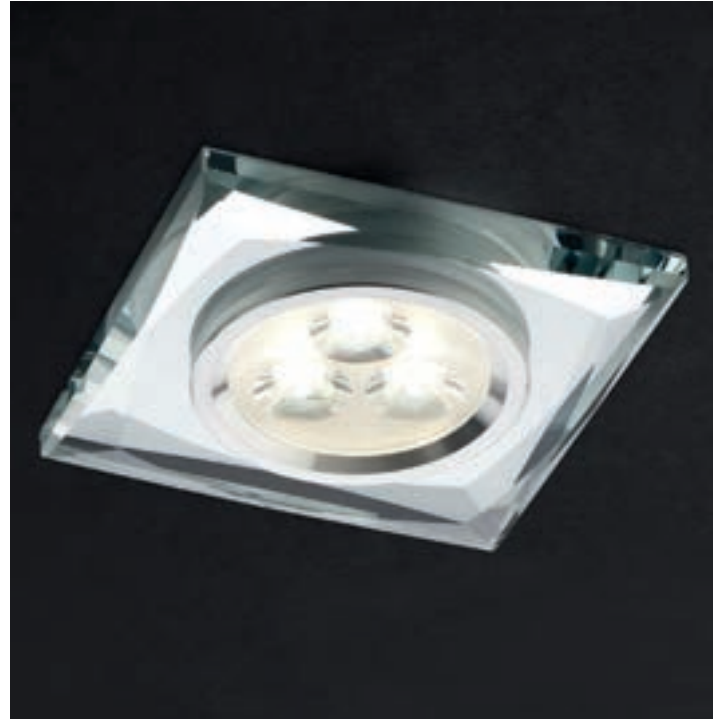

art. 70313 Glass

POWER LED · 3 x 1W · 4000K · CRI 80
LED flux 303 lm
Luminaire flux 248 lm
Optic 45°

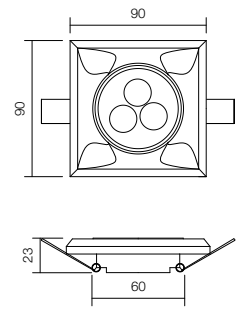

Recessed LEDs downlight, aluminium structure with transparent faceted glass frame. Equipped with driver.

RO · Spot de încadrat cu LED-uri, structură din aluminiu cu ramă din sticlă fațetată transparentă. Complet echipat cu alimentator.

IT · Incasso fisso a LED, struttura in alluminio con cornice in vetro trasparente sfaccettato. Dotato di driver.

RU · Встраиваемый светодиодный спот, алюминиевая структура с прозрачной граненой стеклянной рамкой. Полностью оснащен с блоком питания.

HU · Beépíthető LED-es spot, alumínium szerkezet csiszolt áttetsző üveg kerettel. Teljesen felszerelve tápforrással.

BG · Прожектор за вграждане с LED-ове, алуминиева структура с рамка от прозрачно фасетирано стъкло. Напълно оборудван със захранващо устройство.

SK · Zapustené LED bodové svetlo, hliníková konštrukcia s priehľadným brúseným skleneným rámom. Súčasťou je napájač.

CR 27art. **70288** Crystal

GU10, 1 x max. 50W

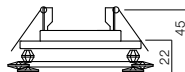
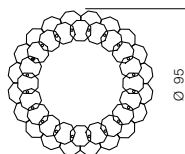

Ø65 mm

**Fixed built-in downlight with chromed metal structure and crystal decoration.**

RO · Spot de încastrat fix cu structură din metal cromat cu decorațiuni din cristal.

IT · Incasso fisso con struttura in metallo cromato, decorazioni in cristallo.

RU · Неподвижное встроенное световое пятно с металлической хромированной структурой, с хрустальными декорами.

HU · Krómozott fém szerkezetű merev beépített spot, kristály díszítéssel.

BG · Фиксиран вграден спот с хромирана метална структура, с кристални украси.

SK · Pevný vstavaný reflektor s chrómovanou kovovou konštrukciou s krištáľovou dekoráciou.

CR 36



art. **70344** Crystal

GU10, 1 x max. 50W

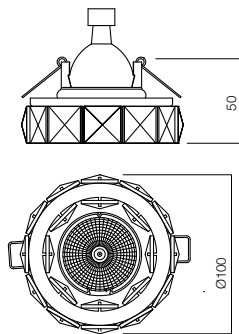

Fixed built-in downlight with chromed metal structure and crystal decoration.

RO · Spot de încastrat fix, structură din metal cromat cu decorațiuni din cristal.

IT · Incasso fisso con struttura in metallo cromato, decorazioni in cristallo.

RU · Неподвижное встроенное световое пятно с металлической хромированной структурой, с хрустальными декорами.

HU · Krómozott fém szerkezetű merev beépített spot, kristály díszítéssel.

BG · Фиксиран вграден спот с хромирана метална структура, с кристални украси.

SK · Pevný vstavaný reflektor s chrómovanou kovovou konštrukciou s krištáľovou dekoráciou.

ST 205 LED



art. **70357** WH White

Recessed SMD LEDs 5730 downlight, aluminium structure electrostatically painted in white, with sanded glass frame and polycarbonate diffuser. Driver included.

RO · Spot de încastrat cu LED-uri SMD 5730, structură din aluminiu vopsită în câmp electrostatic culoare albă, cu ramă din sticlă sablată și dispersor din policarbonat. Complet echipat cu alimentator.

IT · Incasso fisso a LED SMD 5730, struttura in alluminio verniciato a polveri bianco, con cornice in vetro sabbiato e diffusore in policarbonato. Dotato di driver.

RU · Встраиваемое световое пятно со светодиодами SMD 5730, алюминиевая конструкция, окрашенная в электростатическом поле, белого цвета, с веслом из пескоструйно-обработанного стекла, и диффузор из поликарбоната. Полностью оснащено фидером.

HU · Beépíthető ledes SMD 5730-as spotlámpa, elektrosztatikus térben fehérre festett alumínium szerkezettel, homokfúvott üveg kerettel és polikarbonát diszperzórral. Táppal ellátott szerkezet.

BG · Спот за вграждане с SMD 5730 LED-ове, алуминиева структура, боядисана в бяло електростатично поле, с рамка от гравирано стъкло и разсейвател от поликарбонат. Комплект оборудван със захранващо устройство.

SK · Zapustený SMD LED reflektor 5730, hliníková konštrukcia elektrostaticky maľovaná v bielej farbe, pieskované sklo s rámom a tienidlom z polykarbonátu. Súčasťou je napájac.

SMD LED · 5W · 4000K · CRI 80
LED flux 508 lm
Luminaire flux 320 lm



Ø75 mm

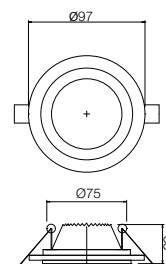

ST 206 LED



art. 70358 WH White

Recessed SMD LEDs 5730 downlight, aluminium structure electrostatically painted in white, with sanded glass frame and polycarbonate diffuser. Driver included.

RO · Spot de încastrat cu LED-uri SMD 5730, structură din aluminiu vopsită în câmp electrostatic culoare albă, cu ramă din sticlă sablată și dispersor din policarbonat. Complet echipat cu alimentator.

IT · Incasso fisso a LED SMD 5730, struttura in alluminio verniciato a polveri bianco, con cornice in vetro sabbiato e diffusore in policarbonato. Dotato di driver.

RU · Встраиваемое световое пятно со светодиодами SMD 5730, алюминиевая конструкция, окрашенная в электростатическом поле, белого цвета, с веслом из пескоструйно-обработанного стекла, и диффузор из поликарбоната. Полностью оснащено фидером.

HU · Beépíthető ledes SMD 5730-as spotlámpa, elektrosztatikus térben fehérre festett alumínium szerkezettel, homokfúvott üveg kerettel és polikarbonát diszperzórral. Táppal ellátott szerkezet.

BG · Спот за вграждане с SMD 5730 LED-ове, алуминиева структура, боядисана в бяло електростатично поле, с рамка от гравирано стъкло и разсейвател от поликарбонат. Комплект оборудван със захранващо устройство.

SK · Zapustený SMD LED reflektor 5730, hliníková konštrukcia elektrostaticky maľovaná v bielej farbe, pieskované sklo s rámom a tienidlom z polykarbonátu. Súčasťou je napájac.

SMD LED · 5W · 4000K · CRI 80
LED flux 508 lm
Luminaire flux 320 lm



Ø75 mm

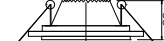
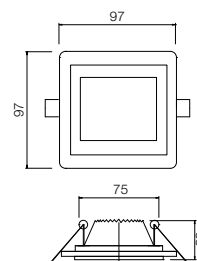

MT 137 LED



art. **70353** MWH Mat White
art. **70354** CH Chrome

SMD LED · 7W · 3000K · CRI 80
LED flux 724 lm
Luminaire flux 527 lm



art. **70349** MWH Mat White
art. **70350** CH Chrome

SMD LED · 7W · 4000K · CRI 80
LED flux 744 lm
Luminaire flux 560 lm



Ø75 mm

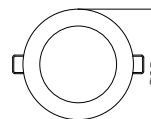
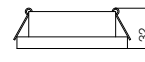

Recessed SMD LED downlight, protected against humidity, aluminium structure electrostatically painted in mat white or in chromed version, polystyrene diffuser. Equipped with driver.

RO · Spot de încadrat cu LED-uri SMD, cu grad de protecție la umiditate, structură din aluminiu vopsită în câmp electrostatic culoare albă sau versiune cromată, dispersor din polistiren. Complet echipat cu alimentator.

IT · Incasso fisso a LED SMD, con grado di protezione contro l'umidità, struttura in alluminio verniciato a polveri bianco oppure versione in cromo, diffusore in polistirolo. Dotato di driver.

RU · Встраиваемое световое пятно со светодиодами SMD, с защитой от влаги, алюминиевая конструкция, окрашенная в электростатическом поле белого цвета или в цветовом варианте исполнения, диффузор из полистирола. Полностью оснащено фидером.

HU · Merev beépített spot SMD LED-ekkel és fokozott nedvességvédelemmel ellátva, elektrosztatikus térben fehérre festett vagy krómozott alumínium szerkezettel, polisztirol diszperzórral. Táppal ellátott szerkezet.

BG · Спот за вграждане с LED-ове SMD, със степен на защита срещу влага, алуминиева структура, боядисана в бяло електростатично поле или хромиран вариант, разсейвател от полистирен. Оборудван с драйвер.

SK · Zapustený SMD LED reflektor, chránený proti vlhkosti, hliníková konštrukcia, elektrostaticky lakovaná v matne bielej farbe alebo v chrómovej farbe, polystyrénový difúzor. Súčasťou je napájač.



MT 138 LED



art. **70355** MWH Mat White
art. **70356** CH Chrome

SMD LED · 7W · 3000K · CRI 80
LED flux 724 lm
Luminaire flux 527 lm



art. **70351** MWH Mat White
art. **70352** CH Chrome

SMD LED · 7W · 4000K · CRI 80
LED flux 744 lm
Luminaire flux 560 lmm



Ø75 mm

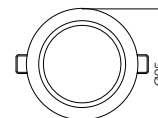
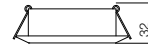

Recessed SMD LED downlight, protected against humidity, aluminium structure electrostatically painted in mat white or in chromed version, polystyrene diffuser. Equipped with driver.

RO · Spot de încastrat cu LED-uri SMD, cu grad de protecție la umiditate, structură din aluminiu vopsită în câmp electrostatic culoare albă sau versiune cromată, dispersor din polistiren. Complet echipat cu alimentator.

IT · Incasso fisso a LED SMD, con grado di protezione contro l'umidità, struttura in alluminio verniciato a polveri bianco oppure versione in cromo, diffusore in polistirolo. Dotato di driver.

RU · Встраиваемое световое пятно со светодиодами SMD, с защитой от влаги, алюминиевая конструкция, окрашенная в электростатическом поле белого цвета или в цветовом варианте исполнения, диффузор из полистирола. Полностью оснащено фидером.

HU · Merev beépített spot SMD LED-ekkel és fokozott nedvességvédelemmel ellátva, elektrosztatikus térben fehérre festett vagy krómozott alumínium szerkezettel, polisztirol diszperzórral. Táppal ellátott szerkezet.

BG · Спот за вграждане с LED-ове SMD, със степен на защита срещу влага, алуминиева структура, боядисана в бяло електростатично поле или хромиран вариант, разсейвател от полистирен. Оборудван с драйвер.

SK · Zapustený SMD LED reflektor, chránený proti vlhkosti, hliníková konštrukcia, elektrostaticky lakovaný v matne bielej farbe alebo v chrómovej farbe, polystyrénový difúzor. Súčasťou je napájač.

PT 07

WH White



CH Chrome

art. **70403** WH Bianco
art. **70404** CH Cromo

COB LED · 5W · 4000K · CRI 80
LED flux 380 lm
Luminaire flux 330 lm
Optic 45°

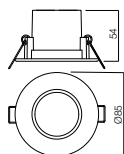

Recessed downlights equipped with SMD LED, mat white polycarbonate structure, frost polycarbonate diffuser, driver included.

RO · Spoturi echipate cu LED-uri SMD, pentru montaj încastrat, structură din policarbonat alb mat, dispersor din policarbonat satinat, alimentator inclus.

IT · Incassi fissi equipaggiati con LED SMD, struttura in policarbonato bianco opaco, diffusore in policarbonato satinato, driver incluso.

RU · Встраиваемые потолочные споты, оснащенные светодиодом SMD, матовая белая структура из поликарбоната, рассеиватель из сатинового поликарбоната, питатель входит в комплект.

HU · Beltéri besülyeszett spot lámpa ,SMD LED-el, matt fehér műanyag szerkezet, satén polikarbonát diszperzor, működtetőt tartalmaz.

BG · Спотове със SMD светодиоди, за вграден монтаж, структура от матов бял поликарбонат, дифузер от сатен поликарбонат, захранващото устройство е включено.

SK · Zápustné svietidlá vybavené LED SMD, matná biela polykarbonátová štruktúra, mrazuvzdorný polykarbonátový difúzor, vrátane vodiča.



ELC 1101



art. 70124 WH White

art. 70125 CH Chrome

GU10, 1 x max. 50W



Ø74 mm

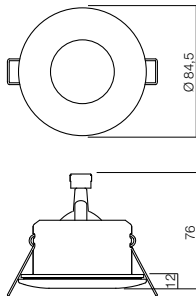

Fixed built-in downlight, zamak structure, glass diffuser, designed for use in bathrooms.

RO · Spot de încadrat fix cu structură din zamac, dispersor din sticlă, special pentru baie.

IT · Incasso fisso con struttura in fusione di zama, diffusore in vetro, per sale di bagno.

RU · Неподвижное встроенное световое пятно со структурой из медных сплавов, диффузор: стекло, специально для ванных помещений.

HU · Zamak szerkezetű merev beépített spot, üveg diszperzór, különösen a fürdőszoba számára.

BG · Фиксиран вграден спот със структура от замък, стъклен разпръсквач, специално за баня.

SK · Pevný vstavaný reflektor zo Zamak štruktúry, sklenený difúzor, špeciálne pre kúpeľne.

ELC 1104



art. 70126 WH White

art. 70127 CH Chrome

GU10, 1 x max. 50W



Ø74 mm

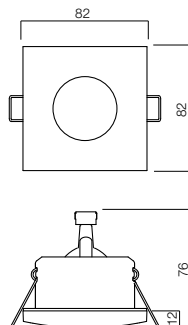

Fixed built-in downlight, zamak structure, glass diffuser, designed for use in bathrooms.

RO · Spot de încadrat fix cu structură din zamac, dispersor din sticlă, special pentru baie.

IT · Incasso fisso con struttura in fusione di zama, diffusore in vetro, per sale di bagno.

RU · Неподвижное встроенное световое пятно со структурой из медных сплавов, диффузор: стекло, специально для ванных помещений.

HU · Zamak szerkezetű merev beépített spot, üveg diszperzór, különösen a fürdőszoba számára.

BG · Фиксиран вграден спот със структура от замък, стъклен разпръсквач, специално за баня.

SK · Pevný vstavaný reflektor zo Zamak štruktúry, sklenený difúzor, špeciálne pre kúpeľne.



**OUT-
DOOR**

Embo



Light fittings for exterior equipped with SMD LEDs, housing of die cast aluminum electrostatically painted in dark grey, diffuser of opal polycarbonate.

RO - Corpuri pentru exterior echipate cu LED-uri SMD, corp din aluminiu turnat sub presiune vopsit în câmp electrostatic gri închis, dispersor din policarbonat opal.

IT - Apparecchi per esterni equipaggiati con LED SMD, corpo in pressofusione di alluminio verniciato a polveri colore grigio scuro, diffusore in policarbonato opalino.

RU - Наружные светильники, оснащенные светодиодами SMD LEDs, алюминиевый корпус, литый под давлением, с электростатической покраской в темно-серый цвет, опаловый поликарбонатный рассеиватель.

HU - Kültéri lámpa testek, SMD LED-el szerelve, nyomás alatt öntött alumínium szerkezet, elektrosztatikus mezőben festett sötét szürke színű, opál polkarbonát diszperzör.

BG - Тела за екстериор, разполагат със SMD светодиоди, тяло от лят под налягане алуминий, боядисано в електростатично поле в тъмно сиво, дифузер от опалов поликарбонат.

SK - Svietidlo do exteriéru vybavené SMD LED diódami, kryt z hlinikového tlakového odliatku elektrostaticky lakovaný v tmavo šedej farbe, difúzor z opálového polykarbonátu.



90279

INFO/DIMENSIONS

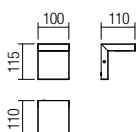

90279
SMD LED · 8W
3000K · CRI 80
LED flux 960 lm
Luminaire flux 655 lm

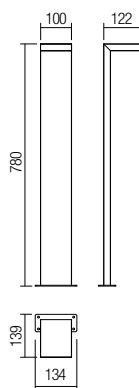

90280
SMD LED · 8W
3000K · CRI 80
LED flux 960 lm
Luminaire flux 655 lm





90280

Vince



Exterior wall lamps equipped with COB LEDs, direct/indirect light with "wall washer" lighting effect. Die cast aluminium housing electrostatically painted in dark grey/dark brown, transparent glass diffusers. Available in versions equipped with motion detector.

RO · Aplice pentru exterior echipate cu LED-uri COB, emisie luminoasă directă/indirectă cu efect de lumină "wall washer". Corp din aluminiu turnat sub presiune vopsit în câmp electrostatic culoare gri închis/maron închis, dispersoare din sticlă transparentă. Disponibile și în variante echipate cu senzor de prezență.

IT · Applique per esterni, equipaggiate con LED COB, ad emissione luminosa diretta/indiretta con effetto luce "wall washer". Corpo in pressofusione di alluminio, verniciato a polveri grigio scuro/marrone scuro, diffusori in vetro trasparente. Disponibile nelle versioni equipaggiate con sensore di movimento.

RU · Бра для наружного освещения, оснащенные светодиодами COB, с прямым/отраженным распределением света и эффектом «омывания стены». Корпус из литого под давлением алюминия, окрашенного в электростатическом поле в темно-серый/темно-коричневый цвет, рассеиватель из прозрачного стекла. Доступны в комплектации с датчиком движения.

HU · Kültéri falikarok, COB LED-el szerelve, "wall washer" fényhatású direkt/indirekt szórással, elektrosztatikus mezőben sötétszürkére festett, nyomás alatt öntött alumínium szerkezet.

BG · Външни стени осветителни тела, оборудвани с COB LED, директна/индиректна светлина с ефект на осветление "обливане на стена". Алуминиев корпус с электростатично боядисване в тъмно сиви/тъмнокафяви, прозрачни стъклени дифузори. Предлага се във версии, оборудвани с детектор за движение.

SK · Exteriérové nástenné svietidlá, vybavené LED COB diódami s priamym/nepriamym osvetlením s efektom osvetlenia v stene. Hliniková konštrukcia lakovaná v tmavošedej/tmavohnedej farbe, priehľadné sklenené difúzory. K dispozícii vo verziách so senzorom pohybu.



9452



9455



INFO/DIMENSIONS

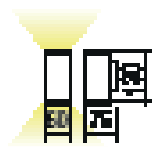

● 9452 Dark grey

● 9454 Dark Brown

COB LED · 2 x 3W · 3000K · CRI 80

Optic 40°/40°

LED flux 634 lm

Luminaire flux 505 lm

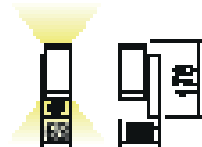

● 9453 Dark grey + Motion detector

● 9455 Dark Brown + Motion detector

COB LED · 2 x 3W · 3000K · CRI 80

Optic 40°/40°

LED flux 634 lm

Luminaire flux 505 lm





9454

Wink



Wall lamps for exterior equipped with LEDs, direct/indirect light distribution and adjustable angle. Die cast aluminium housing electrostatically painted in dark grey, transparent glass diffusers. Version fitted with RGB + CW LEDs and TUYA control system.

RO · Aplice pentru exterior echipate cu LED-uri, dispersie luminoasă directă/indirectă cu unghi reglabil. Corp din aluminiu turnat sub presiune vopsit în câmp electrostatic gri închis, dispersoare din sticlă transparentă. Versiune dotată cu LED-uri RGB + CW și sistem de control TUYA.

IT · Applique per esterni equipaggiate con LED ad emissione luminosa diretta/indiretta con fasci di luce regolabile. Corpo in pressofusione di alluminio, verniciato a polveri grigio scuro, diffusori in vetro trasparente. Versione dotata di LED RGB + CW e sistema di controllo TUYA.

RU · Настенные светильники для наружного освещения, оснащенные светодиодами, с прямым / отраженным распределением света и регулируемым углом наклона. Корпус из литого алюминия, окрашенный в электростатическом поле в темно-серый цвет, диффузоры из прозрачного стекла. Версия оснащена RGB + холодного белого цвета и системой управления TUYA.

HU · Kültéri fali lámpa, állítható szögű direkt/indirekt fényezésű LED-el szerelve. Magasnyomás alatt öntött alumínium szerkezet, elektrosztatikus mezőben festett sötét szürke színű, áttetsző üveg diszperzör. RGB + hideg fehér LED-ekkel és TUYA vezérlőrendszerrel felszerelt változat.

BG · Аплици за екстериор, разполагат със светодиоди, директно/индиректно разсейване на светлината с регулируем ъгъл. Тяло от лят под налягане алуминий, боядисано в тъмно сиво електростатично поле, прозрачни стъклени дифузери. Версията разполага със RGB + студени бели светодиоди и система за управление TUYA.

SK · Nástenné exteriérové svietidlá vybavené LED diódami, priamym / nepriamym rozložením svetla a nastaviteľným uhlom. Teleso liateho hliníka elektrostaticky lakované v tmavosivej farbe s priehľadným skleneným difúzorom. V erzia vybavená RGB + studenými bielymi LED diódami a riadiacim systémom TUYA.



INFO/DIMENSIONS

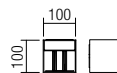

90291

COB LED · 10W

3000K · CRI 80

LED flux 760 lm

Luminaire flux 480 lm



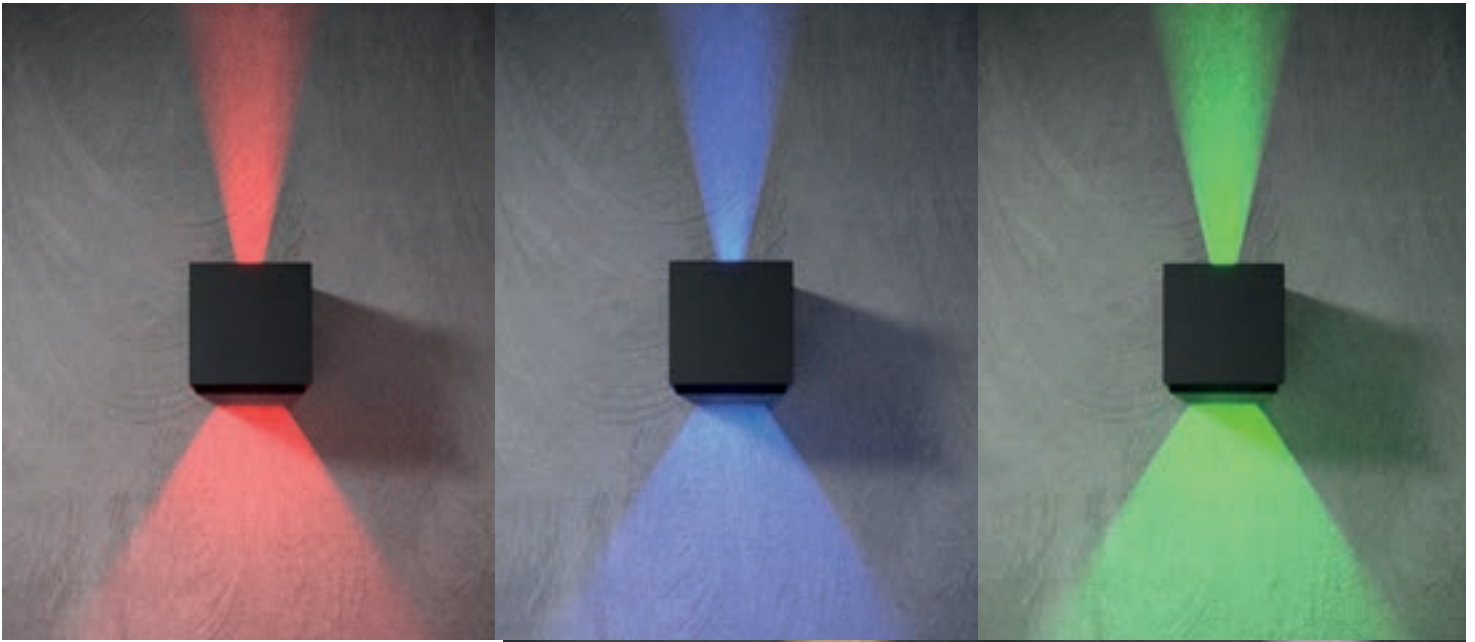

**Wi-Fi CONNECTION
APP CONTROL**



Available on



Works with

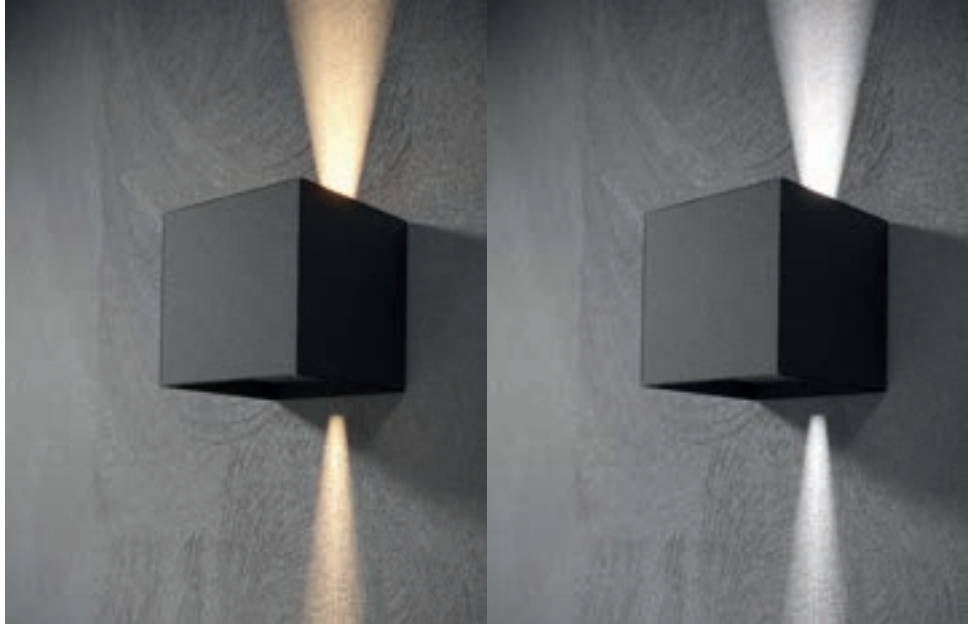

INFO/DIMENSIONS

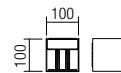

90293
 COB LED · 6W
 2700-6500K + RGB · CRI 80
 LED flux 520 lm
 Luminaire flux 290 lm



Asti LED



Wall lamps for exterior equipped with SMD LEDs, die cast aluminium housing electrostatically painted in sand white, dark grey or dark brown, opal polycarbonate diffuser.

RO · Serie de aplicе pentru exterior echipate cu LED-uri SMD, corp din aluminiu turnat sub presiune vopsit în câmp electrostatic alb mat, gri închis sau maro închis, dispersor din policarbonat opal.

IT · Applique per esterni equipaggiate con LED SMD, corpo in pressofusione di alluminio verniciato a polveri bianco opaco, grigio scuro o marrone scuro, diffusore in policarbonato opalino.

RU · Серия бра для наружного освещения, оснащенные светодиодами SMD, литой алюминиевый корпус, окрашен в электростатическом поле в матовый белый, темно-серый или темно-коричневый цвет, рассеиватель из опалового поликарбоната.

HU · Kültéri fali lámpák, SMD LED-el szerelve, elektrosztatikus mezőben festett matt fehér, sötét szürke vagy sötét barna nyomás alatt öntött alumínium szerkezet, opál polikarbonát diszperzór.

BG · Серия стенини осветления за екстериор, оборудвани със SMD светодиоди, корпус от лят под налягане алуминий, боядисан в матово бяло, тъмно сиво или тъмнокафяво в электростатично поле, дифузер от опалов поликарбонат.

SK · Nástenné exteriérové svietidlá vybavené LED diódami SMD, hliníková konštrukcia lakovaná v pieskovo-bielej, tmavošedej alebo tmavohnedej, opálový polykarbonátový difúzor.



90184



90188



90189

INFO/DIMENSIONS

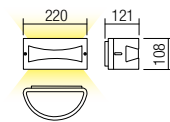
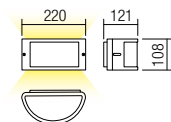

- 90184 Sand White
- 90185 Dark Grey
- 90186 Dark Brown

SMD LED · 10W · 3000K · CRI 80

LED flux 1100 lm

Luminaire flux 655 lm



- 90187 Sand White
- 90188 Dark Grey
- 90189 Dark Brown

SMD LED · 10W · 3000K · CRI 80

LED flux 1100 lm

Luminaire flux 610 lm



Scudo



Wall lamps for exterior equipped with SMD LEDs, die cast aluminium housing electrostatically painted in sand white, dark grey or dark brown, opal polycarbonate diffuser.

RO · Aplice pentru exterior echipate cu LED-uri SMD, corp din aluminiu turnat sub presiune vopsit în câmp electrostatic alb mat, gri închis sau maro închis, dispersor din policarbonat opal.

IT · Applique per esterni equipaggiate con LED SMD, corpo in pressofusione di alluminio verniciato a polveri bianco opaco, grigio scuro o marrone scuro, diffusore in policarbonato opalino.

RU · Настенные светильники для наружного освещения, оснащенные светодиодами SMD, литой алюминиевый корпус, окрашен в электростатическом поле в матовый белый, темно-серый или темно-коричневый цвет, рассеиватель из опалового поликарбоната.

HU · Kültéri fal lámpák, SMD LED-el szerelve, elektrosztatikus mezőben festett matt fehér, sötét szürke vagy sötét barna nyomás alatt öntött alumínium szerkezet, opál polikarbonát diszperzór.

BG · Осветелителни тела за екстериор, оборудвани с SMD светодиоди, корпус от лят под налягане алуминий, боядисан в цвят матово бяло, тъмносиво или тъмнокафяво в електростатично поле, дифузер от опалов поликарбонат.

SK · Nástené exteriérové svietidlá vybavené LED diódami SMD, hliníková konštrukcia lakoavná v pieskovo-bielej, tmavošedej alebo tmavohnedej, opálový polykarbonátový difúzor.



90192



90191



90190

INFO/DIMENSIONS

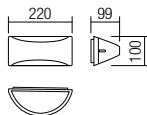

○ 90190 Sand White

● 90191 Dark Grey

● 90192 Dark Brown

SMD LED · 10W · 3000K · CRI 80

LED flux 1100 lm

Luminaire flux 542 lm



Tortilla



Ceiling lamp for exterior equipped with warm white and cool white SMD LEDs, fitted TUYA control system. Housing of polycarbonate and ABS white alloy, anti-UV opal polycarbonate diffuser. TUYA system regulates the following functions: ON/OFF, adjustment of light intensity from 10 to 100%, selection of the color temperature from warm white to cool white, programming of the start/stop time.

RO - Plafonieră pentru exterior echipată cu LED-uri SMD alb cald și alb rece, dotată cu sistem de control TUYA. Corp din aliaj de policarbonat și ABS alb, dispersor din policarbonat opal anti UV. Prin sistemul de control TUYA se pot seta următoarele funcții: ON/OFF, reglarea intensității luminoase între 10-100%, setarea temperaturii de culoare a luminii de la alb cald la alb rece, programarea timpului de pornire/oprire.

IT - Plafoniera per interni equipaggiata con LED SMD bianco caldo e bianco freddo, dotata di sistema di controllo TUYA. Corpo in lega di policarbonato e ABS bianco, diffusore anti UV in policarbonato opale. Tramite il sistema di controllo TUYA si possono personalizzare molteplici funzioni: ON/OFF, regolazione dell'intensità della luce da 10 a 100%, variazione della temperatura del colore da bianco caldo a bianco freddo e programmazione del tempo di funzionamento compreso di accensione/spegnimento.

RU - Потолочный светильник для наружного освещения, оснащенный светодиодами SMD теплого и холодного белого цветов, оснащен системой управления TUYA. Корпус из сплава поликарбоната и белого ABS, рассеиватель из опалового поликарбоната с защитой от УФ-излучения. Система TUYA регулирует следующие функции: ВКЛ/ВЫКЛ, регулировка интенсивности света от 10 до 100%, выбор цветовой температуры от теплого белого до холодного белого, программирование времени вкл/выкл.

HU - Kültéri mennyezeti lámpa, hideg vagy meleg színű SMD LED-el szerelve, TUYA vezérlő rendszerrel, polikarbonát ABS ötvözetű lámpatest, sárgaréz, UV-álló, áttetsző polikarbonát diszperzör. A TUYA rendszernek a következők funkciói vannak: KI/BE, fényerőszabályozás 0-100%, hidegről meleg fehér fényre való váltás, be/ki kapcsolat programálása.

BG - Таванна външна лампа, оборудвана с топло бели и студено бели SMD светодиоди, вградена система за управление TUYA Корпус от поликарбонат и ABS бяла сплав, анти-UV опалов дифузор от поликарбонат. Системата TUYA регулира следните функции: ВКЛ/ ИЗКЛ, настройка на интензитета на светлината от 10 до 100%, избор на цветна температура от топло бяло до студено бяло, програмиране на времето за стартиране/спиране.

SK - Vonkajšie stropné svetidlo vybavené teplými a studenými bielymi SMD LED diódami, vybavené riadiacim systémom TUYA. Teleso z polykarbonátu a bielej zliatiny ABS, polykarbonátový difúzor anti-UV opál. Systém TUYA reguluje nasledujúce funkcie: ON/OFF, nastavenie intenzity svetla od 10 do 100%, výber teploty farby od teplej bielej po studenú bielu, programovanie času štart/stop.

Wi-Fi CONNECTION APP CONTROL



Available on



Works with



INFO/DIMENSIONS

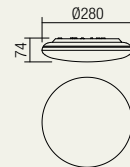

90208

SMD LED · 25W
3000-6500K · CRI 80
LED flux 2400 lm
Luminaire flux 2098 lm

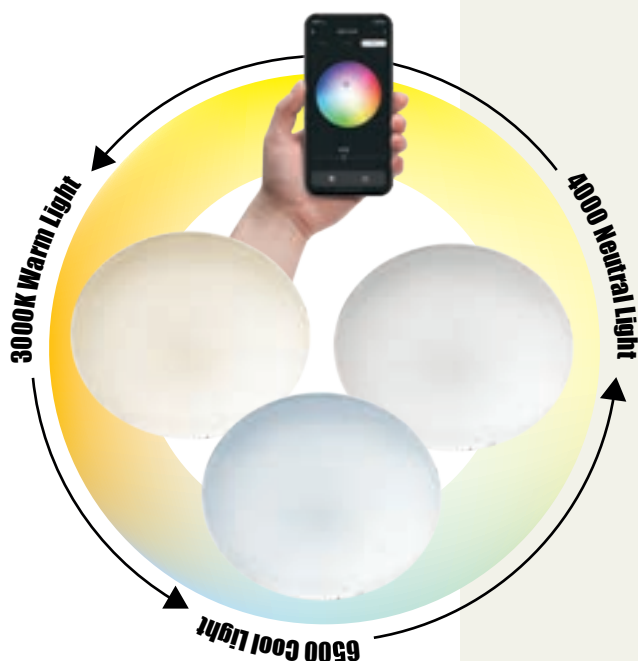



90208

Midas

Outdoor light fixtures, die cast aluminium body electrostatically painted in mat black, transparent glass diffusers.



90283

RO · Corpuri de iluminat pentru exterior, structură din aluminiu turnat sub presiune vopsit în câmp electrostatic negru mat, dispersoare din sticlă transparentă.

IT · Apparecchi per esterni, corpo in pressofusione di alluminio verniciato a polveri colore nero opaco, diffusori in vetro trasparente.

RU · Наружные светильники, структура из алюминия, литого под давлением, с электростатической покраской в матовый черный цвет, прозрачные стеклянные рассеиватели.

HU · Kültéri lámpa testek, SMD LED-el szerelve, nyomás alatt öntött alumínium szerkezet, elektrosztatikus mezőben festett matt fekete színű, áttetsző üveg diszperzór.

BG · Тела за екстериор, структура от лят под налягане алуминий, боядисана в електростатично поле в матово черно, дифузери от прозрачно стъкло.

SK · Exteriérové svietidlá, telo z hliníkového tlakového odliatku, elektrostaticky lakované matne čiernou, priehľadným skleneným difúzorom.

INFO/DIMENSIONS



90281

E27, 1 x max. 42W

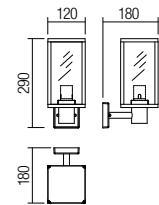

90282

E27, 1 x max. 42W

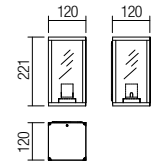

90283

E27, 1 x max. 42W

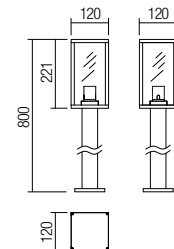



90281



90282



Outdoor wall lamps, die cast aluminum body electrostatically painted, available in dark grey or rust patina, glass diffusers. "Wall washer" light effect.

RO · Serie de aplicе pentru exterior, corp din aluminiu turnat sub presiune vopsit în câmp electrostatic, disponibile în variante de culori gri închis sau în finisaj rugină, dispersoare din sticlă. Efect de lumină "wall washer".

IT · Serie di applique per esterni, corpo in pressofusione di alluminio verniciato a polveri, disponibili in colore grigio scuro o finitura ruggine, diffusori in vetro. Effetto luce "wall washer".

RU · Серия бра для внешнего освещения, тело из алюминия, литого под давлением и окрашенного в тёмно-серый цвет или с отделочным слоем ржавого цвета, стеклянные диффузоры. Эффект «струящего» по стенам света.

HU · Kültéri faliámpasorozat, nyomás alatt öntött alumíniumtest, elektrosztatikus mezőben festve, kapható sötétszürke vagy rozsdás fényezésű színekben, üveg diszperzörökkel. „Wall washer” fényhatás.

BG · Серия външни лампи за стена, алуминево тяло, отливан под налягане, боядисани в електростатично поле на разположение във варианти на цветовете тъмно сив или покритие ръжда, стъклени разпръсквачи. Светлинен ефект „wall washer”.

SK · Vonkajšie nástenné svietidlá, hliníkový odliatok, k dispozícii v rôznych farbách - tmavo šedá alebo hrzavá patina, sklenené difúzory so svetelným efektom.



9359



9359

9330

INFO/DIMENSIONS

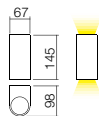

● 9352 Dark Grey
● 9359 Rust

GU10, 2 x max. 35W

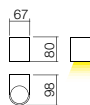

● 9330 Dark Grey
● 9358 Rust

GU10, 1 x max. 35W



Focus



Outdoor lighting fixtures, die cast aluminum body painted in mat black, transparent polycarbonate diffusers.

RO · Aparate de iluminat pentru exterior, corp din aluminiu turnat sub presiune culoare negru mat cu dispersoare din policarbonat transparent.

IT · Apparecchi d'illuminazione per esterni, corpo in pressofusione di alluminio colore nero opaco con diffusori in policarbonato trasparente.

RU · Осветительное оборудование для внешнего освещения, тело из алюминия, литого под давлением, матового чёрного цвета, диффузоры из прозрачного поликарбоната.

HU · Kültéri világítóberendezések, mat fekete színű, nyomás alatt öntött alumíniumból, áttetsző polikarbonát diszperzórral.

BG · Външни осветителни устройства, алуминево тяло, отливо под налягане, цвят матов черен, с разпръсквачи от прозрачен поликарбонат.

SK · Vonkajšie osvetlenie, hliníkový odliatok, matná čierna, difúzory vyrobené z priehľadného polykarbonátu.



9812



9810

9811



INFO/DIMENSIONS

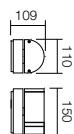

9811

GU10, 1 x max. 28W

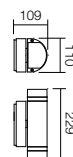

9810

GU10, 2 x max. 28W

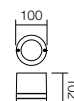

9812

GU10, 1 x max. 28W





Ceilings lamp for exterior, aluminium structure electrostatically painted in mat white or dark grey, transparent glass diffusers. GU10 bulbs not included.

RO · Plafoniere pentru exterior, structură din aluminiu vopsit în câmp electrostatic alb mat sau gri închis, dispersoare din sticlă transparentă. Becurile GU10 nu sunt incluse.

IT · Plafoniere per esterni, struttura in alluminio verniciato a polveri bianco opaco o grigio scuro, diffusori in vetro trasparente. Lampadine GU10 non incluse.

RU · Потолочный светильник для наружного освещения, корпус из алюминия окрашен в электростатическом поле в темно-серый цвет, рассеиватели из прозрачного стекла. Лампы GU10 не включены в комплект.

HU · Kültéri mennyezeti lámpák, elektrosztatikus mezőben matt fehérre vagy sötét szürkére festett alumínium szerkezet, áttetsző üveg diszperzáló. GU10 izzó nem tartozék.

BG · Таванни осветления за екстериор, структура от алуминий боядисана в электростатично поле в цвят матово бяло или тъмно сиво, дифузери от прозрачно стъкло. Крушките GU10 не са включени.

SK · Stropné lampy pre exteriér, hliníková konštrukcia elektrostaticky lakovaná matnou bielou alebo tmavošedou farbou s priehľadnými sklenenými difúzormi. Žiarovky GU10 nie sú súčasťou balenia.



90182



90179

INFO/DIMENSIONS

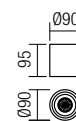

○ 90179 Sand White

● 90180 Dark Grey

GU10, 1 x max. 35W



○ 90181 Sand White

● 90182 Dark Grey

GU10, 1 x max. 35W





Marano



Outdoor wall lamp, die cast aluminum body electrostatically painted in mat black, smoky polycarbonate diffuser.

RO - Aplice pentru exterior, corp din aluminiu turnat sub presiune vopsit în câmp electrostatic culoare negru mat, dispersor din policarbonat fumuriu.

IT - Applique per esterni, corpo in pressofusione di alluminio verniciato a polveri in colore nero opaco, diffusore in policarbonato fumè.

RU - Бра для внешнего освещения, тело из алюминия литого под давлением и крашеного в электростатическом поле, матового чёрного цвета, диффузоры из дымчатого поликарбоната.

HU - Kültéri falilámpa, nyomás alatt öntött alumínium test, elektrosztatikus mezőben festve, mat fekete színű, füstös polikarbonát diszperzóra.

BG - Външни лампи, алуминиево тяло, отливано под налягане, боядисано в электростатично поле, цвят матов черен, разпръсквач от опушен поликарбонат.

SK - Vonkajšie nástenné svietidlo, hliníkový odliatok, elektrosztatické farbenie - matná čierna, dymový polykarbonátový difúzor.



9397



9397



9820

INFO/DIMENSIONS

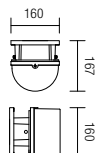

9820

E27, 1 x max. 42W



9397

E27, 1 x max. 70W



Bonn



Series of outdoor luminaires, die cast aluminium body available in several finishing variants: mat black with smoky polycarbonate diffuser or dark grey with satin polycarbonate diffuser.

RO - Serie de aparate de iluminat pentru exterior, corp din aluminiu turnat sub presiune, disponibile în variante de finisaje: negru mat cu dispersor din policarbonat fumuriu sau gri închis cu dispersor din policarbonat satinat.

IT - Serie di apparecchi d'illuminazione per esterni, corpo in pressofusione di alluminio, disponibili nelle varianti di finitura: nero opaco con diffusore in policarbonato fumè oppure grigio scuro con diffusore in policarbonato satinato.

RU - Серия светильников для наружного освещения, алюминиевый корпус, литый под давлением, в варианте исполнения отделки: чёрного матового цвета, диффузор из дымчатого или тёмного серого цвета, диффузор из сатирированного поликарбоната.

HU - Kültéri világítótестek sorozata, nyomás alatt öntött alumínium test, fényvezései lehetőségek: mat fekete füstös polikarbonát diszperzórral vagy sötétszürke szaténos polikarbonát diszperzórral.

BG - Серия екстериорни осветителни тела, тяло от алуминий, лят под налягане, налични във варианти с покритие: матово черно с разсейвател от опушен поликарбонат или тъмно сиво с разсейвател от сатениран поликарбонат.

SK - Rad vonkajších svietidiel, hliníkový odliatok, k dispozícii vo variantách: matná čierna s difúzorom z dymového polykarbonátu alebo tmavo šedá so saténovým-polykarbonátovým difúzorom.



9210

9818

INFO/DIMENSIONS

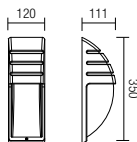

- 9818 Mat Black
- 9210 Dark grey

E27, 1 x max. 42W



Cage



Series of wall lamps for exterior, body of polycarbonate and ABS alloy finished in brass, copper or black, anti-UV transparent polycarbonate diffuser.

RO · Serie de aplicie pentru exterior, corp din aliaj de policarbonat cu ABS finisat alamă, cupru sau negru, dispersor din policarbonat transparent anti UV.

IT · Serie di applique per esterni, corpo in lega di policarbonato e ABS, finitura ottone, rame o nera, diffusore in policarbonato trasparente anti UV.

RU · Серия бра для наружного освещения, корпус из сплава поликарбоната и ABS с отделкой из латуни, меди или черного цвета, рассеиватель из прозрачного поликарбоната с защитой от УФ-излучения.

HU · Kültéri fali lámpák, polikarbonát ABS ötvözetű lámpatest, sárgaréz, réz, fekete színben, UV-álló, áttetsző polikarbonát diszperzór.

BG · Серия външни стенини осветителни тела, корпус от поликарбонатна сплав с ABS с месингово, медно или черно покритие, прозрачен анти-UV дифузор от поликарбонат.

SK · Sériá nástenných svietidiel do exteriéru, telo z polykarbonátu a zlatiny ABS povrchovo upravené v mosadznej, mednej alebo čiernej farbe, anti-UV priehľadný polykarbonátový difúzor.



90205



90206



90207

INFO/DIMENSIONS

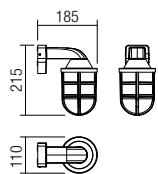

- 90205 Brass
- 90206 Copper
- 90207 Black

E27, 1 x max. 28W





90205

Triton

Series of light fixtures for exterior, body of polycarbonate and ABS alloy finished in brass, copper or black, anti-UV opal polycarbonate diffuser.

RO · Serie de corpuri de iluminat pentru exterior, corp din aliaj de policarbonat cu ABS finisat alamă, cupru sau negru, dispersor din policarbonat opal anti UV.

IT · Serie di apparecchi per esterni, corpo in lega di policarbonato e ABS, finitura ottone, rame o nero, diffusore in policarbonato opale anti UV.

RU · Серия светильников для наружного освещения, корпус из сплава поликарбоната и ABS с отделкой из латуни, меди или черного цвета, опаловый рассеиватель из поликарбоната с защитой от УФ-излучения.

HU · Kültéri lámpa testek, polikarbonát ABS ötvözetű lámpatest, sárgaréz, réz, fekete színben, UV-álló, opál polikarbonát diszperzór.

BG · Серия осветителни тела за външно осветление, корпус от поликарбонатна сплав с ABS с месингово, медно или черно покритие, анти-UV опалов дифузор от поликарбонат.

SK · Sériá svietidiel pre exteriér, telo z polykarbonátu a zliatiny ABS s povrchovou úpravou z mosadze, medi alebo čiernej farby, difúzora z opálového polykarbonátu anti-UV.



90193



90194



90195

INFO/DIMENSIONS

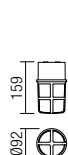

- 90193 Brass
- 90194 Copper
- 90195 Black

E27, 1 x max. 28W

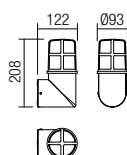

- 90196 Brass
- 90197 Copper
- 90198 Black

E27, 1 x max. 28W

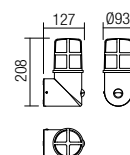

- 90199 Brass + Motion detector sensor
- 90200 Copper + Motion detector sensor
- 90201 Black + Motion detector sensor

E27, 1 x max. 28W

+ Movement detector sensor





90200



90196

90197

90198



90201



90203



90202



90204



INFO/DIMENSIONS

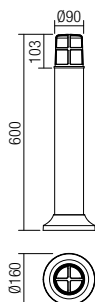
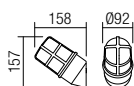

- 90202 Brass
- 90203 Copper
- 90204 Black

E27, 1 x max. 28W



90246 Black

E27, 1 x max. 28W





90204

Vortex

Outdoor wall lamp, die cast aluminium body electrostatically painted in dark brown, opal polycarbonate diffuser.



RO - Aplică pentru exterior, corp din aluminiu turnat sub presiune vopsit în câmp electrostatic maron închis și dispersor din policarbonat opal.

IT - Applique per esterni, corpo in pressofusione di alluminio, verniciato a polveri marrone e diffusore in policarbonato opalino.

RU - Бра для наружного освещения, корпус из литого под давлением алюминия, окрашенного в электростатическом поле в темно-коричневый цвет, рассеиватель из опалового поликарбоната.

HU - Kültéri falikarok, elektrosztatikus mezőben sötétbarnára festett, nyomás alatt öntött alumínium szerkezet, opál polikarbonát diszperzór.

BG - Външна стенна лампа, алуминиев корпус от електроизолационен материал, боядисан в тъмно кафяв, оптичен поликарбонатен дифузор.

SK - Exteriérové nástenné svietidlo, hliníková konštrukcia lakovaná v tmavohnedej farbe, opálový polykarbonátový difúzor.

INFO/DIMENSIONS

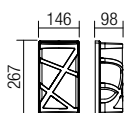

9097

E27, 1 x max. 42W



Dalma



Wall lamp for outdoor, opal polycarbonate body, frontal part of fretted metal finished mat black with gold patina.

RO · Aplică pentru exterior, corp din policarbonat opal cu parte frontală din metal traforat finisaj negru cu patină aurie.

IT · Applique da esterni, corpo in policarbonato bianco opale, frontale in metallo con decoro traforato, finitura nero patinato oro.

RU · Бра для наружного освещения, опаловый корпус из поликарбоната, фронтальная часть из матового металла с отделкой белого цвета и золотой патиной.

HU · Beltéri falikar opál polikarbonát szerkezet, oldalt perforált fekete antik arany fémrészekkel.

BG · Екстериорен аплик, тяло от опалов поликарбонат, предна част от метално черно матово покритие със златна патина.

SK · Nástenná exteriérová lampa, opálové polykarbonátové teleso, čelná časť z plechu v matnej čiernej so zlatou patinou.



9014

INFO/DIMENSIONS

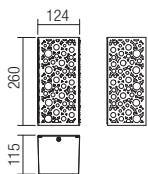

● 9014 Black/Gold

E27, 1 x max. 42W



Sfera



Outdoor series of lamps, black polycarbonate body with spheric diffuser of opal acryl or smoky variant. The poles are made out of zinc-coated steel, PVC coated, UV and corrosion resistant.

RO · Serie de lămpi pentru exterior, corp din policarbonat negru cu dispersor sferic din acril opal sau variantă fumuriu. Stâlpii sunt din oțel zincat îmbrăcat în PVC, rezistent la razele UV și coroziune.

IT · Serie di lampade per esterni, corpo in policarbonato nero, diffusore sferico in acrilico opalino o nella variante fumè. Pali con anima interna in acciaio zincato e rivestimento esterno alettato in PVC, resistente ai raggi UV e alla corrosione.

RU · Серия бра для внешнего освещения, тело из чёрного поликарбоната со сферическим диффузором из акрила цвета опала или дымчатого цвета. Столбы сделаны из оцинкованной стали, по-крытой в ПВХ и устойчивой к ультрафиолетовому излучению и коррозии.

HU · Kültéri lámpasorozat, fekete polikarbonát test, opálás vagy füstös akril gömbszerű diszperzórral. Az oszlopok cinkelt acélból készültek, mely PVC-vel van bevonva, ellenáll az UV sugaraknak és a korróziónak.

BG · Серия лампи за стена, тяло от черен поликарбонат със сферичен разпръсквач от опален акрил или опушен вариант. Стълбовете са от подцинкована стомана, облечена в PVC, устойчив на UV лъчи и корозия.

SK · Vonkajšia séria svietidiel, čierny polykarbonát s guľovým difúzorom z opalového akrylu alebo dymová varianta. Tyče sú vyrobené z pozinkovanej ocele, potiahnuté PVC, odolné voči UV žiareniu a korózií.



Ø20cm

Ø25cm







Ø20cm

INFO/DIMENSIONS

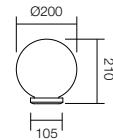
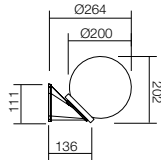
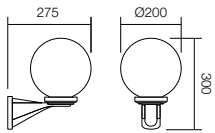

● 9788 Smoky
○ 9787 Opal

E27, 1 x max. 28W



● 9866 Smoky
○ 9867 Opal

E27, 1 x max. 28W



● 9760 Smoky
○ 9761 Opal

E27, 1 x max. 28W



Ø25cm

INFO/DIMENSIONS

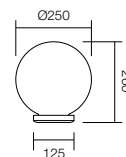
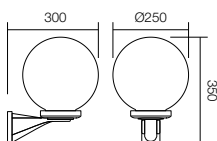
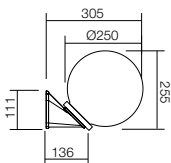

● 9872 Smoky
○ 9873 Opal

E27, 1 x max. 42W



● 9790 Smoky
○ 9789 Opal

E27, 1 x max. 42W



● 9770 Smoky
○ 9771 Opal

E27, 1 x max. 42W



Ø20cm

INFO/DIMENSIONS

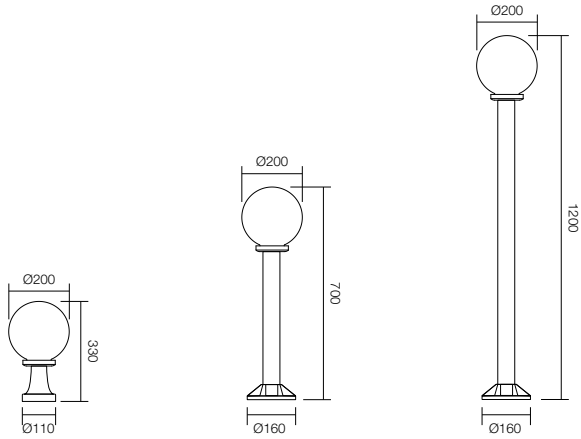

● **9764 Smoky**
○ **9765 Opal**
E27, 1 x max. 28W



● **9768 Smoky**
○ **9769 Opal**
E27, 1 x max. 28W



● **9766 Smoky**
○ **9767 Opal**
E27, 1 x max. 28W



Ø25cm

INFO/DIMENSIONS

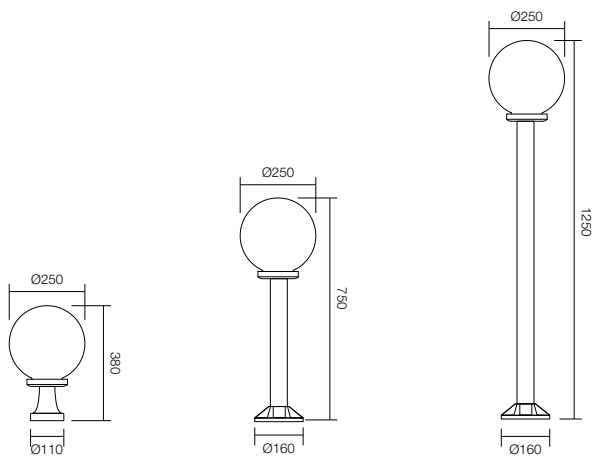

● **9774 Smoky**
○ **9775 Opal**
E27, 1 x max. 42W



● **9779 Smoky**
○ **9780 Opal**
E27, 1 x max. 42W



● **9776 Smoky**
○ **9777 Opal**
E27, 1 x max. 42W





Wall lamp for exterior, housing of opal polycarbonate with the front in stainless steel electrostatically painted in dark grey.

RO · Aplică pentru exterior, corp din policarbonat opal cu parte frontală din inox vopsit în câmp electrostatic culoare gri închis.

IT · Applique da esterni, corpo in policarbonato bianco opale con frontale in acciaio inox verniciato a polveri grigio scuro.

RU · Бра для наружного освещения, корпус из опалового поликарбоната, с передней частью из нержавеющей окрашенной в электростатическом поле в темно серый цвет.

HU · Kültéri fali lámpa, opál polikarbonát szerkezettel, elektrosztatikus mezőben festett sötét szürke inox első résszel.

BG · Екстериорен аплик, тяло от поликарбонат опал с предна част от инокс, електростатично боядисан в тъмно сиво.

SK · Nástenné exteriérové svietidlo s polykarbonátom a nehrdzavejúcej ocele v tmavošedej farbe.



9001



9001

INFO/DIMENSIONS

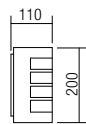

9001

E27, 1 x max. 11W





Outdoor wall lamp, opal polycarbonate body with steel front part.

RO · Aplică pentru exterior, corp din policarbonat opal cu parte frontală din inox.

IT · Applique da esterni, corpo in policarbonato bianco opale con frontale in acciaio inox.

RU · Бра для внешнего освещения, тело из поликарбоната с передней частью из нержавеющей стали.

HU · Kültéri falilámpa, polikarbonát test, előlap inoxid.

BG · Външна лампа за стена, тяло от поликарбонат с предна част от неръждаема стомана.

SK · Vonkajšie nástenné svietidlo, opálový polykarbonát s ocelovou prednou časťou.



9357

INFO/DIMENSIONS

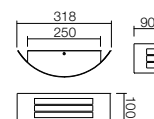
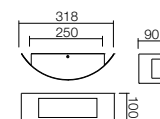

9356

E27, 1 x max. 15W



9357

E27, 1 x max. 15W



9356



9357

Colonna



Outdoor lighting fixtures, made out of steel with opal white polycarbonate diffuser.

RO · Corpuri de iluminat pentru exterior, din inox cu dispersor din policarbonat alb opal.

IT · Apparecchi d'illuminazione per esterni, corpo in acciaio inox con diffusore in policarbonato bianco opale.

RU · Осветительные тела для внешнего освещения, из нержавеющей стали, диффузор из поликарбоната белого цвета опала.

HU · Kültéri inox világítótestek, fehér opálos polikarbonát diszperzórral.

BG · Външни осветителни тела, от неръждаема стомана с разпръсквач от бяло-опален поликарбонат.

SK · Vonkajšie svetidlo, vyrobené z ocele s bielym opalovým polykarbonátovým difúzorom.



9021

9017

9013



9010



9050

INFO/DIMENSIONS

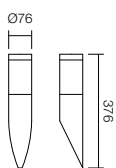

9010

E27, 1 x max. 28W

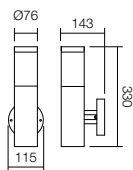

9050

E27, 1 x max. 28W



9013

E27, 1 x max. 28W



9017

E27, 1 x max. 28W

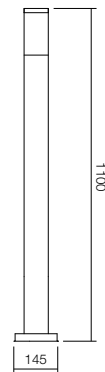

9021

E27, 1 x max. 28W







Adjustable miniprojector for outdoor, housing of die cast aluminum electrostatically painted in dark grey, glass diffuser and plastic accessory for ground installation.

RO · Miniprojector orientabil pentru exterior, corp din aluminiu turnat sub presiune vopsit gri închis, difuzor din sticlă și accesorii din plastic pentru montaj în pământ.

IT · Miniproiettore orientabile da esterni, corpo in pressofusione di alluminio verniciato grigio scuro, diffusore in vetro, equipaggiato con accessorio per fissaggio a terreno.

RU · Регулируемый мини-проектор для наружного освещения, корпус из алюминия литого под давлением, окрашен в электростатическом поле в темно-серый цвет, стеклянный рассеиватель и пластиковый аксессуар для наземного монтажа.

HU · Kültéri mozgatható mini fényvető, szürke nyomás alatt öntött alumínium szerkezet, üveg diszperzór, műanyag tartozék a földbe való rögzítéshez.

BG · Регулируем мини прожектор за екстериор, тяло от алуминий, лят под налягане, в цвят тъмно сиво, стъклен дифузер и пластмасов аксесоар за монтаж в земята.

SK · Nastavitelný miniprojektör pre vonkajšie použitie, kryt z tlakovo liateho hliníka elektrostaticky lakovaný v tmavo šedej farbe, sklenený difúzor a plastové príslušenstvo pre inštaláciu na zem.



INFO/DIMENSIONS

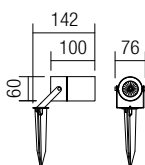

90183



90183

GU10, 1 x max. 35W



Tim



Adjustable miniprojectors for outdoor equipped with SMD LEDs, housing of black polypropylene, transparent polycarbonate diffuser. Delivered with base for wall/ceiling installation and spike for ground fixing.

RO · Miniproiectoare orientabile pentru exterior echipate cu LED-uri SMD, corp din polipropilenă neagră, dispersor din policarbonat transparent. Se livrează cu bază pentru montaj pe tavan/perete și accesoriu de fixat în pământ.

IT · Miniproiettori orientabili da esterni equipaggiati con LED SMD, corpo in polipropilene nero, diffusore in policarbonato trasparente. Viene fornito con basetta per installazione a parete/soffitto ed accessorio per fissaggio a terreno.

RU · Ориентируемые мини прожектора для наружного освещения, оснащенные светодиодами SMD, корпус из черного полипропилена, рассеиватель из прозрачного поликарбоната. Поставляются с основанием для настенного или потолочного монтажа и приспособлением для установки на газон.

HU · Kültéri mozgatható minifényvetők, SMD LED-el ellátva, fekete polipropilén szerkezet, áttetsző polikarbonát diszperzór. Szállítva mennyezetre/falra szerelhető szerkezettel, mellékelve egy földi rögzítéshez való tartozékkal.

BG · Екстериорен насочващ минипрожектор, оборудван с SMD диоди, корпус от черен полипропилен и прозрачен поликарбонатен дифузер. Доставка се с основа за монтаж на стена/тѐван или шип за земя.

SK · Nastavitelné exteriérové miniprojektory, vybavené LED diódami SMD, z čierneho polypropylénu, transparentný polykarbonátový difúzor. Dodáva sa so základňou pre montáž na stenu/ strop a hrot na upevnenie na zemi.



9998



9997

INFO/DIMENSIONS

Standard dimensions

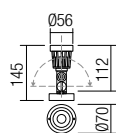

Dimensions + pichet

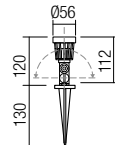

3000K



9997

SMD LED · 5W
3000K · CRI 85
LED flux 445 lm
Luminaire flux 400 lm



4000K



9998

SMD LED · 5W
4000K · CRI 85
LED flux 465 lm
Luminaire flux 420 lm





Outdoor or indoor recessed floor or wall spot. Die cast aluminum body with tempered glass diffuser, external frame made out of steel. It handles a stationary load of maximum 2000 Kg and a dynamic load of a car passing with a maximum speed of 25 km/h. Black thermoplastic housing included.

RO - Spot de încastrat în pardoseală sau perete, pentru exterior sau interior. Corp din aluminiu turnat sub presiune cu dispersor din sticlă temperată, ramă exterioară din inox. Suportă o sarcină statică de maxim 2000 Kg și se poate trece cu mașina cu o viteză maximă de 25 km/h. Carcasa din termoplastice de culoare negru inclusă.

IT - Faretto ad incasso per pavimento o parete, da esterni e interni. Corpo in pressofusione di alluminio con diffusore in vetro temperato, cornice esterna in acciaio inox. Supporta un carico statico massimo di 2000 Kg e il passaggio di una autovettura con una velocità massima di 25 km/h. Controcassa di posa in opera in materiale termoplastico di colore nero inclusa.

RU - Встраиваемое в потолок или в стену световое пятно для внешнего/внутреннего освещения. Тело из алюминия, литого под давлением, диффузор из закаленного стекла. Поддерживает статическую нагрузку не более 2000 кг и можно проезжать на машине с максимальной скоростью 25 км/ч. Оснащено термопластичным каркасом чёрного цвета.

HU - Padlóba vagy falba beépítendő szpot, bel- vagy kültéri használatra. Nyomás alatt öntött alumíniumtest, temperált üveg diszperzórral, inox kerettel. Állóképessége leg több 2000 K, autóval legfeljebb 25 k/h-s sebességgel lehet rajta áthaladni. Hőre ellenálló műanyag burkolata fekete színű.

BG - Спот за вграждане в под или стена, външно или вътрешно. Алюминиево тяло, отливо под налягане, с разпръсквач от temperирано стъкло, външна рамка от неръждаема стомана. Поддържа максималното статично натоварване от 2000 Кг и може да пътува с автомобил с максимална скорост от 25 км/ч. Черниата термoplastична кутия включени.

SK - Vonkajšie alebo interiérové zapustené svetlo do zeme alebo na stenu. Hliníkový odliatok, difúzor z tvrdeného skla, vonkajší rám vyrobený z ocele. Zvládne statické zaťaženie maximálne 2000 kg a je odolné prejedniu autom s maximálnou rýchlosťou 25 km / h. Čierna termoplastická montážna krabica je súčasťou.



9236



9237

INFO/DIMENSIONS

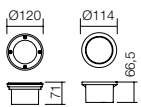

9236

GX53, 1 x max. 9W

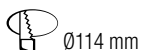

Ø114 mm

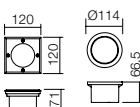

9237

GX53, 1 x max. 9W

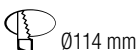

Ø114 mm





9236



9385



9386

INFO/DIMENSIONS

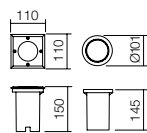
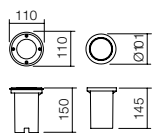

9385
GU10, 1 x max. 28W



Ø101 mm



9386
GU10, 1 x max. 28W



Ø101 mm



Danubia



Outdoor wall lamps, die cast aluminium body electrostatically painted in dark grey or in rust finishing, opal polycarbonate diffuser.

RO · Aplice pentru exterior, corp din aluminiu turnat sub presiune vopsit în câmp electrostatic culoare gri închis sau finisat rugină și dispersor din policarbonat opal.

IT · Applique per esterni, corpo in pressofusione di alluminio verniciato a polveri grigio scuro o con finitura ruggine, diffusore in policarbonato opalino.

RU · Бра для наружного освещения, корпус из литого под давлением алюминия, окрашен в электростатическом поле в темно-серый или с эффектом ржавчины, рассеиватель из опалового поликарбоната.

HU · Kültéri falikarok, elektrosztatikus mezőben sötétszürkérev festett vagy patinásított, nyomás alatt öntött alumínium szerkezet, opál polikarbonát diszperzór.

BG · Външни стени лампи, алуминиеви корпуси с электростатично боядисване в тъмно сиво или с ръжда, полипропилен с оптичен поликарбонат.

SK · Exteriérové nástenné svietidlá, hliníkový odliatok lakovaný v tmavošedej farbe alebo s povrchovou úpravou hrdzavou, opálový polykarbonátový difúzor.



9094



9095

INFO/DIMENSIONS

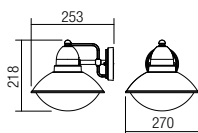

● 9094 Dark Grey

● 9095 Rust

E27, 1 x max. 42W





9095

Edmond



Series of outdoor lighting fixtures, die cast aluminum body electrostatically painted in mat black, transparent polycarbonate diffusers.



9156

RO · Serie de corpuri de iluminat pentru exterior, structură din aluminiu turnat sub presiune, vopsită în câmp electrostatic negru mat, dispersoare din policarbonat transparent.

IT · Serie di apparecchi d'illuminazione per esterni, corpo in pressofusione di alluminio, verniciato a polveri colore nero opaco, diffusori in policarbonato trasparente.

RU · Серия светильников для наружного освещения, конструкция из алюминия, литого под давлением, окрашенная в электростатическом поле черного матового цвета, диффузоры из прозрачного поликарбоната.

HU · Kültéri világítótest, elektrosztatikus térben matfeketére festett, nyomás alatt öntött alumínium szerkezettel, áttetsző polikarbonát diszperzókkal.

BG · Серия екстериорни осветителни тела, структура от алуминий, лят под налягане, боядисан в матово черно электростатично поле, разсейватели от прозрачен поликарбонат.

SK · Sériá vonkajšich svietidiel, hliníkový odliatok elektrostaticky lakovaný v matne čiernej farbe, priehľadný polykarbonátový difúzor.





INFO/DIMENSIONS

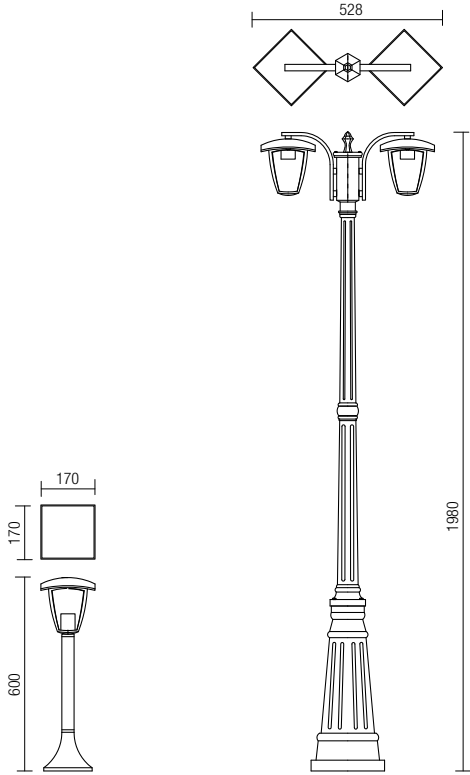

9158

9157



9157

E27, 1 x max. 28W



9158

E27, 2 x max. 28W





9155

INFO/DIMENSIONS

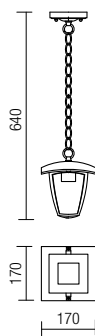
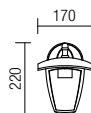
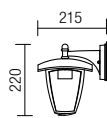
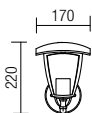
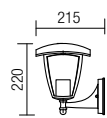

9154

E27, 1 x max. 28W



9155

E27, 1 x max. 28W



9156

E27, 1 x max. 28W



9154

Bristol

Series of outdoor light fittings, die cast aluminium body, antique brown finishing, diffuser in opal polycarbonate.



9958

9957

RO · Serie de corpuri de iluminat pentru exterior, corp din aluminiu turnat sub presiune, finisat maro învechit, dispersor din policarbonat opal.

IT · Serie di lampade per esterni, corpo in pressofusione di alluminio finitura marrone anticato, diffusore in policarbonato opalino.

RU · Серия светильников для наружного освещения, алюминиевый корпус, литый под давлением, отделочный слой античного коричневого цвета с золотой патиной, диффузор из опалового поликарбоната.

HU · Kültéri világítótестek sorozata, nyomás alatt öntött alumínium test, régies barna kivitelezéssel, opálos polikarbonát diszperzór.

BG · Серия екстериорни осветителни тела, тяло от алуминий, лят под налягане, антично кафяво покритие, разсейвател от поликарбонат опал.

SK · Rad vonkajších svietidiel, hliníkový odliatok, starožitný hnedý povrch, difúzor z opálového polykarbonátu.

INFO/DIMENSIONS

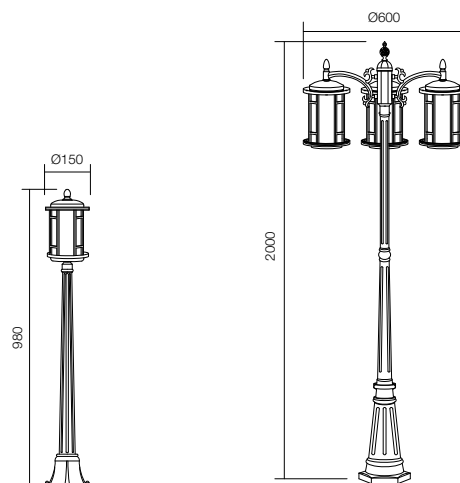

9958

E27, 1 x max. 42W



9957

E27, 3 x max. 42W





Bristol



9955

INFO/DIMENSIONS

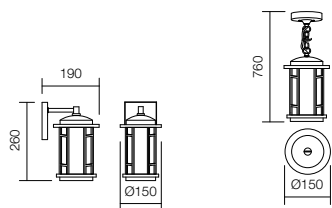

9955
E27, 1 x max. 42W



9956
E27, 1 x max. 42W





9956



9047

9048

Series of outdoor lamps, die cast aluminum and metal structure electrostatically painted in black with copper patina finishing, transparent glass diffuser.

RO · Serie de corpuri de iluminat pentru exterior, structură din aluminiu turnat sub presiune și metal vopsit în câmp electrostatic negru cu patină cupru, dispersor din sticlă transparentă.

IT · Serie di lampade per esterni, struttura in pressofusione di alluminio e metallo verniciato a polveri, finitura nero patinato rame, diffusori in vetro trasparente.

RU · Серия светильников для наружного освещения, со структурой из алюминия литого под давлением и металла окрашенного в электростатическом поле в черный цвет с медной патиной, рассеиватель из прозрачного стекла.

HU · Kültéri világítótestek, nyomás alatt öntött alumínium és elektrosztatikus mezőben fekete és antik réz színűre festett fémszerkezet, áttetsző üveg diszperzor.

BG · Серия екстериорни осветителни тела, структура от алуминий, лят под налягане и метал, електростатично боядисан в черно с медна патина, разсейвател от прозрачно стъкло.

SK · Sériá vonkajších svietidiel z hliníkového odliatku a kovovej konštrukcie elektrostaticky maľovaných na čiernom povrchom s medenou patinou, priehľadné sklenené difúzory.

INFO/DIMENSIONS

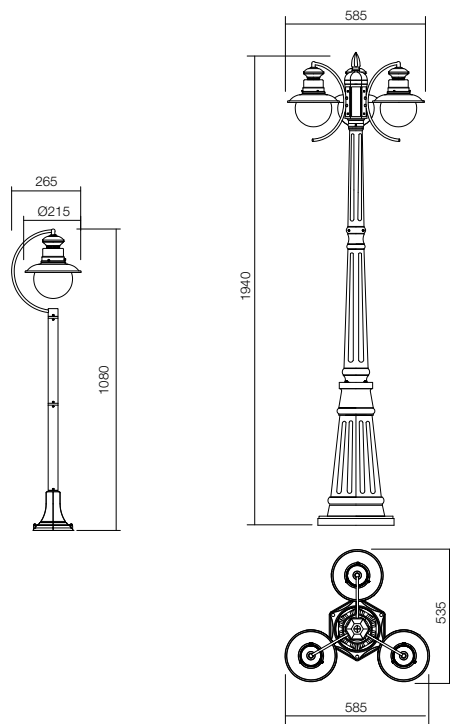

9047

E27, 1 x max. 42W



9048

E27, 3 x max. 42W





9048



9045



9046

INFO/DIMENSIONS

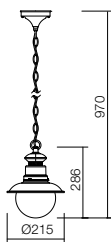
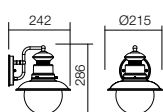

9045

E27, 1 x max. 42W



9046

E27, 1 x max. 42W





9045

Tirol

Outdoor series of lamps, die cast aluminum in rust patina finishing, glass diffuser.

RO · Serie de corpuri de iluminat pentru exterior, corp din aluminiu turnat sub presiune, finisaj rugină, dispersor sticlă.

IT · Serie di lampade per esterni, corpo in pressofusione di alluminio finitura ruggine, diffusore in vetro.

RU · Серия осветительных тел для внешнего освещения, тело из алюминия, литого под давлением, отделочный слой ржавого цвета, стеклянный диффузор.

HU · Kültéri világítótestek sorozata, nyomás alatt öntött alumíniumtest, rozsdás fényezésel, üveg diszperzőrral.

BG · Серия външни осветителни тела, алуминиево тяло, отливо под налягане, покритие ръжда, стъклен разпръсквач.

SK · Vonkajšia séria svietidiel, hliníkový odliatok, hrdzavá patina, sklený difúzor.



9263

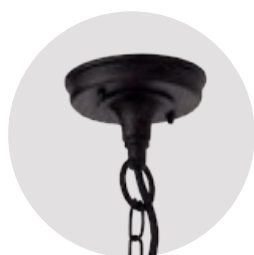

9264

INFO/DIMENSIONS

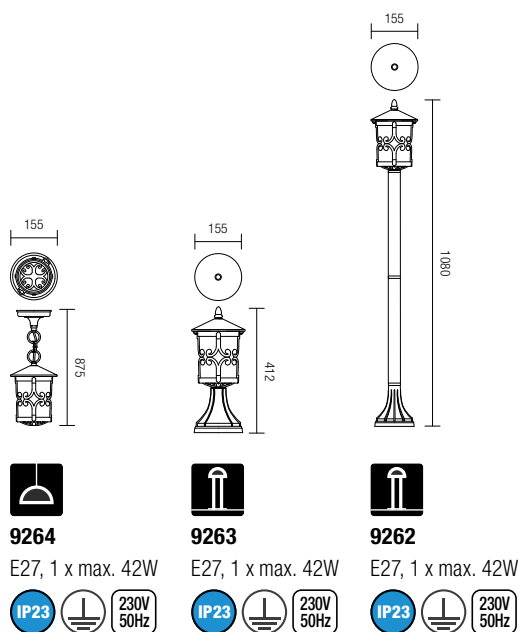





9261

INFO/DIMENSIONS

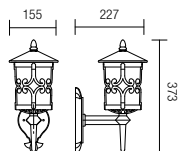
**9259**

E27, 1 x max. 42W

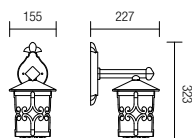
**9260**

E27, 1 x max. 42W

**9261**

E27, 1 x max. 42W





9260



9259

Bari

Series of outdoor wall lamps, die cast aluminum body black finish with copper patina, polycarbonate diffuser.

RO · Serie de lămpi pentru exterior, corp din aluminiu turnat sub presiune finisaj negru cu patină cupru, dispersor din policarbonat.

IT · Serie di lampade per esterni, corpo in pressofusione di alluminio finitura nero patinato rame, diffusore in policarbonato.

RU · Серия ламп для внешнего освещения, тело из алюминия, литого под давлением, отделочный слой чёрного цвета с медной патиной, диффузор из поликарбоната.

HU · Kültéri lámpacsaládt, nyomás alatt öntött alumínium lámpatest fekete-réz patinás fényezés, polikarbonát diszperzór.

BG · Серия външни лампи, алуминево тяло, отливо под налягане, черно покритие с медна патина, разпръсквач от поликарбонат.

SK · Rad vonkajších nástenných svietidiel, hliníkový odliatok v čiernom prevedení s medenou patinou, polykarbonátový difúzor.

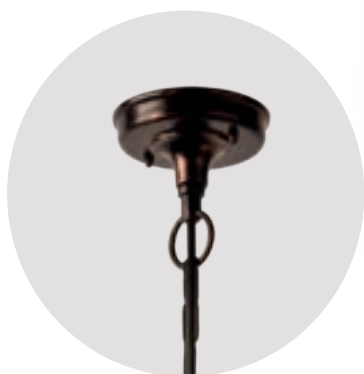

9841



9840



INFO/DIMENSIONS

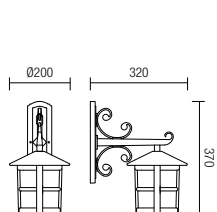

9839

E27, 1 x max. 42W

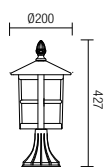

9840

E27, 1 x max. 42W

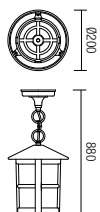

9841

E27, 1 x max. 42W



9839

Melton



Series of light fixtures for outdoor, die cast aluminium structure finished in mat white with gold patina, transparent glass diffusers.

RO · Serie de corpuri de iluminat pentru exterior, structură din aluminiu turnat, finisaj alb mat cu patină aurie, dispersoare din sticlă transparentă.

IT · Serie di apparecchi da esterni, corpo in pressofusione di alluminio finitura bianco opaco patinato oro, diffusori in vetro trasparente.

RU · Серия светильников для наружного освещения, структура из алюминия литого под давлением, окрашенного в белый цвет с золотой патиной, рассеиватели из прозрачного стекла.

HU · Kültéri lámpatestek, matt fehér antik arany öntött alumínium szerkezet, áttetsző üveg diszperzór.

BG · Серия от екстериорни осветителни тела, основа от лят алуминий, бяло матово покритие със златна патина и прозрачен стъклен дифузер.

SK · Sériá exteriérových svietidiel, hliníková konštrukcia z liateho odliatku v matnej bielej farbe so zlatou patinou, difúzory z priehľadného skla.



9675



9676



9675



9710



9711

INFO/DIMENSIONS

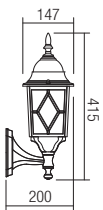

9674

E27, 1 x max. 42W

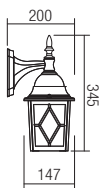

9675

E27, 1 x max. 42W

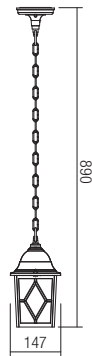

9676

E27, 1 x max. 42W

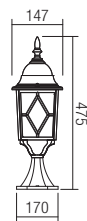

9710

E27, 1 x max. 42W

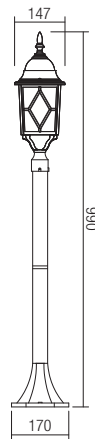

9711

E27, 1 x max. 42W



Bremen



Series of outdoor light fittings, body in die cast aluminium, black with gold patina finish, diffusers in ornamental glass with bubble model.

RO · Serie de lămpi pentru exterior, corp din aluminiu turnat sub presiune, finisaj negru cu patină aurie, dispersoare din sticlă ornamentală cu efect bule de aer.

IT · Serie di lampade per esterni, corpo in pressofusione di alluminio finitura nero patinato oro, diffusori in vetro effetto bolle.

RU · Серия светильников для наружного освещения, алюминиевый корпус, литый под давлением, отделочный слой чёрного цвета с золотой патиной, декоративные стеклянные диффузоры с пузырьковым эффектом.

HU · Kültéri lámpasorozat, nyomás alatt öntött alumínium test, aranyozott patinával, fekete kivitelezéssel, díszítő üveg diszperzór légbuborék effektussal.

BG · Серия екстериорни лампи, тяло от алуминий, лят под напрежение, черно покритие със златиста патина, разсейватели от стъкло, украсено с ефект въдушни мехурчета.

SK · Rad vonkajších svietidiel z liateho hliníka, čierne so zlatou patinou, difúzory z okrasného skla s bublinami.



9952



9951



9953



9961



9954

INFO/DIMENSIONS

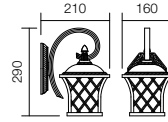

9951

E27, 1 x max. 42W

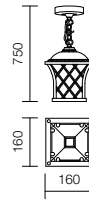

9952

E27, 1 x max. 42W

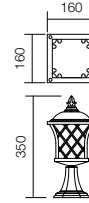

9953

E27, 1 x max. 42W

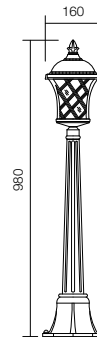

9961

E27, 1 x max. 42W

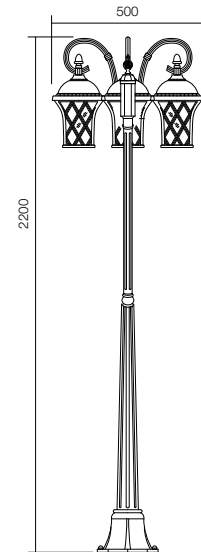

9954

E27, 3 x max. 42W



Matera



Light fixtures for outdoor, metal structure finished in black with copper patina, cognac tinted "water glass" diffuser.

RO · Serie de corpuri de iluminat pentru exterior, structură din metal finisat negru cu patină cupru, dispersor din sticlă tip "water glass" culoare cognac.

IT · Apparecchi per esterni, struttura in metallo finitura nero con patina di rame, diffusore in vetro tipo "water glass" cognac.

RU · Серия светильников для наружного освещения, структура из металла отделанного в черный цвет с медной патиной, рассеиватель с эффектом "мокрого стекла" коньячного цвета.

HU · Kültéri lámpatestek, fekete réz patina fémszerkezet, konyak színű "water glass" típusú diszperzór.

BG · Екстериорни осветителни тела, метална структура, завършена в черно с медна патина, дифузер от оцветено "водно стъкло".

SK · Exteriérové svietidlá, kovová konštrukcia v čiernom prevedení s medenou patinou, koňakom tónovaným difúzorom "vodného skla".



9600

INFO/DIMENSIONS

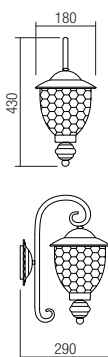

9600

E27, 1 x max. 42W

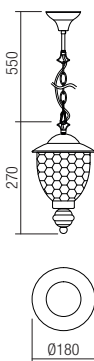

9632

E27, 1 x max. 42W

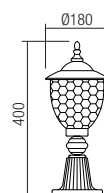

9633

E27, 1 x max. 42W

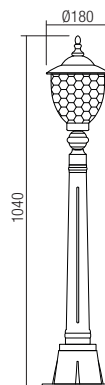

9634

E27, 1 x max. 42W





9632



9634



9633

Sevilla



Outdoor lamps, die cast aluminum body antique black finish with gold patina, trimmed transparent glass diffusers.

RO · Serie de lămpi pentru exterior, corp din aluminiu turnat sub presiune finisat negru antic cu patină aur, dispersoare din sticlă fațetată transparentă.

IT · Lampade da esterni, corpo in pressofusione di alluminio finitura nero patinato oro, diffusori in vetro molato trasparente.

RU · Серия светильников для наружного освещения, алюминиевый корпус, литый под давлением, отделочный слой античного чёрного цвета с золотой патиной, диффузоры из прозрачного граненого стекла.

HU · Kültéri lámpák sorozata, nyomás alatt öntött alumínium test, antik festés aranyozott fénnel, áttetsző csiszolt üveg diszperzörök.

BG · Серия екстериорни лампи, тяло от алуминий, лят под налягане, покритие в антично черно със златна патина, разсейватели от прозрачно фасетирано стъкло.

SK · Vonkajšie lampy, hliníkový odliatok v čiernom prevedení so zlatou patinou, priehľadné sklo.



9605



9604



INFO/DIMENSIONS

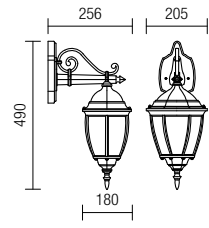

9605

E27, 1 x max. 42W

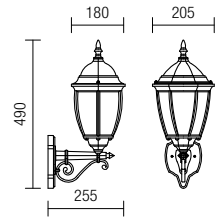

9604

E27, 1 x max. 42W



9607

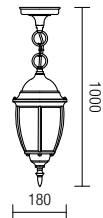

9607

E27, 1 x max. 42W



Sevilla



9606



9608



9609

INFO/DIMENSIONS

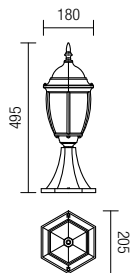

9606

E27, 1 x max. 42W

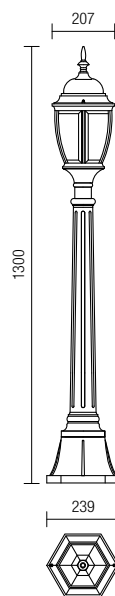

9608

E27, 1 x max. 42W

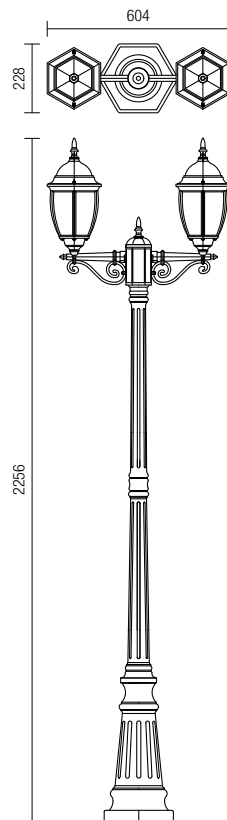

9609

E27, 2 x max. 42W





9609

Avignon

Series of outdoor light fittings, body in die cast aluminium electrostatically painted with antique brown finishing, diffusers of ornamental glass with bubble model.

RO · Serie de corpuri de iluminat pentru exterior, corp din aluminiu turnat sub presiune, vopsit în câmp electrostatic, finisat maro învechit, dispersoare din sticlă ornamentală cu efect bulă de aer.

IT · Serie di lampade per esterni, corpo in pressofusione di alluminio finitura marrone anticato, diffusore in vetro effetto bolle.

RU · Серия светильников для наружного освещения, алюминиевый корпус, литый под давлением, окрашенный в электростатическом поле, отделочный слой античного коричневого цвета, декоративные стеклянные диффузоры с пузырьковым эффектом.

HU · Kültéri világítótestek sorozata, nyomás alatt öntött alumínium test, elektrosztatikus mezőben festve, régies barna kivitelezéssel, díszítő üveg diszperzór légbuborék effektussal.

BG · Серия екстериорни осветителни тела, тяло от алуминий, лят под налягане, боядисано в электростатично поле, с антично кафяво покритие, разсейватели от стъкло, украсено с ефект въздушни мехурчета.

SK · Rad vonkajších svietidiel, liaty hliník, lakované v elektrostatickom poli, starožitná hnedá úprava, difúzory - ornamentálne sklá s bublinami.



9959



INFO/DIMENSIONS

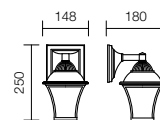

9960

E27, 1 x max. 42W



9959

E27, 1 x max. 42W





9960

General index

<u>01-239</u>	344	<u>01-1171</u>	106	<u>01-1306</u>	82	<u>01-1479</u>	46
<u>01-398</u>	344	<u>01-1172</u>	106	<u>01-1307</u>	82	<u>01-1508</u>	166
<u>01-474</u>	134	<u>01-1176</u>	156	<u>01-1370</u>	179	<u>01-1509</u>	126
<u>01-475</u>	132	<u>01-1177</u>	156	<u>01-1371</u>	179	<u>01-1510</u>	126
<u>01-476</u>	132	<u>01-1178</u>	156	<u>01-1372</u>	179	<u>01-1511</u>	126
<u>01-477</u>	135	<u>01-1179</u>	156	<u>01-1373</u>	181	<u>01-1512</u>	126
<u>01-543</u>	345	<u>01-1239</u>	340	<u>01-1374</u>	181	<u>01-1513</u>	102
<u>01-544</u>	345	<u>01-1240</u>	340	<u>01-1375</u>	183	<u>01-1514</u>	102
<u>01-627</u>	134	<u>01-1245</u>	160	<u>01-1380</u>	191	<u>01-1518</u>	119
<u>01-694</u>	342	<u>01-1246</u>	160	<u>01-1381</u>	191	<u>01-1519</u>	119
<u>01-695</u>	342	<u>01-1247</u>	160	<u>01-1382</u>	191	<u>01-1526</u>	330
<u>01-697</u>	341	<u>01-1255</u>	98	<u>01-1383</u>	191	<u>01-1527</u>	330
<u>01-698</u>	341	<u>01-1256</u>	98	<u>01-1384</u>	191	<u>01-1566</u>	149
<u>01-781</u>	164	<u>01-1257</u>	98	<u>01-1385</u>	191	<u>01-1567</u>	149
<u>01-854</u>	178	<u>01-1258</u>	97	<u>01-1387</u>	196	<u>01-1568</u>	149
<u>01-855</u>	178	<u>01-1259</u>	97	<u>01-1388</u>	196	<u>01-1569</u>	111
<u>01-856</u>	178	<u>01-1260</u>	97	<u>01-1389</u>	159	<u>01-1570</u>	109
<u>01-857</u>	178	<u>01-1261</u>	91	<u>01-1390</u>	159	<u>01-1571</u>	109
<u>01-858</u>	178	<u>01-1262</u>	92	<u>01-1391</u>	159	<u>01-1572</u>	109
<u>01-887</u>	129	<u>01-1263</u>	92	<u>01-1392</u>	335	<u>01-1573</u>	111
<u>01-888</u>	129	<u>01-1264</u>	92	<u>01-1423</u>	334	<u>01-1574</u>	111
<u>01-1002</u>	195	<u>01-1265</u>	92	<u>01-1424</u>	334	<u>01-1575</u>	113
<u>01-1003</u>	195	<u>01-1266</u>	91	<u>01-1429</u>	332	<u>01-1576</u>	113
<u>01-1004</u>	195	<u>01-1278</u>	84	<u>01-1430</u>	332	<u>01-1577</u>	113
<u>01-1026</u>	195	<u>01-1279</u>	84	<u>01-1431</u>	332	<u>01-1578</u>	115
<u>01-1027</u>	136	<u>01-1281</u>	84	<u>01-1455</u>	87	<u>01-1579</u>	115
<u>01-1028</u>	136	<u>01-1283</u>	85	<u>01-1456</u>	87	<u>01-1580</u>	115
<u>01-1029</u>	136	<u>01-1284</u>	85	<u>01-1457</u>	87	<u>01-1621</u>	60
<u>01-1042</u>	171	<u>01-1285</u>	338	<u>01-1458</u>	87	<u>01-1636</u>	40
<u>01-1051</u>	170	<u>01-1286</u>	338	<u>01-1459</u>	86	<u>01-1637</u>	40
<u>01-1052</u>	122	<u>01-1289</u>	199	<u>01-1460</u>	86	<u>01-1638</u>	40
<u>01-1053</u>	122	<u>01-1290</u>	199	<u>01-1461</u>	86	<u>01-1639</u>	40
<u>01-1054</u>	123	<u>01-1291</u>	199	<u>01-1462</u>	86	<u>01-1640</u>	40
<u>01-1097</u>	170	<u>01-1292</u>	199	<u>01-1464</u>	186	<u>01-1641</u>	40
<u>01-1098</u>	170	<u>01-1293</u>	199	<u>01-1467</u>	160	<u>01-1642</u>	40
<u>01-1170</u>	106	<u>01-1294</u>	199	<u>01-1468</u>	186	<u>01-1643</u>	40

<u>01-1644</u>	43	<u>01-1843</u>	184	<u>01-2146</u>	78	<u>01-2188</u>	46
<u>01-1645</u>	43	<u>01-1933</u>	74	<u>01-2147</u>	78	<u>01-2189</u>	46
<u>01-1659</u>	76	<u>01-1934</u>	74	<u>01-2148</u>	78	<u>01-2190</u>	45
<u>01-1660</u>	76	<u>01-1935</u>	74	<u>01-2149</u>	78	<u>01-2191</u>	45
<u>01-1661</u>	76	<u>01-1936</u>	74	<u>01-2150</u>	78	<u>01-2192</u>	105
<u>01-1662</u>	76	<u>01-1937</u>	74	<u>01-2151</u>	78	<u>01-2193</u>	105
<u>01-1663</u>	146	<u>01-1938</u>	74	<u>01-2152</u>	78	<u>01-2194</u>	105
<u>01-1664</u>	147	<u>01-1939</u>	68	<u>01-2153</u>	78	<u>01-2195</u>	105
<u>01-1665</u>	147	<u>01-1940</u>	68	<u>01-2154</u>	78	<u>01-2238</u>	56
<u>01-1666</u>	147	<u>01-1968</u>	146	<u>01-2155</u>	78	<u>01-2239</u>	56
<u>01-1667</u>	94	<u>01-1969</u>	146	<u>01-2156</u>	78	<u>01-2240</u>	56
<u>01-1668</u>	94	<u>01-1990</u>	100	<u>01-2157</u>	78	<u>01-2241</u>	56
<u>01-1669</u>	94	<u>01-1991</u>	100	<u>01-2158</u>	78	<u>01-2304</u>	48
<u>01-1670</u>	150	<u>01-2119</u>	175	<u>01-2159</u>	78	<u>01-2305</u>	48
<u>01-1671</u>	328	<u>01-2120</u>	175	<u>01-2160</u>	78	<u>01-2306</u>	48
<u>01-1672</u>	328	<u>01-2121</u>	175	<u>01-2161</u>	78	<u>01-2307</u>	51
<u>01-1673</u>	328	<u>01-2122</u>	175	<u>01-2162</u>	78	<u>01-2308</u>	51
<u>01-1674</u>	328	<u>01-2123</u>	180	<u>01-2163</u>	83	<u>01-2309</u>	51
<u>01-1675</u>	328	<u>01-2124</u>	180	<u>01-2164</u>	83	<u>01-2310</u>	51
<u>01-1676</u>	328	<u>01-2125</u>	72	<u>01-2165</u>	83	<u>01-2311</u>	51
<u>01-1677</u>	328	<u>01-2126</u>	72	<u>01-2166</u>	83	<u>01-2312</u>	51
<u>01-1678</u>	328	<u>01-2127</u>	182	<u>01-2171</u>	70	<u>01-2313</u>	51
<u>01-1745</u>	163	<u>01-2128</u>	176	<u>01-2172</u>	70	<u>01-2314</u>	51
<u>01-1746</u>	163	<u>01-2129</u>	174	<u>01-2173</u>	71	<u>01-2315</u>	51
<u>01-1747</u>	169	<u>01-2130</u>	174	<u>01-2174</u>	88	<u>01-2316</u>	51
<u>01-1748</u>	169	<u>01-2131</u>	174	<u>01-2175</u>	124	<u>01-2317</u>	51
<u>01-1749</u>	169	<u>01-2132</u>	174	<u>01-2176</u>	124	<u>01-2318</u>	51
<u>01-1762</u>	62	<u>01-2137</u>	152	<u>01-2177</u>	124	<u>01-2319</u>	130
<u>01-1763</u>	62	<u>01-2138</u>	152	<u>01-2180</u>	336	<u>01-2320</u>	130
<u>01-1764</u>	62	<u>01-2139</u>	152	<u>01-2181</u>	336	<u>01-2321</u>	130
<u>01-1835</u>	177	<u>01-2140</u>	155	<u>01-2182</u>	58	<u>01-2322</u>	130
<u>01-1836</u>	177	<u>01-2141</u>	154	<u>01-2183</u>	58	<u>01-2323</u>	118
<u>01-1837</u>	177	<u>01-2142</u>	155	<u>01-2184</u>	58	<u>01-2324</u>	118
<u>01-1838</u>	177	<u>01-2143</u>	78	<u>01-2185</u>	58	<u>01-2325</u>	118
<u>01-1841</u>	184	<u>01-2144</u>	78	<u>01-2186</u>	58	<u>01-2326</u>	118
<u>01-1842</u>	184	<u>01-2145</u>	78	<u>01-2187</u>	58	<u>01-2335</u>	232

General index

<u>01-2336</u>	233	<u>01-2456</u>	52	<u>02-844</u>	220	<u>04-438</u>	310
<u>01-2337</u>	232	<u>01-2457</u>	52	<u>02-845</u>	220	<u>04-439</u>	310
<u>01-2341</u>	233	<u>01-2458</u>	65	<u>02-934</u>	225	<u>04-456</u>	298
<u>01-2342</u>	233	<u>01-2459</u>	65	<u>02-935</u>	225	<u>04-457</u>	298
<u>01-2343</u>	66	<u>01-2460</u>	65	<u>02-936</u>	225	<u>04-458</u>	298
<u>01-2344</u>	66	<u>01-2617</u>	120	<u>02-937</u>	225	<u>04-459</u>	298
<u>01-2345</u>	66	<u>01-2618</u>	120	<u>02-939</u>	213	<u>04-467</u>	291
<u>01-2346</u>	66	<u>01-2619</u>	121	<u>02-960</u>	212	<u>04-468</u>	291
<u>01-2347</u>	172	<u>01-2620</u>	121	<u>02-961</u>	212	<u>04-469</u>	291
<u>01-2348</u>	172	<u>01-2621</u>	121	<u>02-966</u>	210	<u>04-470</u>	291
<u>01-2399</u>	140	<u>01-2622</u>	121	<u>02-967</u>	210	<u>04-471</u>	291
<u>01-2400</u>	140	<u>01-2623</u>	116	<u>02-968</u>	210	<u>04-472</u>	291
<u>01-2401</u>	140	<u>01-2624</u>	116	<u>02-969</u>	206	<u>04-473</u>	291
<u>01-2402</u>	140	<u>01-2625</u>	116	<u>02-970</u>	206	<u>04-474</u>	291
<u>01-2403</u>	141	<u>01-2626</u>	116	<u>02-971</u>	206	<u>04-475</u>	308
<u>01-2404</u>	141	<u>01-2627</u>	116	<u>02-972</u>	206	<u>04-476</u>	308
<u>01-2405</u>	141	<u>01-2628</u>	34	<u>02-973</u>	206	<u>04-477</u>	308
<u>01-2406</u>	142	<u>01-2629</u>	34	<u>02-974</u>	208	<u>04-478</u>	308
<u>01-2407</u>	142	<u>01-2630</u>	37	<u>02-975</u>	208	<u>04-479</u>	305
<u>01-2408</u>	142	<u>01-2631</u>	37	<u>02-976</u>	208	<u>04-480</u>	305
<u>01-2409</u>	80	<u>01-2632</u>	37	<u>02-977</u>	208	<u>04-481</u>	305
<u>01-2410</u>	80	<u>01-2633</u>	37	<u>02-978</u>	215	<u>04-482</u>	305
<u>01-2411</u>	80	<u>01-2634</u>	37	<u>02-979</u>	215	<u>04-483</u>	306
<u>01-2412</u>	80	<u>01-2635</u>	37	<u>02-980</u>	215	<u>04-484</u>	306
<u>01-2413</u>	80	<u>01-2636</u>	39	<u>02-981</u>	215	<u>04-485</u>	306
<u>01-2414</u>	80	<u>01-2637</u>	39	<u>04-372</u>	313	<u>04-486</u>	306
<u>01-2415</u>	145	<u>01-2638</u>	39	<u>04-373</u>	313	<u>04-499</u>	303
<u>01-2416</u>	145	<u>01-2639</u>	39	<u>04-374</u>	313	<u>04-500</u>	303
<u>01-2417</u>	145	<u>02-642</u>	202	<u>04-375</u>	313	<u>04-501</u>	303
<u>01-2418</u>	145	<u>02-643</u>	202	<u>04-421</u>	320	<u>04-502</u>	303
<u>01-2450</u>	230	<u>02-709</u>	218	<u>04-422</u>	320	<u>04-503</u>	325
<u>01-2451</u>	230	<u>02-710</u>	218	<u>04-423</u>	322	<u>04-504</u>	325
<u>01-2452</u>	231	<u>02-711</u>	218	<u>04-424</u>	322	<u>04-505</u>	325
<u>01-2453</u>	54	<u>02-712</u>	218	<u>04-425</u>	322	<u>04-506</u>	293
<u>01-2454</u>	54	<u>02-713</u>	218	<u>04-436</u>	310	<u>04-507</u>	293
<u>01-2455</u>	54	<u>02-714</u>	218	<u>04-437</u>	310	<u>04-508</u>	293

<u>04-509</u>	293	<u>05-391</u>	280	<u>05-872</u>	270	<u>05-920</u>	234
<u>04-510</u>	316	<u>05-395</u>	280	<u>05-873</u>	269	<u>05-921</u>	240
<u>04-511</u>	316	<u>05-565</u>	276	<u>05-874</u>	269	<u>05-922</u>	252
<u>04-512</u>	316	<u>05-566</u>	276	<u>05-875</u>	269	<u>05-923</u>	252
<u>04-513</u>	316	<u>05-567</u>	276	<u>05-876</u>	269	<u>05-924</u>	248
<u>04-514</u>	318	<u>05-572</u>	128	<u>05-877</u>	269	<u>05-925</u>	246
<u>04-515</u>	318	<u>05-573</u>	128	<u>05-880</u>	284	<u>05-926</u>	242
<u>04-516</u>	301	<u>05-574</u>	128	<u>05-881</u>	284	<u>05-928</u>	254
<u>04-517</u>	301	<u>05-677</u>	280	<u>05-882</u>	284	<u>05-929</u>	254
<u>04-518</u>	301	<u>05-681</u>	280	<u>05-883</u>	284	<u>05-930</u>	254
<u>04-519</u>	294	<u>05-705</u>	277	<u>05-884</u>	259	<u>05-931</u>	254
<u>04-520</u>	294	<u>05-706</u>	277	<u>05-885</u>	259	<u>05-932</u>	254
<u>04-521</u>	294	<u>05-707</u>	277	<u>05-886</u>	259	<u>05-933</u>	254
<u>04-522</u>	294	<u>05-811</u>	275	<u>05-895</u>	278	<u>05-934</u>	251
<u>04-523</u>	296	<u>05-812</u>	275	<u>05-896</u>	278	<u>05-935</u>	251
<u>04-524</u>	296	<u>05-813</u>	275	<u>05-897</u>	278	<u>05-936</u>	251
<u>04-525</u>	296	<u>05-840</u>	274	<u>05-898</u>	278	<u>05-937</u>	251
<u>04-526</u>	296	<u>05-841</u>	274	<u>05-899</u>	278	<u>05-938</u>	251
<u>05-085</u>	286	<u>05-844</u>	261	<u>05-900</u>	278	<u>05-939</u>	251
<u>05-086</u>	286	<u>05-845</u>	261	<u>05-903</u>	272	<u>05-940</u>	251
<u>05-088</u>	286	<u>05-846</u>	261	<u>05-904</u>	272	<u>05-941</u>	251
<u>05-089</u>	286	<u>05-847</u>	265	<u>05-905</u>	272	<u>05-942</u>	251
<u>05-091</u>	286	<u>05-848</u>	265	<u>05-906</u>	256	<u>05-943</u>	251
<u>05-092</u>	286	<u>05-849</u>	265	<u>05-907</u>	256	<u>05-944</u>	251
<u>05-364</u>	282	<u>05-850</u>	264	<u>05-908</u>	256	<u>05-945</u>	251
<u>05-365</u>	282	<u>05-851</u>	264	<u>05-909</u>	267	<u>05-946</u>	251
<u>05-366</u>	282	<u>05-852</u>	264	<u>05-910</u>	267	<u>05-947</u>	251
<u>05-367</u>	282	<u>05-853</u>	258	<u>05-911</u>	267	<u>06-001</u>	205
<u>05-368</u>	282	<u>05-854</u>	258	<u>05-912</u>	266	<u>06-002</u>	205
<u>05-369</u>	282	<u>05-855</u>	258	<u>05-913</u>	266	<u>06-003</u>	204
<u>05-370</u>	282	<u>05-856</u>	260	<u>05-914</u>	262	<u>06-004</u>	205
<u>05-371</u>	282	<u>05-857</u>	260	<u>05-915</u>	262	<u>06-005</u>	205
<u>05-378</u>	280	<u>05-868</u>	270	<u>05-916</u>	262	<u>06-006</u>	204
<u>05-382</u>	280	<u>05-869</u>	270	<u>05-917</u>	236	<u>06-032</u>	162
<u>05-385</u>	280	<u>05-870</u>	270	<u>05-918</u>	238	<u>06-033</u>	162
<u>05-389</u>	280	<u>05-871</u>	270	<u>05-919</u>	244	<u>06-034</u>	162

General index

<u>9001</u>	414	<u>9397</u>	400	<u>9787</u>	412	<u>70008</u>	363
<u>9010</u>	416	<u>9452</u>	386	<u>9788</u>	412	<u>70009</u>	363
<u>9013</u>	416	<u>9453</u>	386	<u>9789</u>	412	<u>70010</u>	363
<u>9014</u>	409	<u>9454</u>	386	<u>9790</u>	412	<u>70011</u>	363
<u>9017</u>	416	<u>9455</u>	386	<u>9810</u>	397	<u>70012</u>	363
<u>9021</u>	416	<u>9600</u>	446	<u>9811</u>	397	<u>70013</u>	363
<u>9045</u>	434	<u>9604</u>	449	<u>9812</u>	397	<u>70014</u>	363
<u>9046</u>	434	<u>9605</u>	449	<u>9818</u>	401	<u>70031</u>	370
<u>9047</u>	432	<u>9606</u>	450	<u>9820</u>	400	<u>70057</u>	365
<u>9048</u>	432	<u>9607</u>	449	<u>9839</u>	441	<u>70058</u>	365
<u>9050</u>	416	<u>9608</u>	450	<u>9840</u>	441	<u>70081</u>	363
<u>9094</u>	422	<u>9609</u>	450	<u>9841</u>	441	<u>70082</u>	363
<u>9095</u>	422	<u>9632</u>	446	<u>9866</u>	412	<u>70083</u>	362
<u>9097</u>	408	<u>9633</u>	446	<u>9867</u>	412	<u>70094</u>	363
<u>9154</u>	427	<u>9634</u>	446	<u>9872</u>	412	<u>70095</u>	363
<u>9155</u>	427	<u>9674</u>	443	<u>9873</u>	412	<u>70096</u>	369
<u>9156</u>	427	<u>9675</u>	443	<u>9951</u>	445	<u>70097</u>	369
<u>9157</u>	426	<u>9676</u>	443	<u>9952</u>	445	<u>70098</u>	369
<u>9158</u>	426	<u>9710</u>	443	<u>9953</u>	445	<u>70099</u>	369
<u>9210</u>	401	<u>9711</u>	443	<u>9954</u>	445	<u>70124</u>	381
<u>9236</u>	420	<u>9760</u>	412	<u>9955</u>	430	<u>70125</u>	381
<u>9237</u>	420	<u>9761</u>	412	<u>9956</u>	430	<u>70126</u>	381
<u>9259</u>	438	<u>9764</u>	413	<u>9957</u>	428	<u>70127</u>	381
<u>9260</u>	438	<u>9765</u>	413	<u>9958</u>	428	<u>70141</u>	370
<u>9261</u>	438	<u>9766</u>	413	<u>9959</u>	452	<u>70142</u>	370
<u>9262</u>	436	<u>9767</u>	413	<u>9960</u>	452	<u>70147</u>	366
<u>9263</u>	436	<u>9768</u>	413	<u>9961</u>	445	<u>70148</u>	366
<u>9264</u>	436	<u>9769</u>	413	<u>9997</u>	419	<u>70149</u>	366
<u>9330</u>	396	<u>9770</u>	412	<u>9998</u>	419	<u>70150</u>	366
<u>9352</u>	396	<u>9771</u>	412	<u>70001</u>	363	<u>70151</u>	366
<u>9356</u>	415	<u>9774</u>	413	<u>70002</u>	363	<u>70152</u>	366
<u>9357</u>	415	<u>9775</u>	413	<u>70003</u>	363	<u>70153</u>	367
<u>9358</u>	396	<u>9776</u>	413	<u>70004</u>	363	<u>70154</u>	367
<u>9359</u>	396	<u>9777</u>	413	<u>70005</u>	363	<u>70155</u>	367
<u>9385</u>	421	<u>9779</u>	413	<u>70006</u>	363	<u>70156</u>	367
<u>9386</u>	421	<u>9780</u>	413	<u>70007</u>	363	<u>70157</u>	367

<u>70158</u>	367	<u>70336</u>	364	<u>70382</u>	351	<u>90196</u>	404
<u>70194</u>	369	<u>70337</u>	364	<u>70383</u>	350	<u>90197</u>	404
<u>70195</u>	369	<u>70338</u>	364	<u>70384</u>	350	<u>90198</u>	404
<u>70196</u>	369	<u>70339</u>	364	<u>70385</u>	350	<u>90199</u>	404
<u>70197</u>	369	<u>70340</u>	364	<u>70386</u>	350	<u>90200</u>	404
<u>70220</u>	372	<u>70341</u>	364	<u>70387</u>	351	<u>90201</u>	404
<u>70237</u>	363	<u>70344</u>	375	<u>70388</u>	351	<u>90202</u>	406
<u>70238</u>	363	<u>70349</u>	378	<u>70389</u>	351	<u>90203</u>	406
<u>70288</u>	374	<u>70350</u>	378	<u>70390</u>	350	<u>90204</u>	406
<u>70307</u>	368	<u>70351</u>	379	<u>70391</u>	350	<u>90205</u>	402
<u>70308</u>	368	<u>70352</u>	379	<u>70392</u>	360	<u>90206</u>	402
<u>70309</u>	368	<u>70353</u>	378	<u>70393</u>	360	<u>90207</u>	402
<u>70310</u>	368	<u>70354</u>	378	<u>70394</u>	361	<u>90208</u>	392
<u>70311</u>	373	<u>70355</u>	379	<u>70399</u>	348	<u>90246 Black</u>	406
<u>70313</u>	373	<u>70356</u>	379	<u>70400</u>	348	<u>90279</u>	384
<u>70315</u>	362	<u>70357</u>	376	<u>70401</u>	349	<u>90280</u>	384
<u>70316</u>	354	<u>70358</u>	377	<u>70402</u>	349	<u>90281</u>	394
<u>70317</u>	354	<u>70359</u>	356	<u>70403</u>	380	<u>90282</u>	394
<u>70318</u>	354	<u>70360</u>	356	<u>70404</u>	380	<u>90283</u>	394
<u>70319</u>	354	<u>70361</u>	357	<u>90179</u>	398	<u>90291</u>	388
<u>70320</u>	359	<u>70362</u>	357	<u>90180</u>	398	<u>90293</u>	389
<u>70321</u>	359	<u>70363</u>	352	<u>90181</u>	398		
<u>70322</u>	359	<u>70364</u>	352	<u>90182</u>	398		
<u>70323</u>	359	<u>70365</u>	353	<u>90183</u>	418		
<u>70324</u>	358	<u>70366</u>	353	<u>90184</u>	390		
<u>70325</u>	358	<u>70367</u>	355	<u>90185</u>	390		
<u>70326</u>	358	<u>70368</u>	371	<u>90186</u>	390		
<u>70327</u>	358	<u>70369</u>	371	<u>90187</u>	390		
<u>70328</u>	364	<u>70370</u>	371	<u>90188</u>	390		
<u>70329</u>	364	<u>70371</u>	371	<u>90189</u>	390		
<u>70330</u>	364	<u>70372</u>	371	<u>90190</u>	391		
<u>70331</u>	364	<u>70373</u>	371	<u>90191</u>	391		
<u>70332</u>	364	<u>70378</u>	350	<u>90192</u>	391		
<u>70333</u>	364	<u>70379</u>	350	<u>90193</u>	404		
<u>70334</u>	364	<u>70380</u>	351	<u>90194</u>	404		
<u>70335</u>	364	<u>70381</u>	351	<u>90195</u>	404		

Conformities and Symbols

Conformități și simboluri



CLASS I

Isolation and connection of protection (the luminaire needs earth connection).
Izolație și conexiune de protecție (aparatul necesită împământare).
 Isolamento e connessione di protezione (l'apparecchio necessita di messa a terra).
Защитная изоляция и соединение (предмет требует заземления).
 Védelmi szigetelés és kapcsolat (az eszköz számára szükséges a földelés).
Изоляция и защита връзка (устройството изисква заземяване).
 Izolácia a pripojenie ochrany (svietidlo potrebuje uzemnenie).



CLASS II

Double or enforced isolation (the luminaire doesn't need earth connection).
Izolație dublă sau întărită (aparatul nu necesită împământare).
 Isolamento doppio o rafforzato (l'apparecchio non necessita messa a terra).
Двойная или усиленная изоляция (предмет не требует заземления).
 Dupla vagy megerősített szigetelés (az eszköz számára nem szükséges a földelés).
Двойна или подсилена изолация (устройството не изисква заземяване).
 Dvojité alebo vynútená izolácia (svietidlo nepotrebuje uzemnenie).



CLASS III

Low, undangerous voltage (Luminaire for low voltage only - not exceeding 24V).
Tensiuni mici, nepericuloase (aparatul se conectează numai la tensiuni joase - maxim 24V).
 Tensioni basse, non pericolose. (L'apparecchio si connette con tensione non superiore ai 24V).
Низкие, неопасные напряжения (предмет подключается только к низким напряжениям - не более 24V).
 Alacsony, veszélytelen feszültségek (a készülék csak alacsony feszültséghez csatlakozik - legfeljebb 24V).
Ниски напрежения, неопасни (устройството се свързва само при ниски напрежения - 24V максимум).
 Nízke, bezpečné napätie (svietidlá len pre nízke napätie – nepresahujúce 24V).





Fitting can be installed on normal flammable areas - which temperature of inflammability is over 200° C.
Corpul de iluminat poate fi montat pe suprafețe normal inflamabile - a căror temperatură de inflamabilitate este mai mare de 200° C.
 Apparecchio installabile su superfici infiammabili fino a un massimo di 200° C.
Осветительное тело можно установить на нормально воспламеняющихся поверхностях, температура вспышки которых превышает 200° C.
 A világítóttest felszerelhető a normálisan gyúladható felületekre – amelyek gyúlékonysági hőmérséklet 200° C-nál nagyobb.
Осветительного тѐла може да се монтира на нормално запалими повърхности - чиято температура за запалимост е по-голяма от 200° C.
 Montáž môže byť inštalovaná na horľavých materiáloch – s teplotou vznietenia vyššou ako 200°C.





All the light fixtures, made and commercialized by REDO GROUP, are CE marked and meet the specific directives: 73/25 CEE and 93/68 CEE regarding safety, the directives 89/336 CEE and 93/68 CEE regarding electromagnetic compatibility (EMC).
Toate corpurile de iluminat produse și comercializate de REDO GROUP sunt marcate cu CE și respectă directivele specifice: 73/25 CEE și 93/68 CEE cu privire la siguranță, directivele 89/336 CEE și 93/68 CEE cu privire la compatibilitatea electromagnetică (EMC).
 Tutti gli apparecchi luminosi prodotti e commercializzati da REDO GROUP sono marcati CE e rispettano le direttive specifiche: 73/25 CEE e 93/68 CEE relative alla sicurezza, nonché alle direttive 89/336 CEE e 93/68 CEE relative alla compatibilità elettromagnetica (EMC).
Все осветительные тела, сделанные и реализованные компанией РЕДО ГРУПП маркированы CE и соответствуют специфичным директивам: 73/25 CEE и 93/68 CEE о безопасности, директивам 89/336 CEE и 93/68 CEE о электромагнитной совместимости (EMC).
 A REDO GROUP által gyártott és értékesített összes világítóttestek CE jelölésűek és betartják a szak irányelveket: a biztonságról szóló 73/25 CEE és 93/68 CEE irányelvek és elektromágneses kompatibilitásról (EMC) szóló 89/336 CEE és 93/68 CEE irányelvek.
Всички осветителни уреди, произведени и продадени от РЕДО ГРУП са маркирани CE и са в съответствие със специфичните директиви: 73/25 CEE и 93/68 CEE относно безопасността, директивите 89/336 CEE и 93/68 CEE за електромагнитна съвместимост (EMC)
 Všetky svietidlá vyrobené a uvádzané na trh spoločnosťou REDO GROUP sú označené CE a spĺňajú špecifické smernice: 73/25 CEE a 93/68 CEE o bezpečnosti, smernice 89/336 CEE a 93/68 CEE týkajúce sa elektromagnetickej kompatibility (EMC).

 Chandelier · Candelabru · Lampadario
 Люстра для интерьера · Beltéri csillár
 Канделабра · Interiérový luster

 Suspension · Suspensie · Sospensione
 Подвеска · Felfüggesztés · Окачване
 Zăvesné svietidlá

 Ceiling lamp · Plafonieră · Plafoniera
 Потолочный светильник
 Mennyezeti lámpa · Плафониера
 Stropná lampa

 Wall lamp · Aplică · Applique
 Бра · Falilámpa · Лампа за стена
 Nástenné svietidlá

 Floor lamp · Lampadar · Piantana
 Торшер · Lámpaoszlop · Фенер
 Stojánová lampa

 Table lamp · Veioză · Lampada da tavolo
 Столовая лампа · Lámpa · Лампа
 Stólná lampa

 Pole · Stâlp · Palo
 Столб · Oszlop · Стлб
 Stĺpik

 Recessed luminaire
 Corp de iluminat încadrat
 Apparecchio da incasso
 Встраиваемые светильники
 Süllyesztett lámpatest
 Вграждане осветителя
 Zápustné svietidlá

 Cut-out dimensions for embedding.
 Dimensiune decupare pentru încadrare.
 Dimensioni foro per incasso.
 Размер разрезания для прикрепления.
 A süllyesztés számára való kivágás mérete.
 Размер за рязането за вграждане.
 Rozmer pre montážny otvor.

 Spotlight with vertical orientation.
 Spot cu orientare verticală.
 Apparecchio da incasso a orientamento verticale.
 световое пятно с вертикальным направлением
 Spot függőleges irányításal.
 Спот с вертикално ориентация.
 Spot svietidlá s vertikálnou orientáciou.

 Recessed spotlight floor mounting for outdoor / indoor.
 Spot de încadrat în pardoseală pentru exterior/interior.
 Fareto ad incasso per pavimento da esterni / interni.
 Световое пятно для фиксирования на полу, для наружного или внутреннего освещения.
 Külső / belső számára padlón süllyeszthető szpot.
 Външен/вътрешен спот за вграждане в под.
 Zápustné podlahové svietidlá pre vonkajšie / vnútorné použitie.

 Minimum distance between lamp and the surface or illuminated objects.
 Distanța minimă dintre lampă și suprafață sau obiectele iluminate.
 Distanza minima di rispetto tra lampada e superfici o oggetti illuminati.
 Минимальное расстояние между светильником и освещённой поверхностью или освещёнными предметами.
 A világított tárgy vagy felületek és lámpa közötti legalacsonyabb távolság.
 Минималното разстояние между лампа и осветената зона или осветените обекти.
 Minimálna vzdialenosť medzi svietidlom a nasvietenými objektami

 Not dimmable
 Nu este dimabil
 Non dimmerabile
 Нерегулируемый
 Nem szabályozható
 Не димируема
 Nie je stmievateľná

 Device compatible with REDO SMART and TUYA mobile applications.
 Dispozitiv compatibil cu aplicațiile mobile REDO SMART și TUYA.
 Apparecchio compatibile con le applicazioni mobile REDO SMART e TUYA.
 Устройство совместимо с мобильными приложениями REDO SMART и TUYA.
 A REDO SMART és a TUYA mobil alkalmazásokkal kompatibilis lámpatest.
 Устройство совместимо с мобильными приложениями REDO SMART и TUYA.
 Zariadenie kompatibilné s mobilnými aplikáciami REDO SMART a TUYA.

 Light fixture with Wi-Fi technology.
 Dispozitiv cu tehnologie Wi-Fi.
 Apparecchio con tecnologia Wi-Fi.
 Устройство с технологией Wi-Fi.
 Wi-Fi technológiával rendelkező eszköz.
 Устройство с Wi-Fi технология.
 Zariadenie s technológiou Wi-Fi.

 Luminaire with light color temperature control.
 Dispozitiv cu temperatura de culoare a luminii reglabilă.
 Apparecchio con regolazione della temperatura colore della luce.
 Светильник с регулировкой светлой цветовой температуры.
 Világítóttest világos színhőmérséklet-állításal.
 Осветительное тѐло с регулиране на светлата цветова температура.
 Svietidlo s reguláciou teploty svetla.

 Luminaire with RGB light.
 Corp de iluminat cu lumină RGB.
 Apparecchio con luce RGB.
 Светильник с RGB подсветкой.
 RGB lámpatest.
 Осветительное тѐло с RGB светлина.
 Svietidlo s RGB svetlom.

Color legend

Legendă culori

CODE	ENGLISH	ROMÂNĂ	ITALIANO	РУССКИЙ	MAGYAR	БЪЛГАРСКИ	SLOVENSKÝ
AB	ANTIQUE BRASS	ALAMĂ ANTICĂ	OTTONE ANTICATO	АНТИЧНАЯ ЛАТУНЬ	ANTIK SÁRGARÉZ	АНТИЧЕН МЕСИНГ	ANTICKÁ MOSADZ
AM	AMBER	AMBRA	AMBRA	СЕРЫЙ ЯНТАРЬ	BOROSTYÁNKŐ	КЕХЛИБАР	ANTÁR
BL	BLUE	ALBASTRU	BLU	СИНИЙ ЦВЕТ	KÉK	СИН	MODRÁ
BK	BLACK	NEGRU	NERO	ЧЁРНЫЙ ЦВЕТ	FEKETE	ЧЕРЕН	ČIERNA
BK/CL	BLACK / CRYSTAL	NEGRU / CRISTAL	NERO / CRISTALLO	ХРУСТАЛЬ ЧЁРНОГО ЦВЕТА	FEKETE / KRISTÁLY	ЧЕРНО / КРИСТАЛ	ČIERNA/PRIEHĽADNÁ
CH	CHROME	CROM	CROMO	ХРОМ	KRÓM	ХРОМ	CHRÓM
CL	CLEAR	CRISTAL	CRISTALLO	ХРУСТАЛЬ	KRISTÁLY	КРИСТАЛ	PRIEHĽADNÁ
CL/BK	CRYSTAL / BLACK	CRISTAL / NEGRU	CRISTALLO / NERO	ХРУСТАЛЬ ЧЁРНОГО ЦВЕТА	KRISTÁLY / FEKETE	КРИСТАЛ/ЧЕРНО	KRYŠTÁL/ČIERNA
FR/WH	FROST WHITE	ALB MAT	BIANCO SABBATO	БЕЛЫЙ ЦВЕТ, ОБРАБОТАННЫЙ ПЕСКОСТРУЙНЫМ МЕТОДОМ	HOMOKFŰVOTT FEHÉR	МАТ БЯЛО	STUDENÁ BIELA
GM	BLACK "GUN METAL"	NEGRU "ȚEAVĂ DE PUȘCĂ"	NERO "CANNA DI FUCILE"	ЧЁРНЫЙ ЦВЕТ "ДУЛО РУЖЬЯ"	"PUSKACSÓ" FEKETE	ЧЕРЕН, "БАРЕЛ"	ČIERNA "KOVOVÁ"
MB	MAT BRASS	ALAMĂ MATĂ	OTTONE OPACO	МАТОВАЯ ЛАТУНЬ	FÉNYTELEN SÁRGARÉZ	МАТОВ МЕСИНГ	MAT MESTA
MC	MAT CHROME	CROM SATINAT	CROMO OPACO	САТИНИРОВАННЫЙ ХРОМ	SZATÉNOZOTT KRÓM	САТЕНЕН ХРОМ	MATNÝ CHRÓM
NM	SATIN NICKEL	NICHEL SATINAT	NICHEL SATINATO	САТИНИРОВАННЫЙ НИКЕЛЬ	SZATÉNOZOTT NIKKEL	САТЕНЕН НИКЕЛ	ATÉNOVÝ NIKEL
PB	POLISH BRASS	ALAMĂ LUSTRUITĂ	OTTONE LUCIDO	ПОЛИРОВАННАЯ ЛАТУНЬ	KIFÉNYESÍTETT SÁRGARÉZ	ПОЛИРАН МЕСИНГ	LESKLÁ MOSADZ
PC	PEARL CHROME	PERLĂ CROM	PERLATO CROMO	ЖЕМЧУГ ХРОМ	KRÓM GYÖNGY	ХРОМНА ПЕРЛА	PERLEŢOVÝ CHRÓM
PG	PEARL GOLD	PERLĂ AUR	PERLATO ORO	ЗОЛОТОЙ ЖЕМЧУГ	ARANY GYÖNGY	ЗЛАТНА ПЕРЛА	PERLEŢOVÁ ZLATÁ
PK	PINK	ROZ	ROSA	РОЗОВЫЙ ЦВЕТ	RÓZSASZÍN	РОЗОВ	RUŽOVÁ
PS	PEARL SILVER	PERLĂ ARGINT	PERLATO ARGENTO	СЕРЕБРЕННЫЙ ЖЕМЧУГ	EZÜST GYÖNGY	ПЕРЛА СРЕБРО	PERLEŢOVÁ STRIEBORNÁ
RAB	RED ANTIQUE BRASS	ALAMĂ ROȘIE ANTICĂ	OTTONE ROSSO ANTICATO	АНТИЧНАЯ КРАСНАЯ ЛАТУНЬ	ANTIK VÖRÖS SÁRGARÉZ	ЧЕРВЕН АНТИЧЕН МЕСИНГ	ČERVENÁ ANTICKÁ MOSADZ
S	SILVER	ARGINT	ARGENTO	СЕРЕБРО	EZÜST	СРЕБЪРО	STRIEBORNÁ
SG	SATIN GOLD	AUR SATINAT	ORO SATINATO	САТИНИРОВАННОЕ ЗОЛОТО	SZATÉNOZOTT ARANY	САТЕНЕНО ЗЛАТО	SATÉNOVÁ ZLATÁ
SB	SATIN BRASS	ALAMĂ SATINATĂ	OTTONE SATINATO	САТИНИРОВАННАЯ ЛАТУНЬ	SZATÉNOZOTT SÁRGARÉZ	САТЕНЕН МЕСИНГ	SATÉNOVÁ MOSADZ
GR	GREY	GRI	GRIGIO	СЕРЫЙ ЦВЕТ	SZÜRKE	СИВ	ŠEDÁ
SWH	SATIN WHITE	ALB SATINAT	BIANCO SATINATO	САТИНИРОВАННЫЙ БЕЛЫЙ ЦВЕТ	SZATÉNOZOTT FEHÉR	САТЕНЕН БЯЛ	SATÉNOVÁ BIELA
WH	WHITE	ALB	BIANCO	БЕЛЫЙ ЦВЕТ	FEHÉR	БЯЛ	BIELA
YE	YELLOW	GALBEN	GIALLO	ЖЁЛТЫЙ ЦВЕТ	SÁRGA	ЖЪЛТ	ŽLTÁ
MWH	MATT WHITE	ALB MAT	BIANCO OPACO	БЕЛАЯ МАТОВАЯ	MATT FEHÉR	МАТ БЯЛА	MATNÁ BIELA

IP.. Protection degree

Semnificația gradelor de protecție

IP.. The signification of the figures included in the symbols of the IP protection normal degrees.

Semnificația cifrelor cuprinse în simbolizarea gradelor normale de protecție IP.

Significato delle cifre contenute nella simbologia che indica i gradi di protezione IP.

Обозначение цифр содержащихся в указании нормальных защитных градусов.

Az IP védelmi normális osztályok ábrázolásában bennfoglalt számok jelentése.

Значение на цифрите, включени в символите с нормалния степен на защита IP.

Číselné označenie symbolov IP ochrany.

Prima cifră IP x0

IP1. Protected against the entry of solid bodies with dimensions of more than 50 mm.

Protejat contra corpurilor solide mai mari de 50 mm.

Proteetto contro la penetrazione di corpi solidi di dimensioni superiori a 50 mm.

Защита от твердых тел больше 50 мм.

50mm-nél nagyobb szilárd testek elleni védelem.

Защитен срещу твърди тела по-големи от 50 мм.

Ochrana proti vstupu pevných telies s rozmermi viac ako 50mm.

IP2. Protected against the entry of solid bodies with dimensions of more than 12 mm.

Protejat contra corpurilor solide mai mari de 12mm.

Proteetto contro la penetrazione di corpi solidi di dimensioni superiori a 12 mm.

Защита от твердых тел больше 12 мм.

12 mm-nél nagyobb szilárd testek elleni védelem.

Защитен срещу твърди тела по-големи от 12 мм.

Ochrana proti vstupu pevných telies s rozmermi viac ako 12mm.

IP3. Protected against the entry of solid bodies with dimensions of more than 2,5 mm.

Protejat contra corpurilor solide mai mari de 2,5 mm.

Proteetto contro la penetrazione di corpi solidi di dimensioni superiori a 2,5 mm.

Защита от твердых тел больше 2,5 мм.

2,5 mm-nél nagyobb szilárd testek elleni védelem.

Защитен срещу твърди тела по-големи от 2,5 мм.

Ochrana proti vstupu pevných telies s rozmermi viac ako 2,5mm.

IP4. Protected against the entry of solid bodies with dimensions of more than 1mm.

Protejat contra corpurilor solide mai mari de 1mm.

Proteetto contro la penetrazione di corpi solidi di dimensioni superiori a 1mm.

Защита от твердых тел больше 1мм.

1 mm-nél nagyobb szilárd testek elleni védelem.

Защитен срещу твърди тела по-големи от 1мм.

Ochrana proti vstupu pevných telies s rozmermi viac ako 1mm.

IP5. Protected against entry of dust.

Protejat la praf fără presiune.

Proteetto contro la penetrazione della polvere.

Защита от пыли без давления.

Nyomás nélküli por elleni védelem.

Защитен от прах, без да натискате.

Ochrana proti vniknutiu prachu.

IP6. Completely protected against entry of dust.

Protejat total la praf.

Proteetto completamente contro la penetrazione della polvere.

Полная защита от пыли.

Por ellen teljesen védett.

Напълно защитен от прах.

Kompletná ochrana proti vniknutiu prachu.

A doua cifră IP 0x (protecție la apă)

IP1. Protected against the vertical falling of water drops (condensation).

Protejat la picături de apă care cad vertical (condens).

Proteetto contro le cadute verticali di gocce d'acqua (condensa).

Защита от подающих вертикально каплей воды (конденсат).

Függőlegesen eső vízcseppek elleni védelem (cseppfolyósítás).

Защитен от вертикално падане на водните капки (кондензация).

Chránené proti vertikálne padajúcim vodným kvapkám (kondenzácia).

IP2. Protected against the falling of water with maximum inclination of 15°.

Protejat la picături de apă care cad până la 15° față de verticală.

Proteetto contro le cadute dell'acqua con inclinazione massima di 15°.

Защита от дожди, с каплями до угла 15° к вертикали.

A függőlegeshez viszonyítva 15°-ig eső vízcseppek elleni védelem.

Защитен от водните капки, които ронят до 15° от вертикалната.

Chránené proti padajúcej vode pod maximálnym uhlom 15°.

IP3. Protejat la ploaie, cu stropi până la 60° față de verticală.

Protected against the falling of water with maximum inclination of 60°.

Proteetto contro le cadute dell'acqua con inclinazione massima di 60°.

Защита от дожди, с каплями до угла 60° к вертикали.

A függőlegeshez viszonyítva 60°-ig eső vízcseppek elleni védelem.

Защитен от дъжд, с капки до 60° от вертикалната.

Chránené proti padajúcej vode pod maximálnym uhlom 60°.

IP4. Protected against the water drops that come from all directions.

Protejat contra stropilor de apă care ajung din toate direcțiile.

Proteetto contro le gocce d'acqua provenienti da tutte le direzioni.

Защита от подающих из всех направлений каплей воды.

Az összes irányokból jövő vízcseppek elleni védelem.

Защитен срещу водни капки, които достигат от всички посоки.

Chránené pred vodnými kvapkami prichádzajúcich zo všetkých strán.

IP5. Protected against water jets from all directions with p=0.3 bar.

Protejat împotriva jeturilor de apă din toate direcțiile cu p=0.3 bar.

Proteetto contro i getti d'acqua provenienti da tutte le direzioni con p=0.3 bar.

Защита от водяных струев от всех направлений с давлением = 0,3 бар.

Minden irányból érkező vízsugarak 0.3 bar nyomás elleni védelem.

Защитен срещу водни струи от всички посоки с p = 0,3 бара.

Chránené pred vodnými lúčmi zo všetkých smerov s p=0,3 bar.

IP6. Protected against water jets from all directions.

Protejat împotriva jeturilor de apă din toate direcțiile.

Proteetto contro getti d'acqua provenienti da tutte le direzioni.

Защита от водяного струя от всех направлений.

Minden irányból érkező vízsugarak nyomás elleni védelem.

Защитен срещу водни струи от всички посоки.

Chránené pred vodnými lúčmi zo všetkých strán.

IP7. Protected against the water immersion up to 1m.

Protejat la imersie în apă până la 1m.

Proteetto contro l'immersione in acqua fino a 1m.

Защита от погружения в воду до 1м.

Védett a vízben való merülésre 1 m-ig.

Защитен от водно потапяне на 1 метър.

Chránené proti ponoreniu do vody až do 1m.

IP8. Protected against the prolonged immersion effect to depths higher than 1m.

Protejat la efectul imersiei prelungite la adâncimi mai mari de 1m.

Proteetto contro gli effetti dell'immersione prolungata a profondità superiore a 1m.

Защита от воздействия длительного погружения при глубинах больше 1м.

Védett az 1 m-nél nagyobb mélységek hosszabb merülés hatása ellen.

Защитен от продължително водно потапяне при по-големи от 1 метър дълбочини.

Chránené pred dlhotrvajúcim ponorením do hĺbky väčšej ako 1m.

Quality and Certification Certificări



REDO GROUP received the certification of the Quality System Management SR EN ISO 9001:2008 from the SRAC IQNET certification body, recognized in the world.

The obtaining of the certificate for REDO GROUP and for its clients, represents a further warranty that the processes and the activities made internally are regulated by norms that insure the prescribed qualitative standards.

REDO GROUP a primit certificarea Sistemului de Management al Calității SR EN ISO 9001: 2008 din partea organismului de certificare SRAC IQNET recunoscut la nivel mondial.

Obținerea certificării pentru REDO GROUP și pentru clienții săi, constituie o garanție în plus pentru faptul că procesele și activitățile desfășurate pe plan intern sunt reglementate de norme care asigură standardele calitative prescise.

REDO GROUP ha conseguito la certificazione del Sistema di Management per la Qualità SR EN ISO 9001:2008 da parte dell'ente di certificazione SRAC IQNET riconosciuto a livello mondiale.

L'ottenimento della certificazione per REDO GROUP e per i suoi clienti, costituisce ulteriore garanzia che i processi e le attività svolte all'interno, sono disciplinati da normative che assicurano gli standard qualitativi previsti.

РЕДО ГРУПП получил сертификат Системы Менеджмента Качества SR EN ISO 9001: 2008 со стороны органа сертификации SRAC IQNET, пользующегося мировым признанием.

Получение сертификации для РЕДО ГРУПП и своих клиентов является последующей гарантией, чтобы процессы и развитые внутри деятельности регламентируют нормы, обеспечивающие предусмотренные стандарты по качеству.

REDO GROUP a világon elismert SRAC IQNET tanúsító szervezet által kiállított EN ISO 9001: 2008 Minőségirányítási Rendszer tanúsítványt megszerzte.

A REDO GROUP és ügyfeleinek számára való tanúsítvány megszerzése egy utólagos garancia arra, hogy belsőben fejlesztett folyamatok és tevékenységek szabályozva vannak az előírt minőségi szabványok biztosító előírások által.

РЕДО ГРУП е получил сертифициране за Система за Управление на Качеството SR EN ISO 9001: 2008 от световния орган за сертификация IQNET SRAC.

Получаване на сертифициране за РЕДО ГРУП и за своите клиенти представлява допълнителна гаранция, че развитите вътрешно процеси и дейности се управляват от правила, които гарантират предписаните стандарти за качество.

Spoločnosť REDO GROUP získala certifikát systému manažérstva kvality SR EN ISO 9001:2008 od certifikačného orgánu SRAC IQNET uznávaného vo svete.

Získanie certifikátu pre spoločnosť REDO GROUP a jej klientov predstavuje ďalšiu záruku, že procesy a činnosti vykonávané interne sú regulované normami, ktoré zabezpečujú predpísané kvalitatívne štandardy.

REDO GROUP products meet the European Directive (2002/95/EC) regarding all the electric and electronic devices sold in the Member States of the European Union after the 1st of July 2006. The purpose of the directive is that of limiting the use of some dangerous substances in equipments and establishing an adequate warning and administrative system for these wastes, encouraging the recovery and the separate collection.

Produsele REDO GROUP respectă Directiva Europeană (2002/95/EC) cu privire la toate echipamentele electrice și electronice vândute în Țările membre ale Uniunii Europene după 1 iulie 2006. Scopul directivei este cel de a limita folosirea unor substanțe periculoase în echipamente și de a stabili un sistem de prevenire și gestiune a unor astfel de reziduuri, favorizând recuperarea/reciclarea și colectarea diferențiată.

I prodotti REDO GROUP rispettano la Direttiva europea (2002/95/EC) che riguarda tutte le apparecchiature elettriche ed elettroniche vendute negli Stati membri dell'Unione Europea dopo il 1 luglio 2006. Scopo della direttiva è quello di limitare l'impiego di alcune sostanze pericolose nelle apparecchiature e predisporre un apposito sistema di prevenzione e di gestione di tali rifiuti, favorendo il recupero/riciclaggio e la raccolta differenziata.

Продукты РЕДО ГРУПП соответствуют Европейской Директиве (2002/95/EC) о всем электрическом и электронном оборудовании, реализованном в Странах – Членах Евросоюза после 1 июля 2006 г. Целью директивы состоит в ограничении использования опасных веществ при производстве оборудования и в определении системы предупреждения и управления такими остатками, способствуя получению обратно/ утилизацию и /дифференцированное собиране.

REDO GROUP termékek megfelelnek 2006. július 1. után Európai Unió tagországokban értékesített valamennyi elektromos és elektronikus berendezésekről szóló Európai irányelvnek (2002/95/EC). Az irányelv célja, hogy korlátozza a veszélyes anyagok felhasználást a berendezésekben és az ilyen hulladékok megelőzési és kezelési rendszer létrehozása, támogatva a hasznosítást / újrahaznosítást és a különített összegyűjtést.

Продуктите РЕДО ГРУП спазват Европейската Директива (2002/95/EC) за всички електрически и електронни уреди, продавани в Сраните-членки на Европейския Съюз след 1 юли, 2006 г. Директивата има за цел да се ограничи употребата на опасни вещества в оборудване и да създава система за превенция и управление на такива отпадъци, като се насърчава оползотворяване / рециклиране и разнообразно събиране.

Výrobky spoločnosti REDO GROUP spĺňajú Európsku Smernicu (2002-95/EC), ktorá sa týka všetkých elektrických a elektronických zariadení predávaných v členských štátoch Európskej únie po 1.júli 2006. Cieľom smernice je obmedziť používanie niektorých nebezpečných látok v zariadeniach zavedením primeraného varovného a administratívneho systému pre tieto odpady, podporovaním obnovy a separovaného zberu.





REDO GROUP srl

Str. Alexei Tolstoi, 12
600093 Bacău

ROMÂNIA

Tel. +40 234 562452 / 514492 / 546620

Fax +40 234 546677

office@redogroup.ro

www.smarterlight.ro

www.redogroup.com

REDO GROUP ITALIA srl

Via Gelsomini, 4
31100 Treviso (TV)

Tel/fax +39 0422 1847197

info@redogroup.it

www.redogroup.it

www.redogroup.it

Design: Itro Studio

Photo: Deborah Sandrin

Supporto tecnico Luca Paulicelli

Print: Grafiche Antiga

This catalogue cannot be copied or reproduced by any other means.

All rights reserved.

Acest catalog nu poate fi copiat sau reprodus prin orice alte mijloace.

Toate drepturile rezervate.

While maintaining the basic characteristic of the products, the manufacturer reserves the right to make modifications at any time with the sole aim of improvement.

Mentținând caracteristica de bază a produselor, producătorul își rezervă dreptul de a face modificări în orice moment, cu unicul scop de îmbunătățire.